

RADIO'S GREATEST MAGAZINE

December

25 Cents

In United States
and Canada

OVER 175 ILLUSTRATIONS

38

Radio-Craft

HUGO GERNSBACK EDITOR

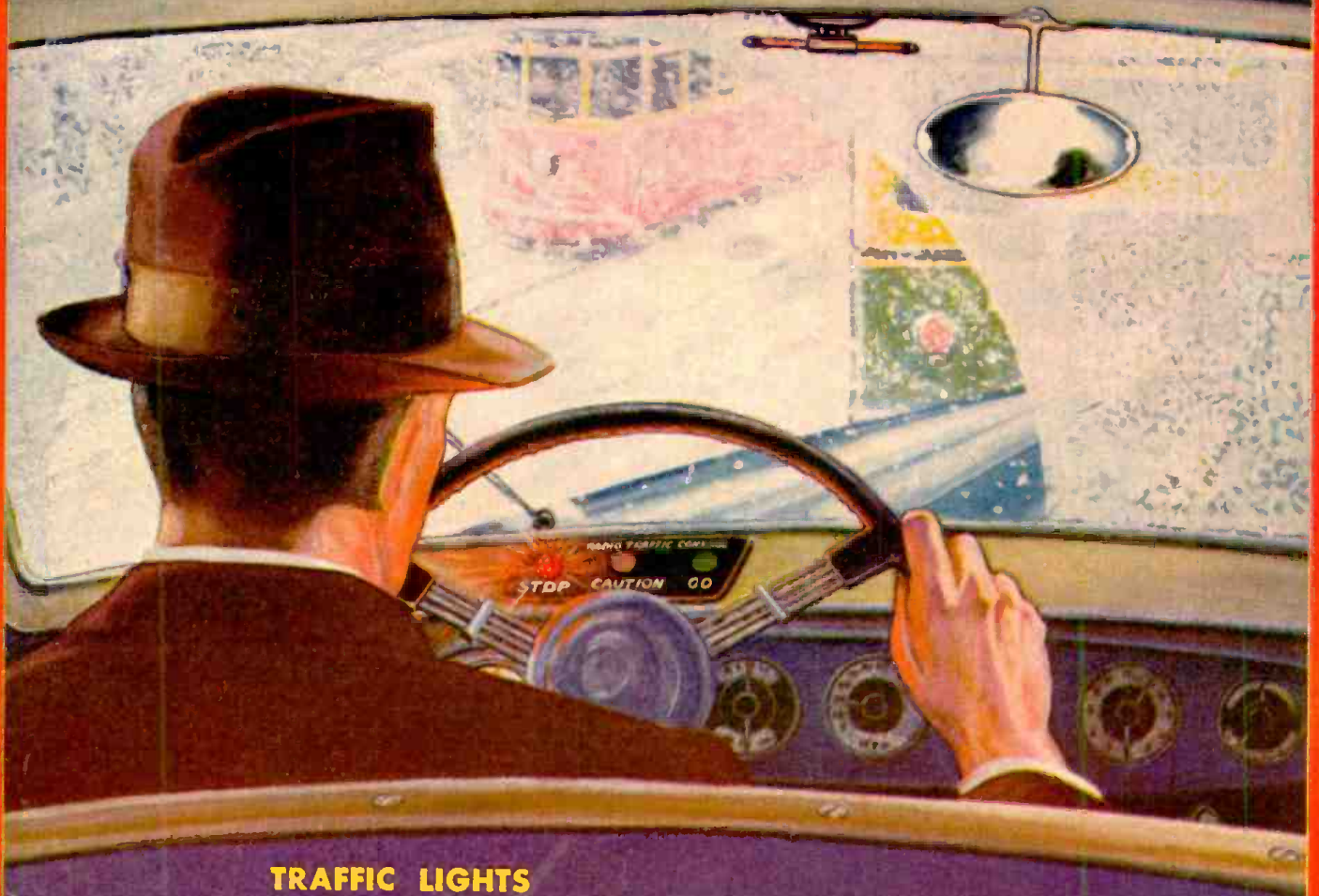

TRAFFIC LIGHTS

In Your Car

—BY RADIO

See Page 328

Newest 1939 Tubes • Build the Servicemen's "Super-Geno-Scope" Test Unit
Experiments with Multivibrators • Play Talkies Through Your Radio Set

OVER 50,000 RADIO MEN READ RADIO-CRAFT MONTHLY

The **AMPERITE**

ACOUSTIC COMPENSATOR

(pat. pend.)

gives you

HIGH OR LOW PITCH

WITH THE SAME MICROPHONE

BIGGER PROFITS To be ahead of competition, and realize a larger profit on each job, you must offer added value in new features. Realizing this, *Amperite* gives you *The Acoustic Compensator* . . . at no extra cost to you!

This is an exclusive feature which enables you to (1) lower or raise the response of the microphone; (2) adjust for close talking or distant pickup; (3) adapt microphone to varied conditions.

THESE 4 MODELS HAVE THE ACOUSTIC COMPENSATOR

MODEL RBHk (hi-imp); **RBMk** (200 ohms) Frequency range 40 to 11000 CPS. Output -65 db. . . . Chrome or Gunmetal . . \$42.00 LIST

NEW! MODEL RSHk (hi-imp); **RBSk** (200 ohms) Frequency range 60 to 8000 CPS. Output -68 db. . . . Chrome or Gunmetal . . \$32.00 LIST

All of the above are complete with Acoustic Compensator, Switch, Cable Connector, and cable.

NOTE: Roth Sound Service writes. . . "Your mikes are certainly rugged. I've used them in rain, wind, and on the hottest days, but they've always stood up perfectly".



PUSH UP TO INCREASE HIGHS; PUSH DOWN TO INCREASE LOWS



IMPROVES ANY "LOW-COST" INSTALLATION ON 4 COUNTS!

P.A. Men, you can improve those "price" jobs by using the popular *Amperite* Model

RAH (or **RAL**). You will get better results because: (1) it is excellent for both speech and music; (2) has flat response without undesirable peaks; (3) reduces feedback; (4) stands up under rain, wind, heat, and rough handling . . . Frequency range 60 to 7500 CPS. Output -68 db. **MODEL RAH** (hi-imp); with 12' of cable; **MODEL RAL** (200 ohms) with 8' of cable. . . . \$22.00 LIST

MAKE EXTRA SALES WITH CONTACT MIKES...\$12.00 LIST

Professional and amateur musicians are delighted with the *Amperite* Contact Microphone. It "makes an ordinary violin sound like a Strad" . . . gives a small piano the tone of a grand. And yet, there is no distortion. No unnatural effects. No "fingering noises". . . . Frequency response 40 to 9000 CPS. Output -40 db. 20' of cable.

Models listed below can be used on most radio sets since 1935 and on all P.A. Systems. They operate with either high or low gain amplifiers. Installation is simple . . . no changes in strings or instruments . . . attached without tools.

MODEL SKH (Hi-imp); **SKL** (200 ohms) . \$12.00 LIST
SKH or **SKL** with foot-operated volume control . . . \$20.00 LIST
 Professional Model **KTH** (or **KTL**) . . . \$22.00 LIST

A COMPACT VELOCITY for hand or stand

Though only a little larger than a match box, this *Amperite* Velocity has the features of the larger microphones. Good for speech and music. Designed for use on stand, but also makes an excellent hand microphone with comfortable pistol grip.

Frequency response 60 to 7500 CPS. Output -70 db. Complete with switch, cable connector, and 25' of cable.

MODEL ACH (hi-imp); or **ACL** (200 ohms) . . . \$25.00 LIST

Sales Aids for the P. A. Man *Amperite* offers the following co-operation to P.A. Men.

- (1.) FREE Window Decal advertising your Sound Service. Size 5 1/4 x 9 1/4, finished in 4 striking colors.
- (2.) FREE Window Display, 11 x 17.
- (3.) Special Sound Equipment Letterheads. Samples and prices on request.
- (4.) FREE use of cut for printing business cards, etc.

Write for these valuable sales helps, and new Illustrated Bulletins, today!



AMPERITE ©, 561 BROADWAY, N. Y. U. S. A. CABLE ADDRESS ALKEM, NEW YORK



VELOCITY **AMPERITE** MICROPHONES

A FREE LESSON SHOWED BILL HOW HE COULD MAKE GOOD PAY IN RADIO

BILL, YOU'RE ALWAYS FOOLING WITH RADIO -- OUR SET WON'T WORK -- WILL YOU FIX IT?

I'LL TRY, MARY, I'LL TAKE IT HOME TONIGHT

I CAN'T FIND OUT WHAT'S WRONG -- GUESS I'LL MAKE A FOOL OF MYSELF WITH MARY

HELLO, BILL -- GOT A TOUGH ONE TO FIX? LET ME HELP YOU

HELLO JOE -- WHERE'VE YOU BEEN LATELY -- AND WHERE DID YOU LEARN ANYTHING ABOUT RADIO?

I'VE BEEN STUDYING RADIO AT HOME, BILL, WITH THE NATIONAL RADIO INSTITUTE. YOU OUGHT TO TAKE THEIR COURSE. I'VE GOT A GOOD RADIO JOB NOW. LET'S MAKE A CIRCUIT DISTURBANCE TEST -- STARTING WITH THE AUDIO OUTPUT STAGE AND TESTING EVERY STAGE RIGHT BACK TO THE ANTENNA. LISTEN FOR THE CLICKS WHEN I TAP THE GRID LEADS

SAY -- WHERE DID YOU LEARN THAT TEST? IT'S A GOOD ONE

HERE'S THE TROUBLE, BILL, IN THE FIRST I.F. AMPLIFICATION STAGE. I LEARNED THAT TEST EVEN BEFORE I STARTED TAKING THE COURSE, BILL. IT'S DESCRIBED IN A FREE LESSON WHICH THE NATIONAL RADIO INSTITUTE SENDS YOU WHEN YOU MAIL A COUPON FROM ONE OF THEIR ADS

I'VE SEEN THEIR ADS BUT I NEVER THOUGHT I COULD LEARN RADIO AT HOME -- I'LL MAIL THEIR COUPON RIGHT AWAY

I'M CONVINCED NOW THAT THIS COURSE IS PRACTICAL AND COMPLETE. I'LL ENROLL NOW AND THEN I CAN MAKE REAL MONEY FIXING RADIO SETS OR INSTALL AND SERVICE LOUD SPEAKER SYSTEMS

OR GET A JOB WITH A RADIO BROADCASTING OR TRANSMITTING STATION

AVIATION RADIO, POLICE RADIO, TELEVISION, ELECTRONIC CONTROLS -- RADIO IS SURELY GOING PLACES. AND THE NATIONAL RADIO INSTITUTE HAS TRAINED HUNDREDS OF MEN FOR JOBS IN RADIO

I will send you a Lesson on Radio Servicing Tips FREE TO SHOW HOW PRACTICAL IT IS TO TRAIN AT HOME FOR GOOD JOBS IN RADIO



YOU CERTAINLY KNOW RADIO SOUNDS AS GOOD AS THE DAY I BOUGHT IT.

THANKS! IT CERTAINLY IS EASY TO LEARN RADIO THE N.R.I. WAY. I STARTED ONLY A FEW MONTHS AGO, AND I'M ALREADY MAKING GOOD MONEY.

THIS SPARE TIME WORK IS GREAT FUN AND PRETTY SOON I'LL BE READY FOR A FULL TIME JOB

OH BILL -- I'M SO GLAD I ASKED YOU TO FIX OUR RADIO. IT GOT YOU STARTED THINKING ABOUT RADIO AS A CAREER, AND NOW YOU'RE GOING AHEAD SO FAST

OUR WORRIES ARE OVER. I HAVE A GOOD JOB NOW, AND THERE'S A BIG FUTURE AHEAD FOR US IN RADIO

J. E. SMITH, PRESIDENT, DEPT. 8NX NATIONAL RADIO INSTITUTE, WASHINGTON, D. C.

Dear Mr. Smith: Without obligation, send me a sample lesson and your free book which points out spare time and full time radio opportunities, and shows how I can train for them at home in spare time about the N.R.I. Set Servicing Instrument you give. (Please write plainly.)

Name Age

Address

City State

14X-1

Clip the coupon and mail it. I will prove I can train you at home in your spare time to be a RADIO EXPERT. I will send you my first lesson FREE. Examine it, read it, see how clear and easy it is to understand--how practical I make learning Radio at home. Men without Radio or electrical knowledge become Radio Experts, earn more money than ever as a result of my training.

Why Many Radio Experts Make \$30, \$50, \$75 a Week

Radio broadcasting stations employ engineers, operators, station managers and pay up to \$5,000 a year. Fixing Radio sets in spare time pays many \$200 to \$500 a year--full time jobs with Radio jobs, manufacturers and dealers as much as \$30, \$50, \$75 a week. Many Radio Experts open full or part time Radio sales and repair businesses. Radio manufacturers and jobbers employ testers, inspectors, foremen, engineers, servicemen and pay up to \$6,000 a year. Auto, mobile, police, aviation, commercial Radio, loud speaker systems are newer fields offering good opportunities now and for the future. Television promises to open many good jobs soon. Men I trained have good jobs in these branches of Radio. Read how they got their jobs. Mail coupon.

Many Make \$5, \$10, \$15 a Week Extra in Spare Time While Learning

The day you enroll I start sending Extra Money Job Shows; show you how to do Radio repair jobs. Throughout your training I send plans and directions that made good spare time money--\$200 to \$500--for hundreds, while learning. I send you special Radio equipment to conduct experiments and

build circuits. This 50-50 method of training makes learning at home interesting, fascinating, practical.

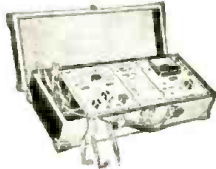

I Also Give You This Professional Servicing Instrument

Here is the instrument every Radio expert needs and wants an All-Wave, All-Purpose, Set Servicing Instrument. It contains everything necessary to measure A.C. and D.C. voltages and current; to test tubes, resistance, adjust and align any set, old or new. It satisfies your needs for professional servicing after you graduate--can help you make extra money fixing sets while training.

Get Sample Lesson and 64 page Book FREE -- Mail Coupon

In addition to my Sample Lesson, I will send you my 64-page book, "Rich Rewards in Radio." Both are FREE to anyone over 16 years old. My book points out Radio's spare time and full time opportunities and those coming in Television; tells about my Training in Radio and Television; shows you letters from men I trained, telling what they are doing and earning; shows my Money Back Agreement. MAIL THE COUPON in an envelope, or paste it on a penny postcard.

J. E. Smith, Pres., National Radio Institute Dept. 8NX, Washington, D. C.

J. E. SMITH
President
National Radio Institute
Established 1914

The man who has directed the home study training of more men for the Radio Industry than any other man in America.

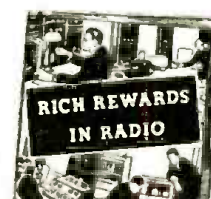

Please Say That You Saw It in RADIO-CRAFT



HUGO GERNSBACK, Editor-in-Chief

R. D. WASHBURNE
Managing Editor

N. H. LESSEM
Associate Editor

ROBERT EICHBERG
Trade Digest Editor

THOS. D. PENTZ, Art Director

CONTENTS—Dec. 1938, Issue

Volume X

Number 6

Editorial: The Radio Tube Age.....	Hugo Gernsback	325
The Radio Month in Review.....		326
Traffic Lights in Your Car—By Radio!	Albert E. Sindlinger	328
New Tubes for 1939.....	R. D. Washburne	330
Play Talkies Through Your Radio Receiver —Part I	Jack Robins	336
Servicing Questions & Answers.....		339
Operating Notes		339
U. S. Army P.A. System Has 1-Mile Rangel.....		340
Manhole Loudspeakers.....	W. E. Shrage	340
10 x 12 Foot, 441-Line Scan-Disc Television!.....		341
Making a Serviceman's Test Unit—The "Super-Geno- Scope"—Part I.....	Canio Maggio	342

"Cash Register" Tube Tester.....Samuel C. Milbourne 344

Novel Ideas in Radio Sets..... 345-346

Experiments with Multivibrators..Charles Sicuranza 347-348

RADIO SERVICE DATA SHEETS:

No. 241—General Electric Models G-105 and
G-106 350

No. 242—Ditto 351

New Circuits in Modern Radio Receivers—No. 15
.....F. L. Sprayberry 352

Radio Trade Digest..... 353

The Latest Radio Equipment..... 357

Book Reviews 372 and 375

IN THE NEXT ISSUE —

Newest developments in short-waves and ultra-shortwaves will be described in January RADIO-CRAFT. Also articles of interest to technicians in the fields of Television, Electronics, Public Address and Servicing will appear.

Do not miss the first article in a series of outstanding interest to every reader of RADIO-CRAFT; this article—which opens to Servicemen what promises to be the biggest moneymaker in 1939!—describes for prospective home owners, and for architects and builders—

THE "AVERAGE AMERICAN HOME" —WIRED FOR RADIO!

Published by Radcraft Publications, Inc. Publication office: 29 Worthington Street, Springfield, Mass. Editorial and Advertising Offices: 99 Hudson Street, New York City. Chicago Advertising Office: RADIO-CRAFT, 520 North Michigan Avenue, Chicago, Ill.

Foreign Agents:

London—Gorrings American News Agency, 9A Green St., Leicester Square, W. C. 2, England.
Paris—Messageries Dawson, 4 Rue Faubourg, Poissonniere, France.
Melbourne—McGill's Agency, 179 Elizabeth St., Australia.
Dunedin—James Johnston, Ltd., New Zealand.

RADIO-CRAFT is published monthly, on the first of the month preceding that of date; subscription price is \$2.50 per year in U. S. and Canada. (In foreign countries, \$3.00 a year to cover additional postage.) Entered at the post office at Springfield as second-class matter under the act of March 3, 1879.

Text and illustrations of this magazine are copyright and must not be reproduced without permission of the copyright owners.

Copyright 1938 Radcraft Publications, Inc.

MANY OPPORTUNITIES FOR THE COYNE TRAINED RADIO MAN



Are You Ready for a Better Job—More Pay?

Don't be an untrained man. Let me show you how to get your start in Radio — a fast growing, live money-making industry.

Prepare for jobs as Assembler, Inspector and Tester—Radio Sales or Service and Installation Work—Broadcasting Station Operator—Wireless Operator on a Ship or Airplane or Sound Work — HUNDREDS OF OPPORTUNITIES for a real future in radio!

12 Weeks of Shop Training

We don't teach by book study. We train you on a great outlay of Radio, Television and Sound equipment—on scores of modern Radio Receivers, actual Broadcasting equipment, Television apparatus and Sound Reproduction equipment, Code and Telegraph equipment, etc. You don't need advanced education or previous experience. We give you — RIGHT HERE IN THE COYNE SHOPS — the actual practice and experience you'll need for your start in this great field. And because we cut out all useless theory and only give that which is necessary you get a practical training in 12 weeks. Mail coupon for all facts about my school and training methods.

TELEVISION and PUBLIC ADDRESS

Television is sure to come as a commercial industry. Rapid progress is now being made in developing this new field. It will offer opportunities to the man who is trained in Radio. Here at Coyne you learn Television principles, and work on actual Television equipment. Public Address Systems offer opportunities to the Trained Radio Man. Here is a great new Radio field which is rapidly expanding. Prepare NOW for these wonderful opportunities! Learn Radio Sound Work at COYNE on actual Sound Reproduction equipment. Not a home study course.

SEND FOR DETAILS OF MY "PAY AFTER GRADUATION" PLAN

Mail the Coupon below and I'll tell you about my "Pay After Graduation" Plan which has enabled hundreds of others to get Coyne training with very little money. On this plan you can get your training first, then take 12 months to complete your small monthly tuition payments starting 5 months after you begin training. Not a home study course.

Mail the coupon for all details of this "Tuition Payment Plan."

PRACTICAL WORK at COYNE in Chicago

ACTUAL, PRACTICAL WORK. You build and service radio sets. You get training on real Broadcasting equipment. You construct Television Receiving Sets and actually transmit your own Television images over our Television equipment. You work on real Sound equipment. You learn Wireless Operating on Actual Code Practice apparatus. We don't waste time on useless theory. We give you the practical training you'll need for your start in Radio—in 12 short weeks. If you desire code, this requires additional time for which there is no extra charge.

Mail Coupon Today for All the Facts

H. C. LEWIS, Pres. RADIO DIVISION Founded 1899
Coyne Electrical School
500 S. Paulina St., Dept. 98-8H, Chicago, Ill.

ELECTRIC REFRIGERATION AIR CONDITIONING AUTOMOBILE ELECTRICAL WORK

Instruction now included at no extra cost. Here is your opportunity to learn these valuable allied lines without extra tuition charge.

PART TIME EMPLOYMENT TO HELP YOU "EARN WHILE LEARNING"

If you are short of money and need part time employment to help pay for your room and board while training, my Employment Department will help you get a part time job.



GET THE FACTS

Don't let lack of money prevent your sending in the Coupon. Mail the Coupon today and I Will send you the Big FREE Coyne Book full of FACTS.

H. C. LEWIS, Pres.
Radio Division, Coyne Electrical School
500 S. Paulina St., Dept. 98-8H, Chicago, Ill.

Dear Mr. Lewis:—Send me your Big Free Radio Book, and all details of your "Pay After Graduation" Plan including valuable instruction in Electric Refrigeration, Air Conditioning and Automobile Electrical Work.

Name.....
Address.....
City..... State.....

A New Policy!

FREE INSPECTION PLAN

You can buy any Gernsback Manual on Three Days' Approval

Perhaps you're new in Radio—or probably, in previous years you missed one of the Gernsback OFFICIAL RADIO SERVICE MANUALS. This is your opportunity to buy any edition you might need—get it in a way differently than ever before offered. Under a new policy—FREE INSPECTION PLAN—you can buy any Gernsback Manual on Three Days' Approval. There are thirteen Manuals and books from which to choose—every man in Radio should take advantage of this privilege.

Here Is How It's Done!

Order any GERNSBACK MANUAL illustrated and described on this page—the publishers will ship it to you immediately POSTPAID. When it reaches you, inspect its contents. If, after three days' inspection, you decide to keep the Manual, mail your remittance to the publishers. If the volume proves unsuitable, return it postpaid.

This plan is simple—there's no mystery or red tape—it gives you every opportunity to inspect the Manual of your selection. It costs you only a few cents return postage if you decide not to keep it.

Latest Volume 7 Manual Included

Volume 7 of the OFFICIAL RADIO SERVICE MANUAL—the edition which stamped the Radio industry this past year because it was published in a new way—in twelve monthly installments, is included under this new policy. This volume is now complete—twelve installments, totaling 1,800 pages, are bound in a hardcover binder and just packed with information you need today—and in the years to come. The coupon below gives you the privilege of inspecting this Manual also before you buy it.

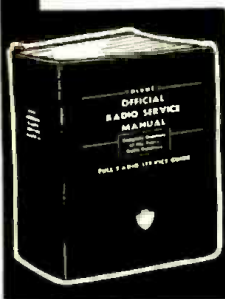

★ **VOLUME 7** ★
Newest of GERNSBACK MANUALS, contains schematic diagrams and service data on 1936-37-38 receivers. More up-to-date than any service guide published, 1,800 pages of finished, 1,800 pages of wiring diagrams of over 1,200 different manufactured sets. Over 3,000 different illustrations. Bound in hard, loose-leaf covers—mechanism permits pages to be removed and replaced. Size—9 x 12 inches.
PRICE \$10.00



★ **1936 MANUAL** ★
Contains 1,200 pages (over 2,500 illustrations) packed with service data of 1935-36-37 sets. Diagrams of over 1,500 receivers. Shows speaker connections, power transformer connections. Alignment procedure included. Operating voltages for over 80% of sets are recorded. Assembly diagrams show relationship of separate units to each other. Size—9 x 12 inches; hard cover, looseleaf binder.
PRICE \$7.00



★ **1935 MANUAL** ★
An authentic radio service guide of over 1,000 pages with more than 3,000 illustrations—contains schematic diagrams of 1934-35 receivers. Features many old sets never previously described, early all-wave and short-wave sets, auto-radios, midket and clikar-box receivers. Includes data on I.F. amplifiers, servicing instruments, tube information and FREE QUESTION AND ANSWER SERVICE. Size—9 x 12 inches; flexible, looseleaf covers.
PRICE \$7.00

★ **1935 AUTO-RADIO MANUAL** ★
OVER 240 PAGES
OVER 500 ILLUSTRATIONS
Looseleaf Binder—Flexible Covers
PRICE \$2.50



★ **1934 MANUAL** ★
Contains over 400 pages—over 2,000 illustrations. The schematic diagrams cover 1933-34 receivers. Features voltage readings, I.F. transformer values in superhets, valuable tube data and FREE QUESTION AND ANSWER SERVICE. A handy index makes it easy to find any information on service problems. Master index includes diagrams published in previous MANUALS. Size—9 x 12 inches; flexible, loose-leaf covers.
PRICE \$3.50



★ **1933 MANUAL** ★
This 700-page Manual, with over 2,000 illustrations, contains page after page of operating notes—schematics showing location of parts on chassis—values of I.F. peaks, resistors and condensers. A complete section on construction of various types of test equipment, plus money-making ideas for radio men. Includes auto-radio installation and servicing. Size—9 x 12 inches; flexible, loose-leaf covers.
PRICE \$5.00



★ **1932 MANUAL** ★
This Manual contains a full radio service guide of 1931-32 receivers. With over 1,000 pages and over 2,000 illustrations, it features a step-by-step analysis in servicing a receiver—chart showing operation of vacuum tubes—schematic diagrams with color coding indicated—commercial short-wave receivers and adapters and servicing public address equipment. Size—9 x 12 inches; flexible, looseleaf covers.
PRICE \$5.00

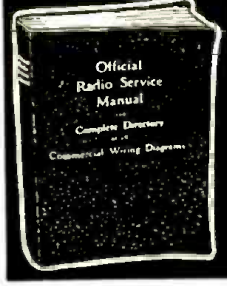

★ **1931 MANUAL** ★
The first of the famous GERNSBACK MANUALS—contains all available wiring diagrams of nearly every receiver manufactured since 1927, and many prior to the year. This particular edition contains 650 pages (including supplements) with over 1,500 important diagrams. Most valuable to radio men everywhere. **RADIO SERVICE COURSE** published in this edition. Size—9x12 inches; flexible, looseleaf covers.
PRICE \$4.50
including supplements.

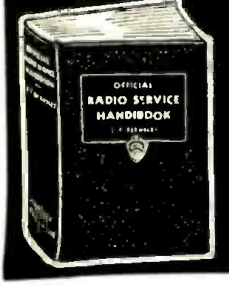

OFFICIAL RADIO SERVICE HANDBOOK
Here's the sensational book on servicing. Covers over 500 topics. Contains a special section of 250 pages of Operating Notes. The book covers: Circuit Theory and Analysis; Modern Servicing and Test Equipment; Practical Trouble Shooting; Specialized Receiver and Installation Data; Modernization and Conversion Data, etc. Over 1,000 pages—over 1,000 illustrations; hard covers. Size 9 x 9 inches.
PRICE \$4.00

● This Policy Includes —

- OFFICIAL REFRIGERATION SERVICE MANUAL (Volume 1) — \$5.00
- OFFICIAL REFRIGERATION SERVICE MANUAL (Volume 2) — \$5.00
- OFFICIAL AIR CONDITIONING SERVICE MANUAL — \$5.00

How To Get Any Manual You Need!

After you have definitely decided which Manual you want, fill in completely the coupon at the right. Clip it to your letterhead or paste on a penny post card and mail to the publishers. In a few days your Manual will reach you—Don't lose time—send coupon, TODAY, to

RADCRAFT PUBLICATIONS, Inc.
99 Hudson Street New York, N. Y.

RADCRAFT PUBLICATIONS, Inc.
99 Hudson Street, New York, N. Y. RC-1238

Please send me, POSTPAID, _____ for three _____ (Name of Manual or Book) days' examination on approval. In three days I will remit to you the full cost of the Manual or book selected, or return the volume to you postpaid.

Name _____

Address _____

City _____ State _____

Name of company or employer _____
(This offer is good only in continental United States.)



' TAKES THE RESISTANCE OUT OF RADIO '

THE RADIO TUBE AGE

By the Editor — HUGO GERNSBACK

WHAT the heart is to the human body, what the engine is to the automobile, the radio tube is to the radio receiver and transmitter.

As a vital, indeed the most vital, part of radio communication, the radio tube art and technique has gone ahead by leaps and bounds, so that today's radio tubes are a far cry from de Forest's Audion of the vintage of 1908, only 30 short years ago. What then can be reasonably expected of the radio tube 30 years hence? And 100 years hence?

All radio tubes, whether for receiving or transmission purposes, have been increased in efficiency thousands of times over the first tubes of 30 years ago. Receiving tubes have become marvelously sensitive so that today it is quite possible—indeed it is done every day—that a single-tube radio receiver is used to bring in signals of radio stations from the Antipodes, 14,000 miles away.

Yet radio tubes increase in efficiency, in sensitiveness and in versatility from month to month, and every six months witnesses a tremendous improvement over what went on in the art before. There are today so many hundreds of different types of tubes, for hundreds of different purposes, that it becomes difficult, even for the expert, to keep track of them; yet each and every new development is the forerunner of other new developments soon to follow.

Tubes for receivers are not only constantly shrinking in size, but many of the modern tubes embody within a single envelope the elements of a number of tubes that were necessary as separate tubes only a few years ago. It is quite conceivable, therefore, that sooner or later from one to three of these multiple tubes will do all the work that an eight- or ten-tube radio receiver does today. Indeed it is even possible, right now, to make a single multiple tube that would replace ten radio tubes of only five years ago. Only economic reasons have so far prevented the large-scale manufacture of such tubes.

Similar advances have been made on the transmitting tubes, particularly in the type of high-power tubes for broadcasting and other purposes.

While the present radio tubes are dependent upon a heater or cathode to produce the necessary electronic emission within the tube, scientists for years have known that the ultimate in tube design will, no doubt, be heaterless tubes which do not require either a hot filament or a glowing member. Today, despite the fact that radio tubes have increased in efficiency tremendously, it is also true that from the standpoint of electronic emission efficiency they are still wasteful. In order to operate our tubes today, the heaters generate a great deal more electronic emission than is actually needed. On top of this, as the life of the tube wears on, the tube becomes less and less efficient because of the destructive effect of the internal electronic bombardment, particularly at the points where no electronic emission is needed. This, in time, lowers

the vacuum of the tube and, by the deposit of metal particles where they are not wanted, the tube continually decreases in efficiency. After a certain life—even though the filament is not burned out and the cathode is still in good working order—the tube nevertheless must be replaced.

The heaterless tube, on the other hand, will probably be operated as a "potential" device, the electronic emissions being provided by the action of the electric current itself without any noticeable heat effect.

It remains only to find the right materials which, at cold or normal room temperatures, will emit a powerful stream of electrons. There are of course some such materials known today as for instance, all of the radio-active substances, including radium. These are all immensely powerful electron emitters but none of them have been found suitable in radio tube practice.

Sooner or later either the right material will be found or, what is also quite possible, some new heaterless tube construction will be evolved which will give us the necessary electronic emission, without which so far the radio tubes have not been able to operate.

Why do scientists pay so much attention to the heaterless radio tube? The reason is very simple. First, it will make the radio set practically independent of the power which we require today; for home use, radio sets will probably always be plugged into your light outlet but, when we have heaterless tubes, the cost of operation, due to the lower current consumption, will drop considerably. But for portable radio sets, particularly the pocket radio set of the future, or the wrist-watch radio set, so much publicized, will require only a very small high-tension pocket battery, small enough to fit your vest pocket. This is tremendously important, particularly for war purposes, when mobility is paramount and where the reduction of weight is the one important factor that, so far, has kept every radio set out of the knapsacks of soldiers. With the heaterless set it will be possible to have a very sensitive, as well as powerful, loud-speaker set, weighing less than half a pound, high-tension battery and all. While, of course, it is possible today to construct such a set, using miniature "A" batteries which do not weigh a great deal, it is also true that they do not last very long; even though the filament consumption of some of our modern radio tubes is exceedingly low. But "A" batteries at best are always more or less of a bother and for that reason military authorities, explorers, aviators, etc., have always asked for efficient radio sets requiring no "A" batteries at all.

This by no means closes the subject. There are other important considerations for the radio tubes of the future.

My advice to radio students is that they should watch, more than anything else, the radio tube developments of today, because they provide the key to the design of improved radio and television sets which are as yet unconceived.



ROSS A. HULL—1902-1938

OBITUARIES

It is with a sad heart that *Radio-Craft* here amplifies the last-minute notice which appeared in last month's issue concerning the untimely death of Ross A. Hull, late editor of *QST* magazine, official organ of the American Radio Relay League.

Ross was an expert radio technician, and his death must not be in vain; let not only every member of the A.R.R.L., but every radio experimenter, every radio technician, every radio Serviceman, everywhere, keep before him in memoriam the image of a young man whose burned hands and face and stilled heart, bore mute testimony to the lethal possibilities of high-voltage radio circuits.

Excusing himself to his dinner guests at his home near Hartford, Conn., amateur experimenter Hull went to his radio room, tuned in RCA/N.B.C.'s television sound, then prepared to adjust the sight portion of the receiver for the program which was being transmitted from the Empire State Building in New York City. Investigators believe that a shock was received from unprotected wiring which was sufficient to throw him into a haywire test set-up on the floor where probably an ampere at very high voltage was carried through his head by headphones later found burned to a crisp. *Radio-Craft* has told how television has witnessed two suicides; and now records how it has claimed its first life.

Remember, even 110 volts is sufficient to pass a fatal amount of current through a person, under certain conditions. How much more dangerous, then, must be the circuits of television receivers, diathermy equipment, and high-power amateur transmitters, which require thousands of volts in the plate circuits. True, the ordinary types of television tubes require but a few *microamperes* to operate them, but the filter condensers charge to a value capable of delivering an instantaneous output of several hundred kilowatts/second, and

THE RADIO MONTH

high-voltage secondaries frequently have good regulation and hence are capable of delivering much more current than the cathode-ray tube requires.

As *Time* magazine pointed out last month in commenting on Mr. Hull's death, it is no longer sufficient to hang up a sign reading "DANGER—HIGH VOLTAGE!" What is needed are protective measures RIGHT AT THE APPARATUS which will make it impossible to touch any part of the apparatus or its wiring while the current is on; or off, unless high-capacity condensers are first discharged.

Armstrong Perry, a radio writer well known to old-timers, passed away last July, *Radio-Craft* learned last month, at his home in Westport, Conn. A heart attack terminated the career of the young man who for the last 5 years had been director of the service bureau of the National Committee on Education by Radio, at Washington, D. C.

A shark caused the death of William Baker, radio telegrapher aboard the British escort vessel *Folkstone*, last month. The shark bit off Baker's leg while he was swimming alongside the ship as it lay at anchor in the outer harbor of Tsingtao, China.

Harry R. Chetham, 48, chief radio operator of the Police and Fire Departments of Somerville, Mass., died last month in Chelsea Naval Hospital.

For installing radio equipment on the leper-colony island of Penikese, in Buzzard's Bay, 25 years ago, the Veteran

Wireless Operators' Assoc. of New York had given him a gold tablet. Early coherer-and-sparkcoil equipment he had built years ago is in the National Smithsonian Institution at Washington, D. C. Chetham's work during the World War in intercepting a spy's flashlight signals is now history; as is his work in intercepting several SOS signals, including those of the sinking *Titanic*.

THE STORM

THE freak storm which last month wreaked havoc on the Eastern seaboard cast radio, once again, in the hero's role.

Amateurs in all the states affected, did Trojan work, advising of local emergencies and helping relief organizations. All the amateur radio operators in the Long Island Army network, as one example, were operating under direction of the U. S. Army; most of the work, except for the transmissions of certain key stations, was in listening for SOS and other emergency signals from the affected areas, indiscriminate transmissions into the affected areas not being permitted in view of the possibility of missing a weak emergency signal from an isolated district. The fate of many small towns was not learned until radio bridged the gap between them and civilization.

When the storm caused a breakdown in the interstate police teletype system between New York and Connecticut, the Greenwich (Ct.) Police Dept. set up short-wave radio communication with

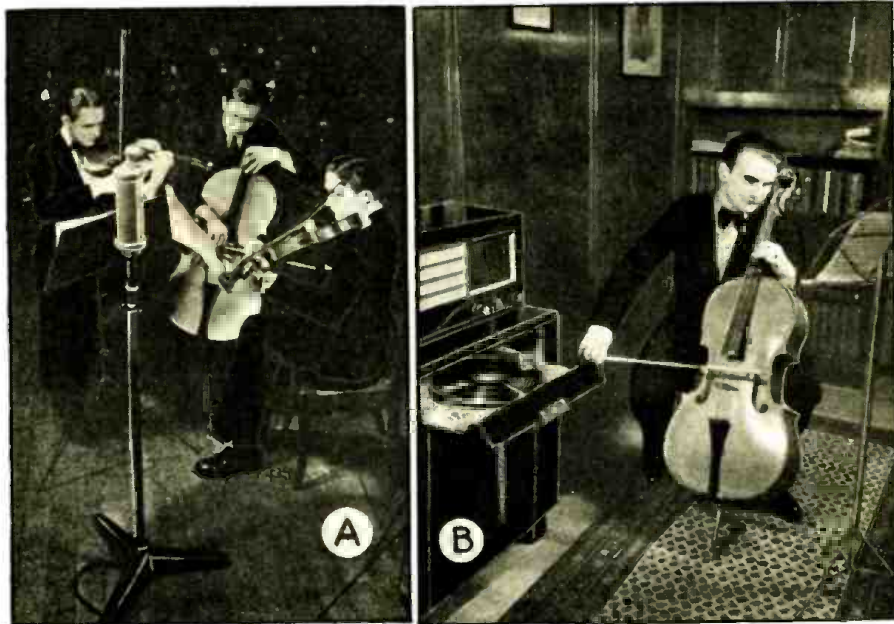

PHANTOM PLAYERS

Radio Press Service last month reported how Telefunken (Germany) has produced a library of over 300 titles, including such composers as Havdn, Bach, Tchaikowsky, Mozart, all with missing musical elements! Purpose of this amazing group of phono recordings is to enable a singer or musician to fill-in, with his own voice or instrumentation, in the place of the missing artist. Above, a 3-piece orchestra is shown recording; played back, the purchaser (right) fills-in as the 4th.

IN REVIEW

the N.Y.C. Police Dept. Requests from friends and relatives for information about people in New England's storm area, received by the N. Y. police and forwarded to Greenwich were passed on to the police at Hartford, Conn., where the American Radio Relay League had a headquarters set-up which maintained contact with amateurs throughout New England.

Keene, New Hampshire, a city crippled with streets under water, gas mains broken, electric light lines down, and telephone communication paralyzed, depended upon amateur radio operators to plead its cause for relief aid.

In New York, broadcast station WOR had its power supply lines from Rahway, N. J., snapped by falling trees; a minute later emergency lines from Elizabeth, N. J., were switched in. Station WEAJ went off the air for a time, due to failure of the regular power lines from the Long Island power company, until emergency lines from the same company could be set up (several hours later). Station WABC, key of C.B.S., went off the air for about 45 minutes due to power failure at its Wayne, N. J., transmitter; it came back on the air first with power from WHN, then WNYC, and finally, under its own power about 5 hours later. Station WNYC was temporarily off the air; and efforts to use the city's auxiliary transmitter at Brooklyn Technical High School proved futile due to damage by the storm to one of its towers. Station WMAC was silenced when 6 feet of

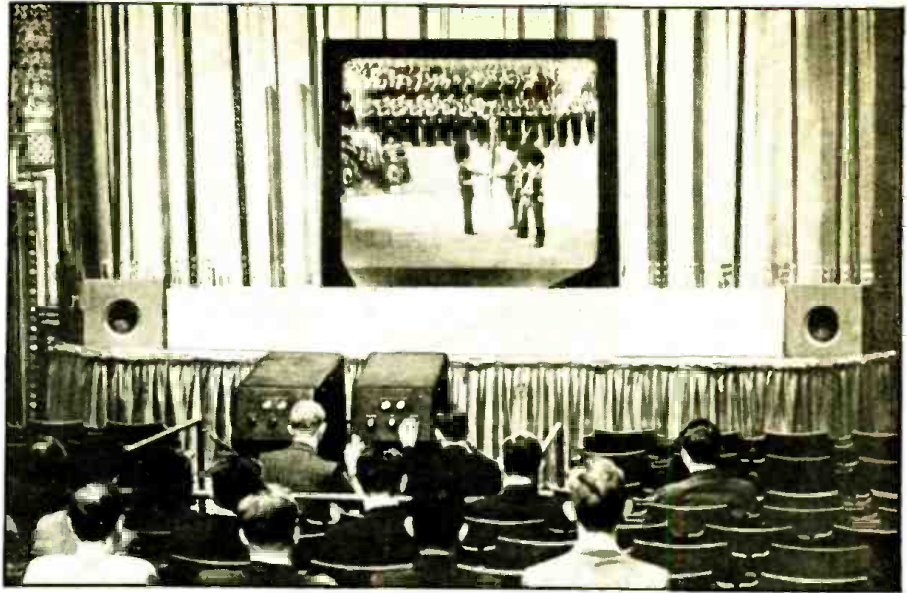

THEATRE TELEVISION

Last month, Practical and Amateur Wireless (London) reported the B.B.C. television program, "Trooping the Colour"; here you see how it was received in the "Tatler" News Theatre in London, using a Baird projector to secure the 8x6 ft. image. Technical details, supplied to Radio-Craft by courtesy of Baird Television, Ltd., may be of interest to readers.

The set-up as now demonstrated is composed of (a) a Projector Unit (b) a Receiver and Power Supply Rack and (c) an Extra-High-Voltage Rectifier Unit. A voltage-doubling circuit delivers 300 microamps. at 30,000 volts to the cathode-ray projection tube. Total power consumption is 2 kw. Fidelity of course was that of B.B.C.'s transmission—441 lines. The accompanying sound system delivered 15 watts, flat within ± 4 db. from 30 to 20,000 cycles, to the speakers.

water flooded the transmitter at Flushing, L. I. Emergency pumps at WJZ's Bound Brook, N. J., transmitter helped keep the basement containing the generators from flooding; local firemen were requested to standby with additional pumps to lend a hand if necessary. Trans-Atlantic communication and broadcast service was crippled when huge Marconi-type antennas on Long Island, and telephone facilities to New York City, were wrecked.

A cooperative gesture which should not go unrecorded was that of WOR-Mutual in placing its auxiliary 5,000-watt Carteret (N. J.) transmitter, master control and wire lines at the disposal of N.B.C.'s disabled WEAJ at Bellmore, L. I., should this station have found it impossible to make other arrangements. To accomplish this necessitated stringing a *jury antenna* from WOR's towers to permit simultaneous transmission with WEAJ. While the wind and rain whipped over the Jersey flats an emergency call went out from WOR for steeplejacks who would be willing to mount the swinging towers, and in the teeth of the gale, string the second antenna; in 10 minutes, phone calls from 100 willing steeplejacks were received!

At the height of the storm, and for days after, broadcast listeners were kept informed of conditions throughout the area laid waste by the tropical hurricane and the tidal waves that swept the Atlantic coast in its wake.

For instance, in a half-hour microphone roundup, WJZ carried eyewitness accounts of conditions in Providence, R. I., a city marooned "by Rhode Island's worst disaster" (to quote the *N. Y. Times*), which State had reported 400 persons missing and property damage running into many millions (as was the case in practically all the states affected); Boston included in its highlights the statement that slate roofing and shingles flew like confetti, and in Springfield, Mass., home of Phelps Publishing Company, which prints *Radio-Craft*, isolation of the city was complete.

(Continued on page 360)



AVENUE BRANLY

The question of whether to give the name of "Avenue Branly" to a thoroughfare in Paris Champs-de-Mars which so far hadn't been given a name, connecting the Avenue Octave-Greard and the Avenue Silvestre-de-Sacy, waited 3 years for the answer. Last month, French Information Service reported to Radio-Craft in this connection as follows: "The initiative was taken by a committee of private citizens. This committee is not satisfied because the thoroughfare now known as the 'Avenue Branly' is just a passageway through the Champ-de-Mars, carries very little traffic, and has no building of any sort. The committee would have preferred to have the name of Branly given to an important thoroughfare. "But the Municipal Council has decided to the contrary because it felt that it was absolutely justified in honoring one of the inventors of the wireless by giving his name to a thoroughfare which is at the foot of the Eiffel Tower, the first French wireless station of any importance. Furthermore, this thoroughfare is close to the statue of General Ferrie, the founder of military wireless, which has been erected in the Champ-de-Mars near the entrance of the wireless station of Eiffel Tower. It should not be forgotten either that, by giving the name of Edouard Branly to one of its thoroughfares, while he is still living, the City of Paris has made an exception to the general rule and has therefore conferred a special honor upon this great scientist." The photos of this Avenue reproduced above were made special for Radio-Craft by the Paris Office.

TRAFFIC LIGHTS IN YOUR CAR



The 1-tube low-power ultra-highfrequency transmitter mounts on top of existing traffic posts receiving its power therefrom. Its integral Hertzian dipole antenna radiates directional polarized radio waves of less than 2 meters in length.

Through the courtesy of the editors of March of Time, RADIO-CRAFT describes the new traffic control system. STOP, CAUTION your car regardless of snow, rain, etc., and in step with traffic lights

ALBERT E.

A NEW radio traffic control system, now advancing from its experimental stages, promises to revolutionize traffic control by using radio beams (see illustration below) to supplement visual signals in smoothing out and coordinating traffic flows on highways and city streets. An artist's conception of the new radio traffic lights in use in a car is shown on the cover of this issue of *Radio-Craft*.

The system, the invention of William S. Halstead, New York communications engineer, is shown for the first time in exclusive motion pictures by the MARCH OF TIME'S new episode entitled "Man at

COVER FEATURE

the Wheel." This timely film deals with a dramatization of U.S. traffic problems as they now exist and shows what is being done to solve them through a program of engineering, education and enforcement.

MODUS OPERANDI

The experimental radio traffic control equipment as shown in the MARCH OF TIME in its simplest form consists of a small, low-power, ultra-highfrequency transmitter which acts supplementary to the conventional red, amber and green visual traffic signals, and an ultra-highfrequency receiver which is installed on cars or other vehicles to selectively control the operation of miniature signal lights disposed on

the instrument panel. An audible alarm such as a small chime is also connected to the radio receiver to provide audible indication of change in external signals. Directional ultra-highfrequency wave energy is directed along a particular lane or track to actuate receivers in accordance with the signaling characteristic of the correlated signal light. Modulation of the wave by A.F. control signals or carrier keying by timed impulses is used to effect remote control of the signaling devices within an approaching vehicle. Operation may be on a wavelength below 2 meters.

TRANSMITTER

The transmitter is a small, self-contained unit which, as shown by photo at upper-left, is designed to be mounted on the top of existing traffic light housings.

Power to operate the transmitter and effect emission of a particular control signal related with each light is obtained from existing power circuits within the traffic light housing.

A single tube is employed as an ultra-high-frequency oscillator. Frequency control is effected by the use of tubular resonators and by the incorporation of a Hertzian dipole radiator as an inherent part of the transmitter assembly in fixed relationship to the oscillating circuit.

RECEIVER

Receivers are of the aperiodic or untuned type requiring no manual adjustment in order to receive ultra-highfrequency wave energy on several different wavelengths within several centimeters of each other.

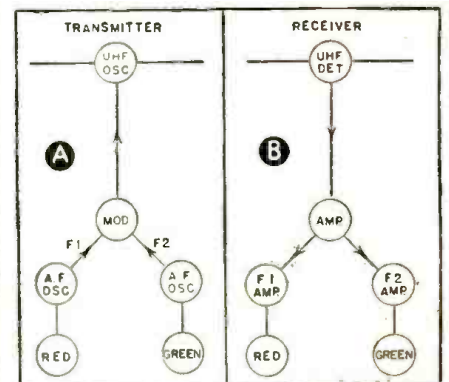
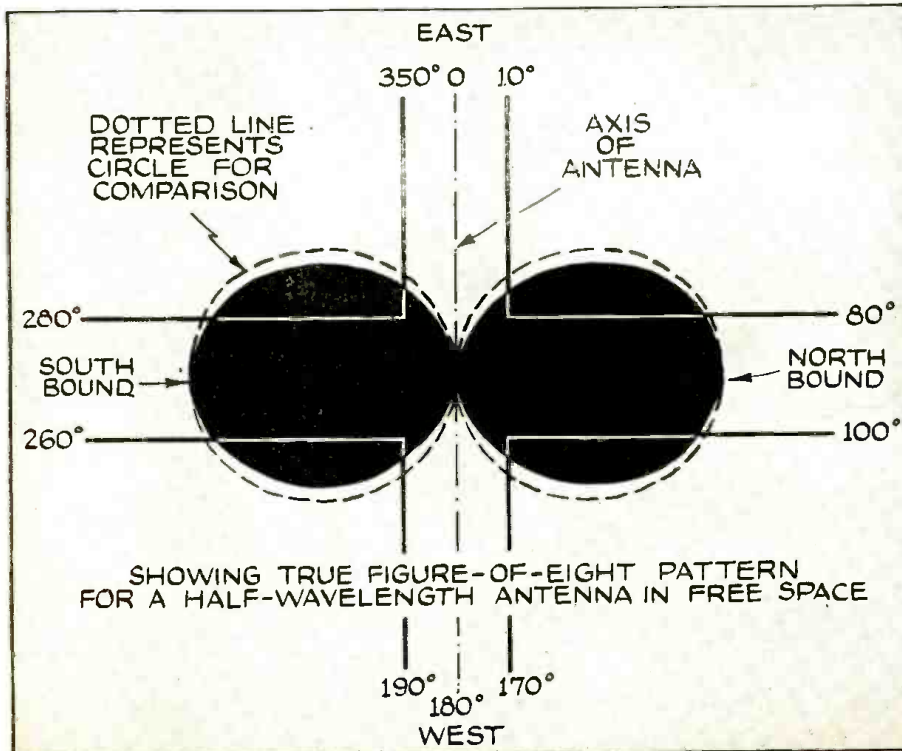

↑ Simplified block diagrams of (A) the transmitter and (B) the receiver. F1 and F2 represent two separate audio-frequency tones or impulses which modulate the oscillator of the transmitter. The amber caution light is not shown here, but if used, would inject a third audio frequency or impulse. In the receiver, selective devices separate the different audio tones.

← The "Figure 8" pattern and direction of radiation of the Hertzian half-wave dipole transmitting antenna. When applied to traffic control, the dipole is placed with its axis perpendicular to the lane of traffic in which radio control is to be effected. A second dipole, disposed at right-angles to the first, then controls traffic in the intersecting lanes. A pattern of the radiation fields of both dipoles would represent something like a 4-leaf clover.

—BY RADIO!

CRAFT is able to present to its readers the first generation and GO signals automatically flash inside on the street, by means of directional radio signals.

SINDLINGER

A horizontal dipole receiving antenna installed on the front of a car is employed to pick-up horizontally polarized space waves when within a given signaling zone. Pick-up from the rear is precluded by the use of the body of the vehicle as a wave shield.

Signal-discriminating (selecting) devices which are attached to the receiver may be of several types depending on the signaling characteristic employed. If audio-frequency control tones are used, small filters built into the audio amplifier serve to separate the tones and selectively actuate particular relays, thus energizing either a red or green light on the instrument panel. If impulse keying of the R.F. carrier is employed, a standard type of impulse selector such as is used in remote control of broadcast receivers will suffice to select a given light.

Practically any degree of directivity can be given to the emitted wave by the use of reflectors or wave guides, thereby adapting the radio system to any local traffic plan. By the use of single-wire conductors, or by utilization of the rails of parallel tracks in railroad signaling, the ultra-high-frequency wave energy can be confined to extremely narrow lanes or guided around corners.

LANES AND INTERSECTIONS

In future highway radio traffic control systems, as shown by MARCH OF TIME, directivity may be given to the emitted wave by the use of the Hertzian half-wave dipole. Thus the "Figure 8" horizontal radiation pattern is employed to concentrate radiation in 2 major directions along a lane of traffic. A second dipole disposed at right-angles to the first will then control traffic in the intersecting lane.

Directivity is further heightened by use of the relationship which exists between mutually parallel and perpendicular dipoles in space. When the transmitting dipole is parallel to that of the receiver a signal of maximum intensity is ob-

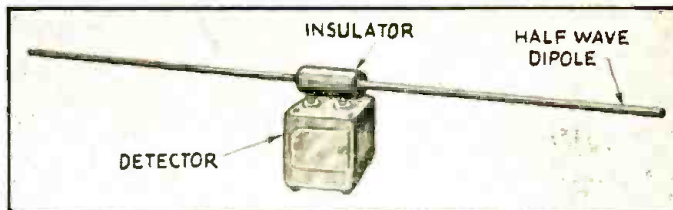

The miniature ultra-high-frequency receiver with its integral horizontal dipole antenna. The receivers are of the aperiodic or untuned type, requiring no manual adjustment for receiving ultra-high-frequency wave energy on different wavelengths within several centimeters of each other.



These are the red, amber and green signals which mount on the left windshield post at the eye level of the driver. Selective devices attached to the receiver pick off the audio frequency control tones which individually actuate these Stop, Caution and Go signals.

tained. When the 2 dipoles are at right-angles to each other the signal is at a minimum value (see street "Figure 8" pattern).

Thus in the radio traffic control adaptation in which vehicles on intersecting streets are involved, cars proceeding North and South will receive with maximum intensity only signals from the dipole which is designed for control in the North-South lane.

ADVANTAGES

Advantages of the radio traffic control method include (a) extremely high efficiency under all weather conditions; (b) low operating cost (approximately 1/100 of that for power used by the visible light system); and, (c) ease of adaptation for carrying aural police department emergency warnings, detour instructions, and all types of highway information directly to drivers of cars on specific routes via connections with telephone circuits.

First use of the traffic control system, which is now in the field test stage, is expected to be on railroads to supplement
(Continued on page 368)

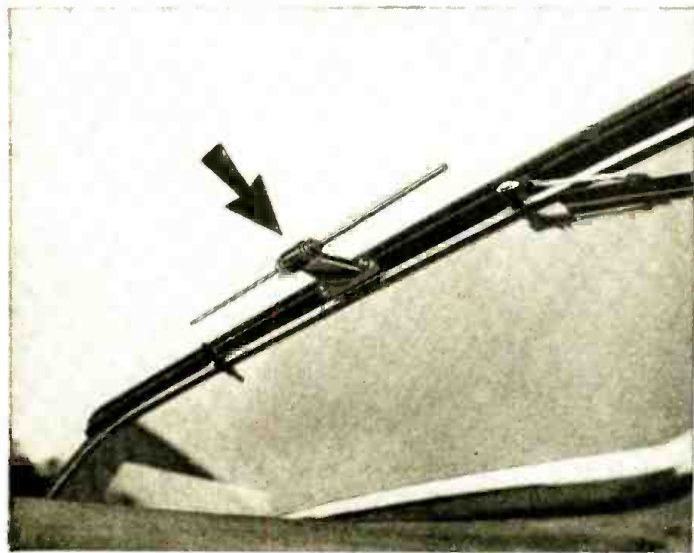

A horizontal dipole receiving antenna, installed on front of a car, picks up the horizontally polarized radio waves of the transmitter when within a given signaling zone. Pick-up from the rear is precluded by the use of the body of the vehicle as a wave shield.

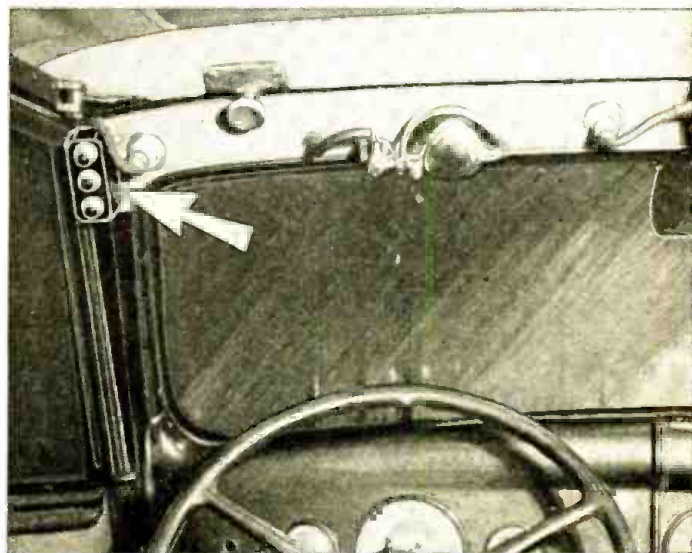

After experimenting with several different positions in the car it was found that greatest visibility and convenience to the driver were obtained when the Stop, Caution and Go signals were attached to the left windshield post of the car. Leads connect the signals to control equipment under this instrument panel.

NEW TUBES

Last month it was 15 new tubes . . . this month you; plus a batch of 8 new ballast "tubes." new "single-ended" construction, which

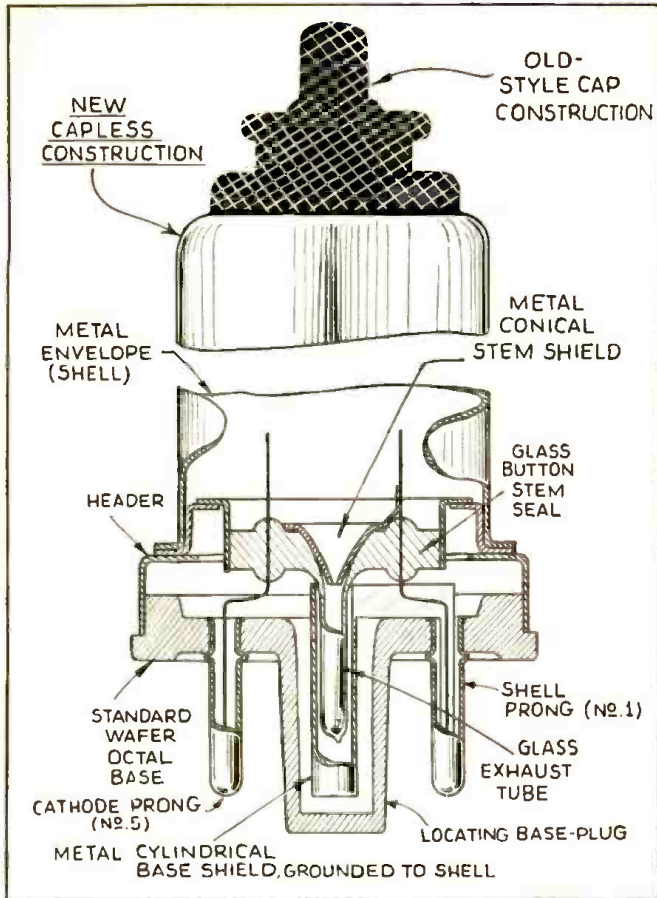

Fig. A

SERVICEMEN, and in fact technicians in every branch of radio (which we divide into the 3 major groups of Radio, Electronics and Public Address), seldom realize the diversity in characteristics and applications of new tubes. (Note the listing on pg. 331 of 22 new tubes.)

For this reason *Radio-Craft* has gone a step beyond its usual policy of presenting periodical reviews of new tube developments and coincident with this issue has instituted the annual feature of a Special Radio Tubes Number. Tubes which will have particular significance to radio Servicemen, and to technicians in the fields of Radio, Electronics and Public Address, during the early part of 1939 are here described.

In this connection *Radio-Craft* is indeed proud to here present one of the first published descriptions of a technical development which scraps all the preconceived opinions that a cap electrode on the top of a tube is essential for best results. The new "single-ended" construction, just introduced by RCA Manufacturing Co., Inc., transfers the control-grid terminal from the top of the tube to one of its base prongs.

This is the opening gun in electronic developments for 1939! See Fig. A.

SINGLE-ENDED (CAPLESS) TUBES

A high- μ triode, a triple-grid detector, a triple-grid super-control amplifier, and a capless diode—high- μ triode, constitute the first types in the new line of *single-ended* tubes in which all electrodes including the control-grid terminate at the base pin, by employing a radically new construction with inter-lead shielding.

As a result of this new construction (made possible by modern methods of tube manufacturing) the R.F. amplifier pentode 6SJ7 and 6SK7 not only have the same grid-plate capacity as the similar capped type but also have lower values of input and output capacity; and similarly, the A.F. types 6SF5 and 6SQ7 offer the same mechanical advantages as the R.F. amplifier.

These tubes may be mounted in either a vertical or horizontal position. There are no restrictions. In the illustrations of the terminal connections and tube symbols, the new metal shield which connects internally to shell terminal S (1) has been indicated by *Radio-Craft* as a chassis-symbol.

6SF5

The 6SF5 is a new metal high- μ triode featuring single-ended construction with interlead shielding between grid and heater within the base. The shielding reduces the hum voltage picked up by the grid lead from the heater leads, and permits operation with a satisfactory hum level. The electrical characteristics of the 6SF5 are similar to those of type 6F5.

From a circuit standpoint, the single-ended construction offers distinct advantages in comparison with corresponding types previously available, as follows: (1) elimination of loose or broken grid leads, (2) wiring can be completed below the set panel, (3) neater appearance of the chassis, (4) lowered cost, and (5) simplification of tube renewal.

The 6SF5 is recommended for use in resistance-coupled circuits. Operating conditions are the same as those for type 6F5. Characteristics data are given in Table I; tube terminals are shown in Fig. 1 (pg. 335).

Data supplied by: RCA Mfg. Co., Inc.—RCA Radiotron Division.



Fig. B

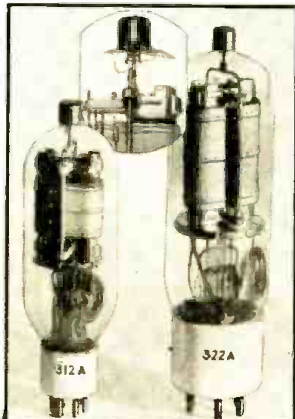

Fig. C

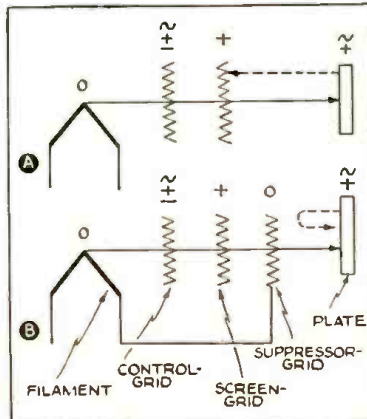

Fig. 5

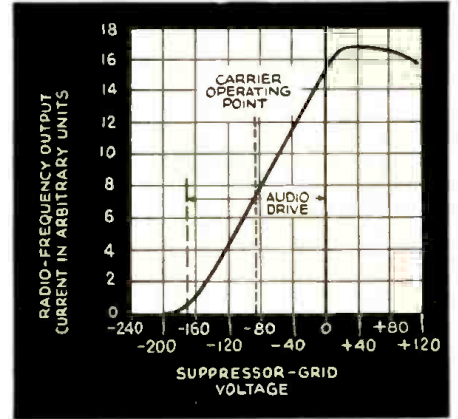

Fig. 6

FOR 1939

it's 22 tubes, we describe for Of special importance is the eliminates the grid-cap.

R. D. WASHBURNE

6SJ7

The 6SJ7 is a new metal R.F. amplifier pentode featuring single-ended construction with interlead shielding. As a result of modern methods of tube manufacture, this new type not only has the same grid-plate capacitance as similar capped types, but also has lower values of input and output capacitance, and higher transconductance.

From a circuit standpoint, the single-ended construction offers distinct advantages in comparison with types previously available, as follows: (1) elimination of loose or broken grid leads, (2) wiring can be completed below the set panel, (3) neater appearance of the chassis, (4) more stable amplifier operation, (5) greater uniformity of gain in amplifiers, (6) higher gain per stage, (7) lowered cost, and (8) simplification of tube renewal.

The 6SJ7 has a sharp cut-off characteristic. This tube has a small wafer octal 8-pinbase which fits the standard octal socket. Tentative characteristics and ratings are given in Table II. Tube terminal connections and symbols are shown in Fig. 2 (pg. 335).

Data supplied by: RCA Mfg. Co., Inc.—RCA Radiotron Division.

6SK7

The 6SK7 is a new metal R.F. amplifier pentode featuring single-ended construction with interlead shielding. As a result of modern methods of tube manufacture, this new type not only has the same grid-plate capacitance as similar capped types, but also has lower values of input and output capacitance, and higher transconductance.

From a circuit standpoint, the single-ended construction offers distinct advantages in comparison with types previ-

ously available, as follows: (1) elimination of loose or broken grid leads, (2) wiring can be completed below the set panel, (3) neater appearance of the chassis, (4) more stable amplifier operation, (5) greater uniformity of gain in amplifiers, (6) higher gain per stage, (7) lowered cost, and (8) simplification of tube renewal.

The 6SK7 has a remote cut-off characteristic. This tube has a small wafer octal 8-pinbase which fits the standard octal socket. Tentative characteristics and ratings are given in Table III. Tube terminal connections and symbols are shown in Fig. 2.

Data supplied by: RCA Mfg. Co., Inc.—RCA Radiotron Division.

6SQ7

The 6SQ7 is a new metal duplex-diode high-mu triode featuring single-ended construction with interlead shielding between grid and heater within the base. The shielding reduces the hum voltage picked up by the grid lead from the heater leads, and permits operation with a satisfactory hum level. The electrical characteristics of the 6SQ7 are similar to those of type 75.

From a circuit standpoint, the single-ended construction offers distinct advantages in comparison with corresponding types previously available as follows: (1) elimination of loose or broken grid leads, (2) wiring can be completed below the set panel, (3) neater appearance of the chassis, (4) lowered cost, and (5) simplification of tube renewal.

The 2 diode units are placed around a cathode, the sleeve of which is common to the triode unit. Each diode has its own base pin. Diode biasing of the triode unit is not suitable.

The application and operating conditions for the 6SQ7 are the same as those for the type 75. Tentative characteristics and ratings are given in Table IV. Tube terminal connections and symbols are shown in Fig. 3.

Data supplied by: RCA Mfg. Co., Inc.—RCA Radiotron Division.

TRANSMITTER TUBES

813

RCA 813 is a new beam power transmitting tube designed according to principles involving the use of directed electron beams of extremely high power sensitivity with a typical power output

22 NEW TUBES FOR 1939

- 6SF5—Capless High-Mu Triode
 - 6SJ7—Capless Triple-Grid Detector
 - 6SK7—Capless Triple-Grid Super-Control Amplifier
 - 6SQ7—Capless Diode—High-Mu Triode
 - 813—Beam Power Transmitter
 - 312A—Suppressor-Grid Modulator (low power)
 - 322A—Suppressor-Grid Modulator (high power)
 - 2109—Electromagnetic-Deflection Videotron (9-in. C.-R. television tube, with medium-persistence screen)
 - 2112—Electromagnetic-Deflection Videotron (12-in. C.-R. television tube)
 - 905—Electrostatic-Deflection, 3-in. C.-R. Television Type
 - 6AE5G—Triode Amplifier (for dynamic-coupled amplifiers)
 - 25AC5G—High-Mu Triode Power Amplifier (for dynamic-coupled amplifiers)
 - RK62—Gas-Triode Detector-Thyratron
 - RX884—Gas-Triode Hot-Cathode Control-Grid Type (6.3 V.)
 - RX885—Gas-Triode Hot-Cathode Control-Grid Type (2.5 V.)
 - 2A4G—Hot-Cathode, Argon-Filled, Single-Grid Thyratron
 - 313C—Cold-Cathode, Double-Gap, Gas-Filled Relay, Rectifier, or Voltage Regulator
 - 338A—3-Element, Argon-Filled Thyratron (with indirectly-heated cathode)
 - HY113—"Peanut"-size, A.F. Amplifier Triode (1.4 V. filament; 17.5 milliwatts output)
 - HY115—"Peanut"-size, A.F. Amplifier Pentode (1.4 V. filament; 5.5 milliwatts output)
 - HY125—"Peanut"-size, A.F. Amplifier Pentode (1.4 V. filament; 11.5 milliwatts output)
 - WL651—Metal-Shell Ignitron (for welding services)
- 8 GLASS BALLAST (RESISTOR) TUBES
- | | | | |
|--------|--------|--------|--------|
| K49AG | BL49DG | BM55BG | L36DJG |
| BK42CG | BM42BG | L36DG | L49BJG |

of 260 W. for class C telegraph service. See Fig. B.

The 813 has a new form of flare stem which has made possible reduced overall length, short internal leads, low lead inductance, and, consequently, improved high-frequency performance.

Full power output can be obtained with very little driving power and with a reduced number of driver stages. Neutralization is unnecessary in adequately shielded circuits. The 813 makes an excellent power amplifier for the

(Continued on following page)

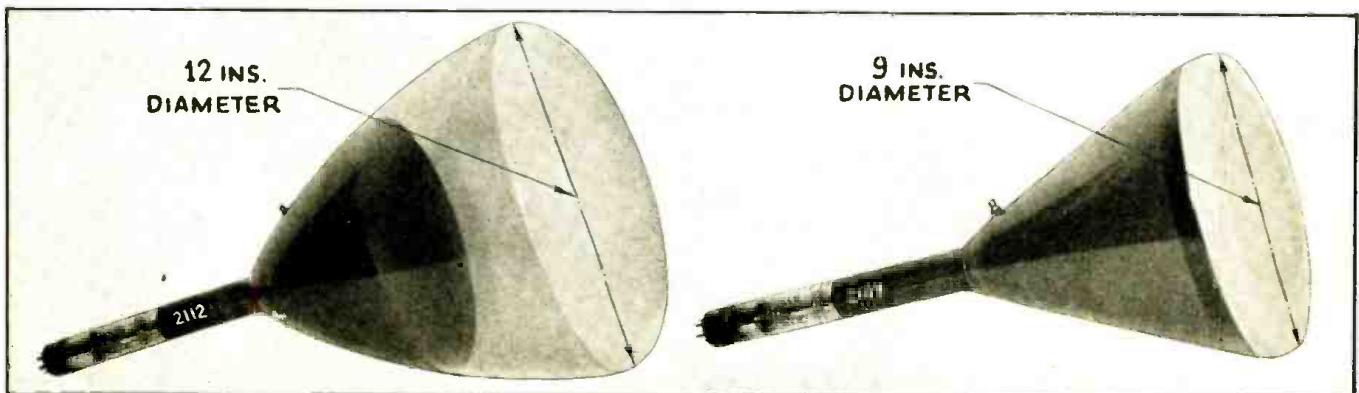

Fig. D

NEW TUBES



Fig. E

(Continued from preceding page)

final stage of high-power amateur transmitters where quick band change without neutralizing adjustments is desirable. It is also an excellent high-power frequency multiplier and is capable of giving high harmonic output with unusually high efficiency. The reduced overall length of the tube provides for short internal leads and minimizes lead inductance. As a result of its construction, the 813 can be operated at maximum ratings at frequencies as high as 30 mc. and at reduced ratings as high as 120 mc.

The base of the 813 fits a special 7-contact transmitting socket which should be mounted to hold the tube in a vertical position with its base either up or down. If it is necessary to place the tube in a horizontal position, the filament-base pins should be placed one vertically above the other so that the plate will be in a vertical plane (on edge). Free circulation of air around the tube should be provided. Connections must be made so that the wires will not be close to or touch the bulb.

The screen voltage should preferably be obtained from a separate source or from a potentiometer; when it is obtained from the plate supply through a series resistor, it is important that the high-voltage supply switch be opened before the filament circuit is opened and before the R.F. excitation is removed (otherwise, full supply voltage will be placed on the screen).

A protective device, such as a high-voltage fuse, should be used to protect both the screen and plate against overloads. Shielding and isolation of the output and the output circuits are necessary for stable operation.

The plate of the 813 shows no color at the maximum plate-dissipation rating for each class of service.

The rated plate voltage of this tube is high enough to be dangerous to the user. Care should be taken during the adjustment of circuits, especially when exposed circuit parts are at high D.C. plate potential.

Tentative characteristics and ratings are given in Table V. Tube terminal connections and symbols are shown in Fig. 4. The 813 employs a T-20 bulb.

Data supplied by: RCA Mfg. Co., Inc.—RCA Radiotron Division.

312A

Until recently there have been 3 major types of vacuum-tube modulation, which take their names from the tube element to which the voice-frequency voltage is applied. They are: (control-) grid modulation, plate modulation, and plate-and-screen (-grid) modulation.

A 4th form of modulation which is more nearly ideal, takes advantage of the dependence of the output power on the potential of the *suppressor-grid* in pentodes.

In a screen-grid tube that has no suppressor-grid, distortion and a loss in efficiency occur whenever the plate voltage swings too low. The set-up of such a tube is indicated in Fig. 5A (pg. 330). The filament is considered to be at zero, or reference, potential, and the screen-grid, which is at a constant positive potential, accelerates the electrons toward the plate. The potential of the control-grid varies with the carrier frequency, and may be positive during part of the cycle. Electrons accelerated by the screen-grid pass through it and strike the plate, giving rise to secondary electrons. The potential of the plate, although biased more highly positive than the screen-grid, varies with the signal, and if it swings below the screen-grid bias these secondary electrons—indicated by the dotted arrow—will be drawn to the screen-grid. With a suppressor-grid, however, as shown in Fig. 5B, the secondary electrons are turned back by the effect of the zero bias, and distortion is avoided.

Hence when a suppressor-grid is used, the plate voltage may be allowed to swing lower with respect to the screen-grid voltage. Lowering of the instantaneous plate voltage also permits an increase in the amplitude of the radio-frequency plate potential for a given D.C. plate voltage.

Now, if the suppressor-grid is disconnected from the filament and given a separate negative bias, it will be found that the plate current varies substantially linearly with the suppressor-grid bias over a wide range of negative values (see Fig. 6, pg. 330). Thus the suppressor-grid may be used as a modulating electrode. A new type of modulator is obtained in this way which retains the high plate efficiency of the pentode.

It is possible to design such a tube so that approximately the maximum output is obtained with zero potential on the suppressor-grid. Since no positive swing is required, no current is drawn by the suppressor-grid, and negligible power is needed for modulation. This constitutes the principal superiority of suppressor-grid modulation over both plate and grid modulation. Since the suppressor-grid can be driven on a voltage basis, without the expenditure of appreciable energy, it is not necessary to supply high amplification for the audio-frequency power.

The 312A tube, shown in Fig. C, was designed for such use, and has the suppressor-grid characteristic shown in Fig. 6.

The upper end is purposely saturated in the positive region very near zero bias, so as to obtain maximum power without driving the grid positive. The shape of the characteristic near its lower end is affected by the degree of screening furnished by the suppressor-grid.

At the negative peaks of audio modulation, practically all the electrons should be repelled, reducing the plate current to zero. If the suppressor-grid does not shield the plate adequately, as at the end of the grid structure, a non-linear

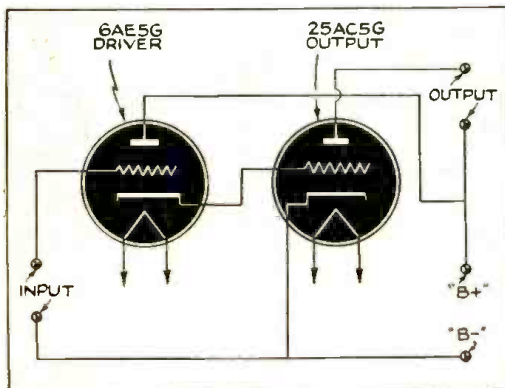

Fig. 9

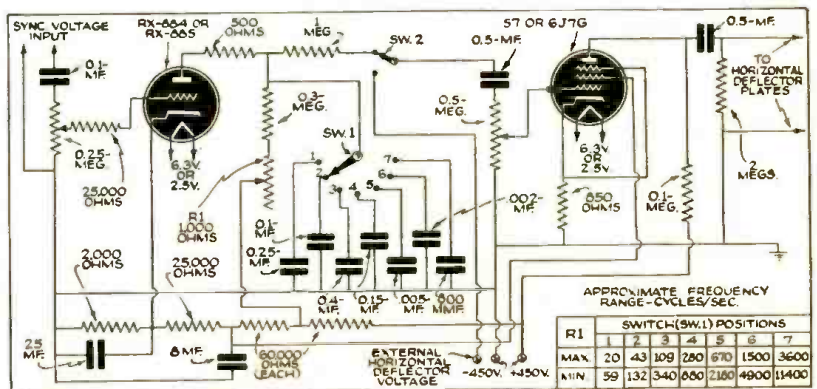

Fig. 14

FOR 1939

"toe" of the characteristic appears, and the plate current cannot be reduced to zero, which prevents attaining 100 per cent modulation. In the 312A tube, metal shields, one of which may be seen in circle, in Fig. C, are attached to the ends of the grid structure to reduce the "toe" of the characteristic to insignificant proportions.

In addition to this function, the suppressor end-shielding assists the screen grid in reducing the grid-to-plate capacity. In the 312A tube, where the capacity is a 10th of what it would be without the end shields, it is unnecessary to neutralize for any normal use of the tube. This is especially advantageous in mobile radio transmitters where multi-frequency operation, together with severe weight and space limitations, demands a minimum of adjustment in band changing or tuning. The small size and light weight of the 312A also contribute to its usefulness in the mobile transmitter field.

Although this tube, and the type 322A described below, were developed primarily for use as suppressor-grid modulators, they may also be operated with high plate efficiency as oscillators, as amplifiers, or as either of the other 3 types of modulators. Like other pentodes they have a high gain and thus require little radio-frequency driving power. These advantages of the new tubes, combined with their comparatively high output for the plate voltage used, give them a wide field of usefulness. There is no additional data available (concerning characteristics and terminal connections) at this writing.

Data supplied by: Bell Telephone Laboratories.

322A

The 322A tube, shown at right in Fig. C, is a later development, and is capable of providing more than twice the output power of the 312A. It has the additional advantage of somewhat higher overall efficiency due to the relatively lower screen-grid current needed. This is secured by lining up the wires of the control-grid and the screen-grid so that the latter, while having normal electrostatic influence upon the space current, does not intercept as many electrons as it otherwise would. There is no additional data available (concerning characteristics and terminals) at this writing.

Data supplied by: Bell Telephone Laboratories.

TELEVISION TUBES

2109

An *electromagnetic-deflection* Videotron (television receiving cathode-ray tube) with a 9-in. screen of medium-peristence type has just been announced. See Fig. D.

Features of the 2109 Videotron include a ceramic-mounted electron gun, supported by mica springs to obviate possibility of knocking it off center, double getter flashing for extra-high vacuum and long life, fine trace for 441-line definition, a specially-processed fluorescent screen which produces black and white images with 40-deg. of light contrast, high brilliance and no defocusing at extremes of sweep.

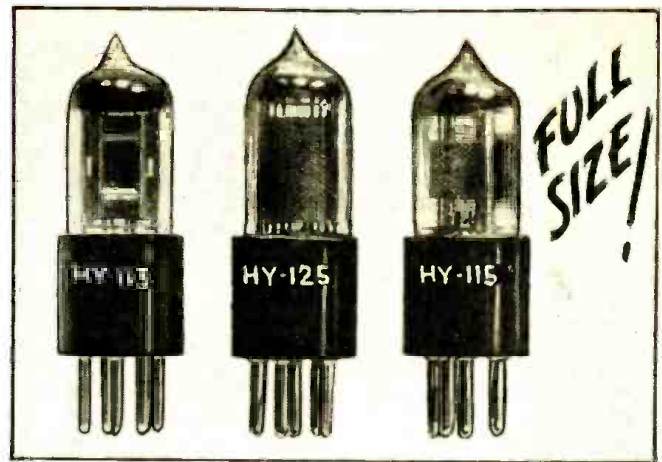

Fig. H

Characteristics data are given in Table VI. Terminal connections are shown in Fig. 7.

Data supplied by: National Union Radio Corp.

2112

This tube is a 12-in. Videotron having identical electrical characteristics and terminal connections with those of the type 2109 described above. The mechanical characteristics differ, however, as shown in Table VI. See photo, Fig. D.

Data supplied by: National Union Radio Corp.

906

This new *electrostatic-deflection*, high-vacuum C-R. tube has been designed for use in small television receivers and other similar applications. Due to its size (approx. 12 x 3 ins. dia.) and the brilliance obtainable, it is especially suitable for use in compact equipment.

The type 906 will be found useful where a cathode-ray tube of medium size is desired. This field includes radio manufacturers, broadcasting stations, experimental laboratories, radio amateurs, radio experimenters, radio Servicemen, colleges, radio trade schools and wherever television is under consideration or development. It may be used to replace any cathode-ray tubes bearing the same type number, as well as types H7-2. and 2003.

See photo, Fig. E; terminals are shown in Fig. 8; and, characteristics data are given in Table VII.

Data supplied by: Hygrade Sylvania Corp.

MISCELLANEOUS

6AE5G

In 110 V. A.C.-D.C. receivers a low-mu driver is required to provide positive grid bias and to center the plate current at the nominal value of 45 ma. This necessitated the design

(Continued on following page)

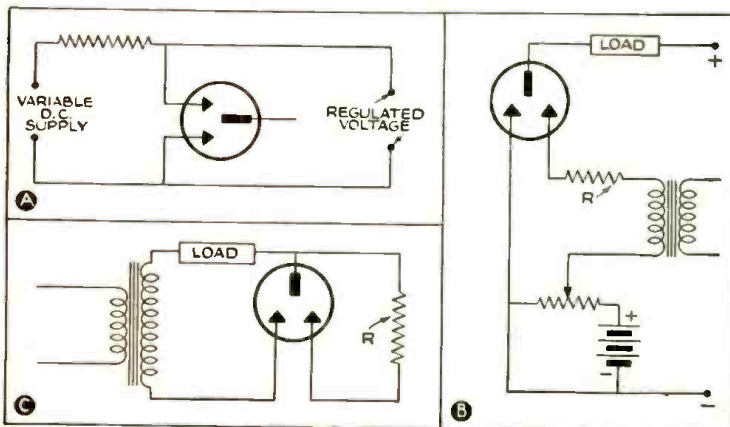

Fig. 17



Fig. F



Fig. G



Fig. I

(Continued from preceding page)

of a new driver, the 6AE5G. (A photo is not available.) This tube when operated in combination with another new tube, the 25AC5G, provides 2 W. of power output; see Fig. 9. As usual with *dynamic-coupled* amplifiers, the positive bias for the output tube and the negative bias for the driver are automatically provided by the circuit. A high value of resistance is permitted in the grid circuit of the driver, allowing the plate of the first audio to operate into a lightly loaded circuit. Since this coupling resistor is connected to the input driver rather than the output tube, grid current trouble, often encountered with other A.C.-D.C. power output tubes, is eliminated. For typical A.C.-D.C. receivers, a 6Q7G should be used for the detector and first audio with a 0.25-meg. plate resistor and 1.05 V. bias.

Characteristics data are given in Table VIII; terminal connections, in Fig. 10.

Data supplied by Triad Mfg. Co.

25AC5G

The Triadyne 25AC5G is a positive grid power amplifier triode designed particularly for dynamic-coupled class "A" operation, similar to the 6AC5G. This new output tube requires a 25 V. heater potential and its 0.3-ampere heater permits its use in series heater circuits commonly employed in A.C.-D.C. receivers.

The 25AC5G may also be operated at 180 plate volts. The tube offers an excellent solution to the tube complement problem in low-voltage A.C. receivers when it is economically feasible to operate the heaters in series and to use a small inexpensive transformer for the plate supply. A type 6P5G (octal base equivalent of a 76) may be used as the driver. This combination delivers 2 W. of power output. If more power is desired, a type 37 driver may be used, providing 2.7 W.

The simple construction and conservative wide element spacing of the 25AC5G insures against life problems and failures in the field. The tube offers a most inexpensive manner of increasing the number of tubes in a receiver. This is obvious because of the inherent low cost of both the driver and output tubes and the absence of circuit components.

Characteristics data are given in Table IX; terminal connections, in Fig. 11. (Photo of tube unavailable at this writing.)

Data supplied by Triad Mfg. Co.

RK62

The RK62 is the permanent designation which has been assigned to the gas-filled triode described in the July, 1938, issue of *QST* and originally called the QY4.

In order to increase the usefulness of this tube in portable equipment several changes have been made among which is the use of the new low-drain filament which may be operated from a standard 1.5 volt drycell or flashlight battery. When used in the standard self-quenching super-regenerative circuit the RK62 acts as a very sensitive detector-thyratron and with no more than 45 volts plate supply has sufficient power gain to operate a relay when a signal is received.

NEW TUBES

Model airplane enthusiasts immediately recognized the value of this tube in remote control devices for their 'planes but the RK62 also has great possibilities in other remote control equipment where light weight is important.

The tube must always be operated with sufficient series resistance in the anode circuit to limit the anode current to the maximum rated value.

When operating properly the tube should be oscillating at audio-frequency except during reception of a radio-frequency signal whereupon the audio-frequency oscillation should disappear.

The useful life of the tube depends upon the anode current and is shorter than that of other Raytheon Amateur Types. The life may be prolonged by operating the tube with as low an anode current as possible.

A T-9 bulb is used; terminals are shown in Fig. 12; and characteristics are given in Table X. An illustration of the tube is not available at this writing.

Data supplied by: Raytheon Production Corp.

RX884

The RX884 is a gas-filled triode but is designed for use in sweep circuit oscillators or as a grid-controlled rectifier. The RX884 should be in demand for experimental purposes.

Characteristics data are given in Table XI; an ST-12-D bulb is used; terminals and symbol are given in Fig. 13. Also see linear sweep-circuit oscillator and amplifier diagram, Fig. 14. An illustration of the tube is not available at this writing.

Data supplied by: Raytheon Production Corp.

RX885

Like the 6.3-V. RX884 (described above), the 2.5-V. RX885 is a gas-filled triode designed for use in sweep-circuit oscillators or as a grid-controlled rectifier. The RX885 is suitable for many experimental purposes. It also will be needed for replacement in the sweep circuits of oscilloscopes now in use by hundreds of Servicemen and laboratories.

See Table XI for characteristics; and Fig. 15 for symbol. Also see linear sweep-circuit oscillator and amplifier diagram, Fig. 14. An illustration of the tube is not available at this writing.

Data supplied by: Raytheon Production Corp.

2A4G

The 2A4G is a hot-cathode, argon-filled, single-grid, thyratron tube particularly useful in applications where constancy of characteristics is necessary even with large variations in ambient (surrounding) temperature.

Terminal connections and symbol are shown in Fig. 16; the ST-12-D bulb is employed; characteristics are given in Table XII. An illustration of the tube is not available at this writing.

Data supplied by: Raytheon Production Corp.

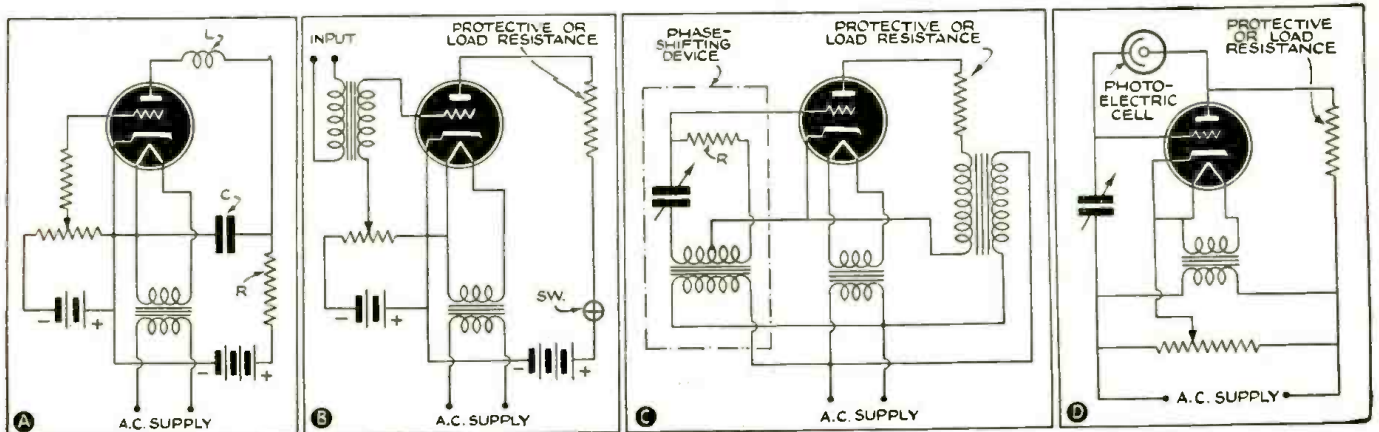

Fig. 19

FOR 1939

313C

The 313C is a double-gap, cold-cathode, gas-filled tube for use as a relay, rectifier or voltage regulator in special circuits. The 313C replaces the 313A (*Radio-Craft*, March 1938).

The elements of this tube consist of 2 similar control electrodes and 1 anode. The conduction path between the control electrodes is known as the *control-gap*. The conduction path between either control electrode and the anode is known as the *main-gap*.

The glass bulb is completely opaqued; so that the charge is not visible while the tube is operating; it's shown partly opaqued, in Fig. F.

Overall dimensions are: length (max.), 3-13/32 ins.; dia. (max.), 13/16 ins.

The "deionization time" given in Table XIII is the time during which the voltage must be removed from the tube in order that the discharge shall not be reestablished when the voltage is restored.

The "transfer time" mentioned in the same Table is the time during which the control-gap must be energized in order that the discharge may transfer to the main-gap. It depends upon the amount of current flowing in the control-gap and on the main-gap voltage.

Circuit Fig. 17A shows the control-gap of the 313C employed as a *voltage regulator*; Fig. 17B shows the tube used as a *relay*; and Fig. 17C shows the tube used as a *rectifier*. The tube symbol and terminal connections are shown in Fig. 18. Characteristics data are given in Table XIII.

See NOTE at end of article.

Data supplied by: Western Electric Co.

338A

The 338A is a 3-element, argon-filled thyratron, with an indirectly-heated cathode. See Fig. G; overall length is 4-7/16 ins., and dia. 1-9/16 ins.

It is primarily a rectifier of low internal impedance whose conduction cycle is determined by the relative instantaneous grid and anode potentials.

It is intended for use in special circuits as a relay or trigger-action device.

A few of its possible uses are: as a controlled-frequency oscillator giving a square waveform, as a voltmeter or volume level-indicator, as a source of sweep-voltage for a linear time axis, or as a variable-voltage rectifier.

A circuit for using the tube as a thyratron producing a sawtooth, current wave, is given in Fig. 19A; resistor R ordinarily will have a value of at least 0.1-meg., and the product of RC (C in farads) should be approximately equal to the desired fundamental period. Used as a relay operating from D.C., the diagram of Fig. 19B may be used; a "lock-in" feature is thus secured since the anode potential must be removed momentarily in order to restore the tube to the non-conducting condition. Used as a relay tube operating from A.C., as shown in Fig. 19C, "lock-in" is not secured, but the average anode current may be controlled by the relative phase of grid and anode potentials. A photocell may be used, in place of the resistor, R, in the phase-shifting device of Fig. 19C, as shown in Fig. 19D.

Tube terminal connections are given in Fig. 20; characteristics are given in Table XIV. See NOTE at end of article.

Data supplied by: Western Electric Co.

HY113

The "Bantam, Jr.", type HY113 triode may be used as an R.F. oscillator, or A.F. low-power output amplifier. It is illustrated in Fig. H; it is only 2-3/16 ins. long. Symbol and terminal connections are given in Fig. 21; characteristics data are given in Table XV.

Data supplied by: Hytronic Laboratories, Division of Hytron Corp.

HY115

The "Bantam, Jr.", type HY115 pentode may be used as an A.F. interstage or output amplifier. Overall height is 2-3/16 ins.; terminals are shown in Fig. 22; the tube is shown in Fig. H; and, data are given in Table XVI.

Data supplied by: Hytronic Laboratories, Division of Hytron Corp.

HY125

The "Bantam, Jr.", type HY125 pen-

tode shown in Fig. H may be used as an A.F. power output amplifier. Data are given in Table XVII; and, the symbol is shown in Fig. 22.

Data supplied by: Hytronic Laboratories, Division of Hytron Corp.

WL651

The *ignitron* principle was developed by the W. E. & M. Co. Research Laboratories several years ago and at that time a glass bulb was used on the tube. The WL651, one of several new types, however, uses an improved construction. It is illustrated in Fig. I; overall length is 15 3/4 ins.

The ignitron consists of a mercury pool or cathode, an igniter crystal which projects part way into the mercury pool and an anode near the top of the bulb. Passage of current through the igniter from an outside source produces ionization in the vicinity of the igniter much as a spark is caused by the spark plug in an automobile cylinder. As soon as the cathode spot is formed the current can pass through the tube between the cathode and anode in amount limited largely by the associated external circuit. This means that the ignitron is ideally suited for such high surge current industrial service as the control of spot and seam welders.

In order to make the ignitron more suitable for industrial applications an extensive development program has resulted in the introduction of several types which are of metal except for a small glass insulating tubing which electrically separates the anode circuit from the main portion of the tube. This construction also makes it convenient to water-cool the container or walls of the tube thereby facilitating the maintenance of the tube at the desired temperature for most stable operation. The size of tube to use depends upon the thickness and kind of material which is being handled and upon the rapidity with which the welding operations are to be handled.

Characteristics data are given in Table XVIII; terminal connections are unavailable at this writing.

Data supplied by: Westinghouse Elec. & Mfg. Co.—Lamp Division.

(Continued on following page)

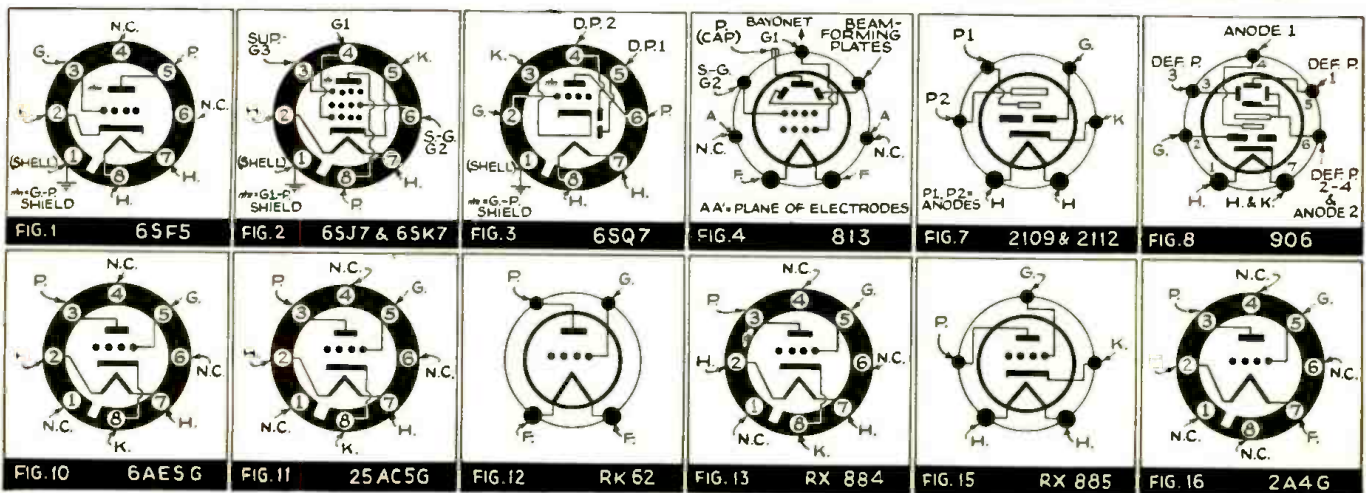

(Continued from preceding page)

GLASS BALLAST (RESISTOR) TUBES

K49AG, BL49DG, BM55BG, L36DJG, BK42CG, BM42BG, L36DG, L49BJG

The development of ballast (resistor) tubes has been quickly and widely accepted by set manufacturers in preference to *line-resistor-cords*. Incorporated in A.C.-D.C. receivers, ballast tubes have been found to have many advantages over line cords, not alone from the standpoint of construction in the set manufacturer's plant, but also to the user.

Line cords become hot in operation and the average man, woman or child in the home inherently shies away from a warm electric cord, regarding it as dangerous and liable to give off a shock. This timidity is further aggravated by the necessity for extending the cord for its full length prior to operating the receiver. This requisite may not fit in with the scheme of furniture layout, leading to a natural inclination on the part of the user to cut the cord, which immediately ruins it.

Ballast tubes at once overcome all these objections. In addition, it is simple for a user to replace a burned-out ballast tube with a new one. The danger factor, with ballast tubes, is immediately converted to a safety factor in the home.

Ballast tubes carry no restrictions on the part of the Underwriters Laboratories, as is the case of the line cords, which are not generally approved by the Laboratories, states Arcturus.

Newest additions to one line of ballast tubes have the characteristics given in Table XIX.

Data supplied by: Arcturus Radio Tube Co.

Additional information, such as graphs, specific circuit arrangements, and electrical values of components shown in circuits herein illustrated when used under particular conditions, may be obtained directly from the respective manufacturer. Such inquiries may be sent directly to the manufacturer, or in care of *Radio-Craft*.

NOTE—To avoid misunderstandings, please note the following sales restrictions are for use only: (1) in established radio telephone broadcasting stations; (2) with W. E. vacuum tube apparatus; (3) with non-W. E. vacuum tube apparatus manufactured under Bell System patent licenses; (4) by licensed amateurs in their radio telephone stations; and, (5) by state, county and municipal governments in their established police radio systems.

6SF5—TABLE I

Tentative Characteristics and Ratings

Heater voltage (A.C. or D.C.)	6.3 volts
Heater current	0.3 ampere
Direct interelectrode capacities: °	
Grid to plate	2.6 mmf.
Grid to cathode	4.2 mmf.
Plate to cathode	3.8 mmf.
Maximum overall length	2 3/4"
Maximum diameter	1 5/16"
Base	Small wafer octal 6-pin

°With shell connected to cathode.

Amplifier—Class A

Operating conditions and characteristics:	
Heater voltage*	6.3 volts
Plate voltage	250 max. volts

Grid voltage	-2	volts
Amplification factor	100	
Plate resistance	66,000	ohms
Transconductance	1,500	micromhos
Plate current	0.9	milliamperes

*In circuits where the cathode is not directly connected to the heater, the potential difference between heater and cathode should be kept as low as possible.

6SJ7—TABLE II

Tentative Characteristics and Ratings

Heater voltage (A.C. or D.C.)	6.3	volts
Heater current	0.3	ampere
Direct interelectrode capacities: °		
Grid to plate	0.005 max.	mmf.
Input	6.0	mmf.
Output	7.0	mmf.
Maximum overall length	2 3/4"	

°With shell connected to cathode.

Amplifier—Class A

Operating conditions and characteristics:			
Heater voltage* (see *, above, for 6SF5)			
6.3	6.3	volts	
Plate voltage	100	250 max. volts	
Screen voltage	100 max.	100 max. volts	
Grid voltage	-3	-3	volts
Suppressor	Connected to cathode at socket		
Plate current	2.9	3.0	milliamperes
Screen current	0.9	0.8	milliamperes
Amplification factor (approx.)	1100	2500	
Plate resistance (approx.)	0.7	1.5	megohms
Transconductance	1575	1650	micromhos

6SK7—TABLE III

Tentative Characteristics and Ratings

Heater voltage (A.C. or D.C.)	6.3	volts
Heater current	0.3	ampere
Direct interelectrode capacities: °		
Grid to plate	0.005 max.	mmf.
Input	6.0	mmf.
Output	7.0	mmf.
Maximum overall length	2 3/4"	

°With shell connected to cathode.

Amplifier—Class A

Operating conditions and characteristics:			
Heater voltage*			
6.3	6.3	volts	
Plate voltage	100	250 max. volts	
Screen voltage	100 max.	100 max. volts	
Grid voltage	-3 min.	-3 min. volts	
Suppressor	Connected to cathode at socket		
Plate current	8.9	9.2	milliamperes
Screen current	2.6	2.4	milliamperes
Amplification factor (approx.)	475	1600	
Plate resistance (approx.)	0.25	0.8	megohm
Transconductance	1900	2000	micromhos
Grid voltage for trans-conductance = 10 micromhos	-	-35	volts

*In circuits where the cathode is not directly connected to the heater, the potential difference between heater and cathode should be kept as low as possible.

6SQ7—TABLE IV

Tentative Characteristics and Ratings

Heater voltage (A.C. or D.C.)	6.3	volts
Heater current	0.3	ampere
Direct interelectrode capacities—		
Triode unit: °		
Grid to plate	1.8	mmf.
Grid to cathode	4.2	mmf.
Plate to cathode	3.4	mmf.
Maximum overall length	2 3/4"	

°With shell connected to cathode.

Triode Unit—Class A Amplifier

Operating conditions and characteristics:		
Heater voltage*	6.3	volts
Plate voltage	250 max.	volts
Grid voltage	-2	volts
Amplification factor	100	

NEW TUBES

Plate resistance	91000	ohms
Transconductance	1100	micromhos
Plate current	0.8	milliamperes

*In circuits where the cathode is not directly connected to the heater, the potential difference between heater and cathode should be kept as low as possible.

813—TABLE V

Tentative Characteristics and Ratings

Filament voltage (A.C. or D.C.) (± 5%)	10.0	volts
Filament current	5	amperes
Transconductance, for plate cur. of 50 ma.	3750 approx.	micromhos
Direct interelectrode capacities:		
Grid-plate (with external shielding)	0.2 max.	mmf.
Input	16.3	mmf.
Output	14	mmf.

Maximum Ratings and Typical Operating Conditions

As R.F. Power Amplifier and Oscillator—Class C Telegraphy	
Key-down conditions per tube without modulation °	
D.C. plate voltage	2000 max. volts
D.C. screen voltage (Grid No. 2)	400 max. volts
D.C. grid voltage (Grid No. 1)	-300 max. volts
D.C. plate current	180 max. milliamperes
D.C. grid current	25 max. milliamperes
Plate input	360 max. watts
Screen input	22 max. watts
Plate dissipation	100 max. watts

Typical operation:		
D.C. plate voltage	1250 1500 2000	volts
D.C. screen voltage	300 300 400	volts
D.C. grid voltage* (Grid No. 1)	-60 -70 -90	volts
Peak R.F. grid voltage	145 150 160	volts
Beam-forming plate voltage†	0 0 0	volts
D.C. plate current	180 180 180	milliamperes
D.C. screen current	23 20 15	milliamperes
D.C. grid current (approx.)	7 6 3	milliamperes
Screen resistor	42000 60000 107000	ohms
Grid resistor	8500 11700 30000	ohms
Driving power (approx.)	1 0.8 0.5	watt
Power output (approx.)	155 190 260	watts

*Grid voltages are given with respect to the mid-point of filament circuit operated on A.C. If D.C. is used, each stated value of grid voltage should be decreased by 7 volts and the circuit returns made to the negative end of the filament.
 †Beam-forming plates should be connected to the mid-point of filament circuit operated on A.C. or to the negative end of the filament when a D.C. filament supply is used.
 °Modulation essentially negative may be used if the positive peak of the audio-frequency envelope does not exceed 115% of the carrier conditions.

2109 and 2112—TABLE VI

Characteristics

Heater:	Coated unipotential cathode	
Voltage:	2.5 A.C. or D.C. volts	
Current:	2.1 amp.	
Fluorescent screen		
Material	Phosphor No. 2	
Color of fluorescence	White	
Direct interelectrode capacity:		
Grid No. 1 to all other electrodes	12 max. mmf.	
2112	2109	
Overall length	25" ± 3/8"	21" ± 3/8"
Maximum diameter	12 1/4"	9 1/4"
Bulb	J-98	J-72

Maximum Ratings and Typical Operating Conditions	
High-voltage electrode (Anode #2) voltage	7000 max. volts
Focusing electrode (Anode #1) voltage	2000 max. volts

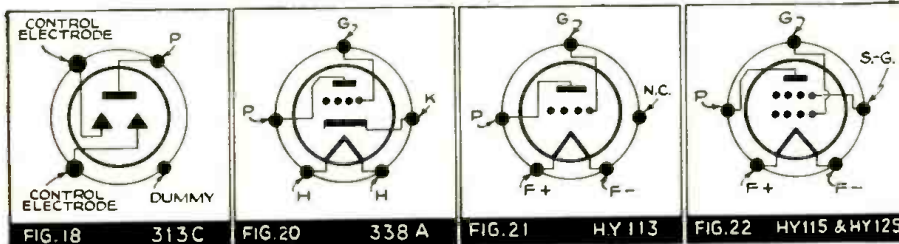

FOR 1939

Acceleration electrode (Grid #2) voltage 250 max. volts
 Control electrode (Grid #1) voltage Never positive
 Grid #1 voltage for current cut-off* -75 approx. volts
 Fluorescent-screen input power/sq. cm. 10 max. m w
 Typical operation:
 Heater voltage 2.5 2.5 2.5 volts
 Anode #2 voltage 3000 4500 6000 volts
 Anode #1 voltage 625 925 1250 approx. volts
 Grid #2 voltage 200 250 250 volts
 Grid #1 voltage Adjusted to give suitable luminous spot
 Grid #1 signal-swing voltage** 20 25 25 approx. volts
 *With 250 volts on grid #2, and 1450 volts on anode #1.
 **Peak-to-peak value for optimum contrast.

906—TABLE VII

Tentative Characteristics
 Heater voltage A.C. or D.C. 2.5 volts
 Heater current 2.1 amperes
 Second anode voltage 1500 volts max.
 First anode voltage 550 volts max.
 Control-grid voltage Never positive
 Grid voltage for current cut-off* -60 volts approx.
 Peak voltage between second anode and any deflecting plate 600 volts max.
 Screen power density 10 Mw/cm² max.

Operating Conditions and Characteristics

Heater voltage 2.5 volts
 Heater current 2.1 amperes
 Second anode voltage 600 800 1000 1500 volts
 First anode voltage** 170 230 285 475 volts approx.
 Control-grid voltage Varied to control spot intensity
 Deflection sensitivity:
 Plates D₁ and D₂ 0.55 0.41 0.33 0.22 mm/volt D.C.
 Plates D₃ and D₄ 0.58 0.44 0.35 0.23 mm/volt D.C.
 *With approximately 400 volts (to focus) on first anode.
 **For focus.

SCREEN

Fluorophor No. 1 (furnished unless otherwise specified) Color Green
 No. 2 Yellow
 (Others available on request.)
 Base—Medium 7-pin—R.M.A. Standard M8-081
 Note—If sharply defined spot is not required 400 volts may be used on the second anode with a proportional reduction in the first anode voltage.

6AE5G—TABLE VIII

Heater Voltage 6.3 Coated Unipotential Cathode
 Current 0.3 Volts A.C.-D.C. Amperes
 Amplifier Class A
 Plate 95 volts
 Grid -15 volts
 Amplification factor 4.2
 Plate resistance 3500 ohms
 Transconductance 1200 micromhos
 Plate current 7 milliamperes

25AC5G—TABLE IX

Heater Voltage 25.0 Coated Unipotential Cathode
 Current 0.3 Volts A.C.-D.C. Amperes
 Plate Voltage 180 max. volts
 Dissipation 10 max. watts

Static and Dynamic Characteristics

Plate voltage 110 volts
 Grid voltage +15 volts
 Amplification factor 58
 Plate resistance 15200 ohms
 Transconductance 3800 micromhos
 Plate current 45 milliamperes
 Grid current 7 milliamperes

RK62—TABLE X

Direct interelectrode capacities
 G to A (Grid to anode) 2.5 mmf.
 G to F (Input electrode) 2.7 mmf.
 A to F (Output electrode) 2.8 mmf.

Ratings and nominal characteristics

Filament voltage 1.4 volts
 Filament current 0.05 amp
 Maximum D.C. anode voltage 45 volts
 Maximum D.C. anode current 1.5 ma
 Anode voltage drop (approx.) 15 volts
 (At D.C. grid voltage = 0 volts; I_p = 1.6 ma.)

Typical operation

D.C. anode voltage 30 to 45 volts
 D.C. signal anode current 1 to 1.5 ma
 With signal anode current 0.1 to 0.5 ma
 Relay resistance 5000 to 10000 ohms

RX884 and RX885—TABLE XI

Heater rating RX-884 RX-885
 Heater voltage 6.3 2.5 volts
 Heater current 0.6 1.4 amp

Direct interelectrode capacities

G to A (Grid to anode) 3.5 mmf.
 G to K (Grid to cathode) 3.5 mmf.
 A to K (Anode to cathode) 2.5 mmf.
 Tube voltage drop (approx.) 16 volts

Sweep-circuit oscillator

Maximum anode voltage 300 volts
 (Instantaneous)
 Maximum peak voltage 350 volts
 (Between any two electrodes)

Maximum peak anode current 300 ma
 Maximum average anode current For freq. below 200 cps 3 ma
 For freq. above 200 cps 2 ma

Grid-resistor

Grid-controlled rectifier†

(For frequencies below 75 cycles per second)

Maximum peak voltage (between any two electrodes) 350 volts
 Maximum peak anode current 300 ma
 Maximum average anode current 75 ma
 (Averaged over period of not more than 30 sec.)

Grid resistor

†Heater voltage should be applied for 30 seconds before drawing anode current.

*The resistance of the grid resistor should be not less than 1000 ohms per maximum instantaneous volt applied to the grid. Resistance values in excess of 500000 ohms may cause circuit instability.

The cathode should preferably be connected directly to the mid-tap of the heater circuit. In circuits where the cathode is not connected directly to the heater, the heater may be made negative with respect to the cathode by a potential difference not to exceed 100 volts provided the peak voltage between any electrode and the heater does not exceed 350 volts.

2A4G—TABLE XII

Ratings and Characteristics
 Filament voltage 2.5 volts
 Filament current 2.5 amp
 Maximum anode voltage (Instantaneous) Forward 200 volts
 Inverse 200 volts
 Maximum voltage between any two electrodes 250 volts
 Maximum anode current Peak 1.25 amp
 Average 0.10 amp
 Maximum averaging time 45 sec
 Tube voltage drop 15 volts
 Cold starting time 2 sec

313C—TABLE XIII

Ratings
 Max. peak control-electrode current 30 ma
 Max. average control-electrode current (averaged over 1 sec.) 10 ma
 Max. peak reverse current in main-gap 5 ma

Characteristics

Nominal control-gap breakdown voltage 70 V.
 Nominal control-gap sustaining voltage 60 V.

Nominal main-gap breakdown voltage 175 V.
 Nominal main-gap sustaining voltage 75 V.
 Transfer current 5 microA. (max.)
 Nominal deionization time Main-gap 10 millisecc.
 Control-gap 3 millisecc.
 Transfer time (for a control-gap current of 10 microA.) 200 microsec. (approx.)

338A—TABLE XIV

Heater Rating

Heater potential 10 V.
 Nominal heater current 0.5-A.
 Required heating time 60 sec.

Caution No. 1: Always allow cathode temperature to reach normal operating value before anode current is drawn.

Operating Conditions

Approx. tube voltage drop 15 V.
 Max. peak voltage between anode and grid 325 V.
 Max. instantaneous anode current 0.6-A.
 Max. average anode current 0.1-A.
 Max. time of averaging anode current 5 sec.
 Max. instantaneous grid current 0.01-A.
 Max. voltage between heater and cathode 50 V.
 Operating ambient temp. range -20° to 50°C.
 Normal deionization time 1,000 microsec.

Caution No. 2: Sufficient resistance must always be included in the grid circuit, to limit the negative grid potential to 10 V. when anode current is flowing, to prevent short tube life.

HY113—TABLE XV

R.F. Oscillator A.F. Output
 Filament voltage 1.4 volts 1.4 volts
 Filament current 70 ma. 70 ma.
 Plate voltage 45 volts 90 volts
 Grid voltage -4.5 volts -7½ volts
 Plate current 0.4 ma. 2.0 ma.
 Transconductance 250 mmhos. 500 mmhos.
 Amp. factor 6.3 6.3

Plate resistance 25000 ohms 12600 ohms
 Load impedance 20000 ohms
 Power output 17.5 mw

HY115—TABLE XVI

Interstage A.F. Output
 Filament voltage 1.4 volts 1.4 volts
 Filament current 70 ma. 70 ma.
 Plate voltage *45 volts 45 volts
 Screen voltage 22½ volts 45 volts
 Grid voltage -1½ volts -1½ volts
 Av. plate current 0.03 ma. 0.5 ma.
 Av. screen current 0.008 ma. 0.15 ma.
 Av. amp. factor 800 350
 Load impedance 0.9 megohm 75000 ohms
 Power output 5.5 mw.

*Through 1 megohm coupling resistor.

HY125—TABLE XVII

Filament voltage 1.4 volts
 Filament current 70 ma.
 Plate voltage 45 volts
 Screen voltage 45 volts
 Grid voltage -3.0 volts
 Av. plate current 0.9 ma.
 Av. screen current 0.2 ma.
 Load impedance 4000 ohms
 Power output 11.5 mw.

Note: Above pentode ratings with grid bias return to "A-" and suppressor-grid connected to "A+" (lead inside tube).

WL651—TABLE XVIII

Ratings
 Crest inverse volts 775
 Nominal average anode amps. 125
 Max. peak r.m.s. amps. 2800
 Ignitor volts, max. 200
 Ignitor amps., max. 25

BALLAST (RESISTOR) TUBES—TABLE XIX

Type	Characteristics						Basing Connection	To Replace
	Total Voltage Drop	Current Ratings (Amperes)	No. of Pilot Lamps	Type of Pilot Lamp	Pilot Lamp Voltage	Pilot Ballast Action		
K49AG	49	0.3	0	-	-	-	A	49A
BK42CG	42	0.3	2	40	5	Yes	C	BK42C
BL49DG	49	0.3	2	46	5	Yes	D	BL49D
BM42BG	42	0.3	1	50 or 51	5	Yes	B	BM42B
BM55BG	55	0.3	1	50 or 51	5	Yes	B	BM55B
L36DG	36	0.3	2	46	4.25	No	D	L36D
L36DJG	36	0.3	2	46	4.25	No	D"J"	6.126
L49BJG	49	0.3	1	46	4.25	No	B"J"	L49BJ

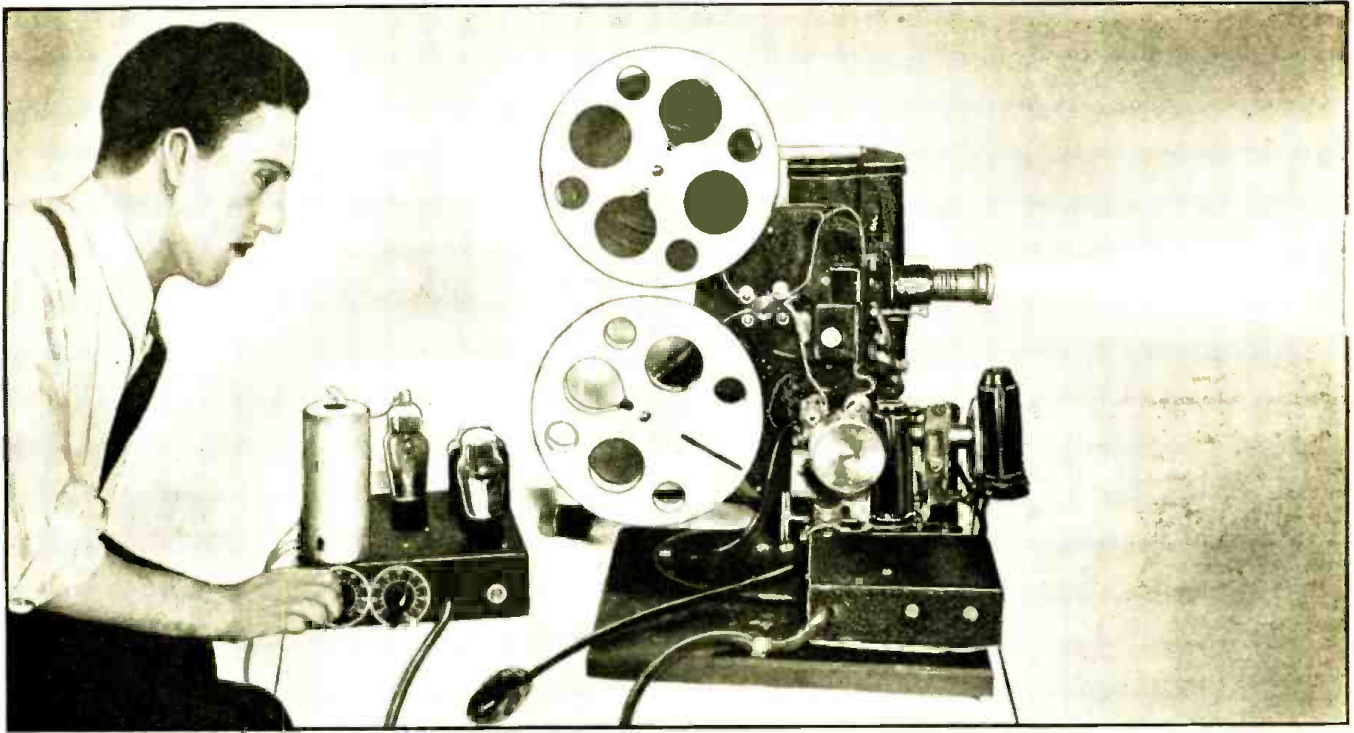

Fig. A. An "add-on" optical system and preamplifier pick off the sound from the film to modulate the oscillator (left) which is loosely coupled . . .

PLAY TALKIES THROUGH

Sound adds just as much to Home Movies as Television adds to radio—and in this first of 2 articles, a and how to profit by doing such work for schools, churches, etc. Patent has been applied for on this sys-

JACK ROBINS

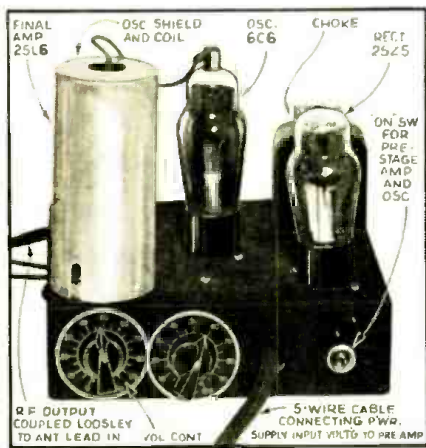

Fig. B. The Oscillator, seen at close range.

TENS of thousands of 16 mm. motion picture projectors are in use throughout the United States, and only a small—a very small—percentage of these are capable of reproducing sound. The reason for this is not any lack of available material (film libraries can supply any amount of talkie film); rather, it is because silent projectors cost about 1/10th as much as do sound projectors of comparable quality.

Realizing the need for cheap and simple 16 mm. sound movie equipment, the writer began experimenting with a sound system that might be added to any standard silent projector and which would, at a cost of only a few dollars, provide as perfect reproduction of sound-on-film as a radio set provides in reproducing broadcasts.

OLD "A.F." SYSTEM

The early stages of the laboratory work were concerned with the obvious method of using the audio stages of a radio receiver as a means of amplifying the output of a photoelectric or "PE." cell employed in conjunction with the usual talkie light source, and optical



system. These experiments were soon abandoned, due to the peculiar characteristics of sound-on-film. The reason for this is that straight audio amplifiers—such as those now used for the reproduction of 16 mm. home talkies—have certain linear characteristics, and with film and optical loss, frequency response is generally poor.

Unless these amplifiers are carefully designed to correct for such losses, and are then built with precision equipment, they are incapable of giving faithful reproduction of the sound recorded on film.

As a result of the experiments, a new approach to the problem was tested and found thoroughly satisfactory. That is, the use of a preamplifier and oscillator in conjunction with the optical system, the output of the oscillator being fed not into the radio receiver's audio stages, but into its 1st R.F. stage! In fact, the tonal quality obtained by feeding the motion picture's sound through the R.F. and I.F. stages of the radio receiver is superior to that of complete motion picture sound systems costing from \$300 to \$500! In other words, "wired radio" or *carrier-current telephony* solved the problem.

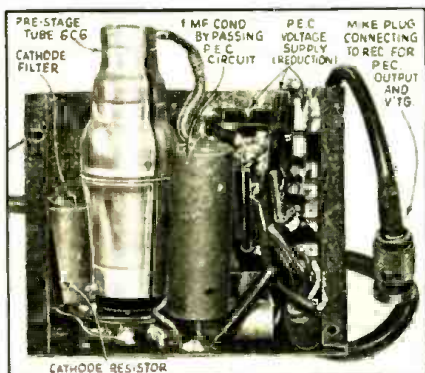
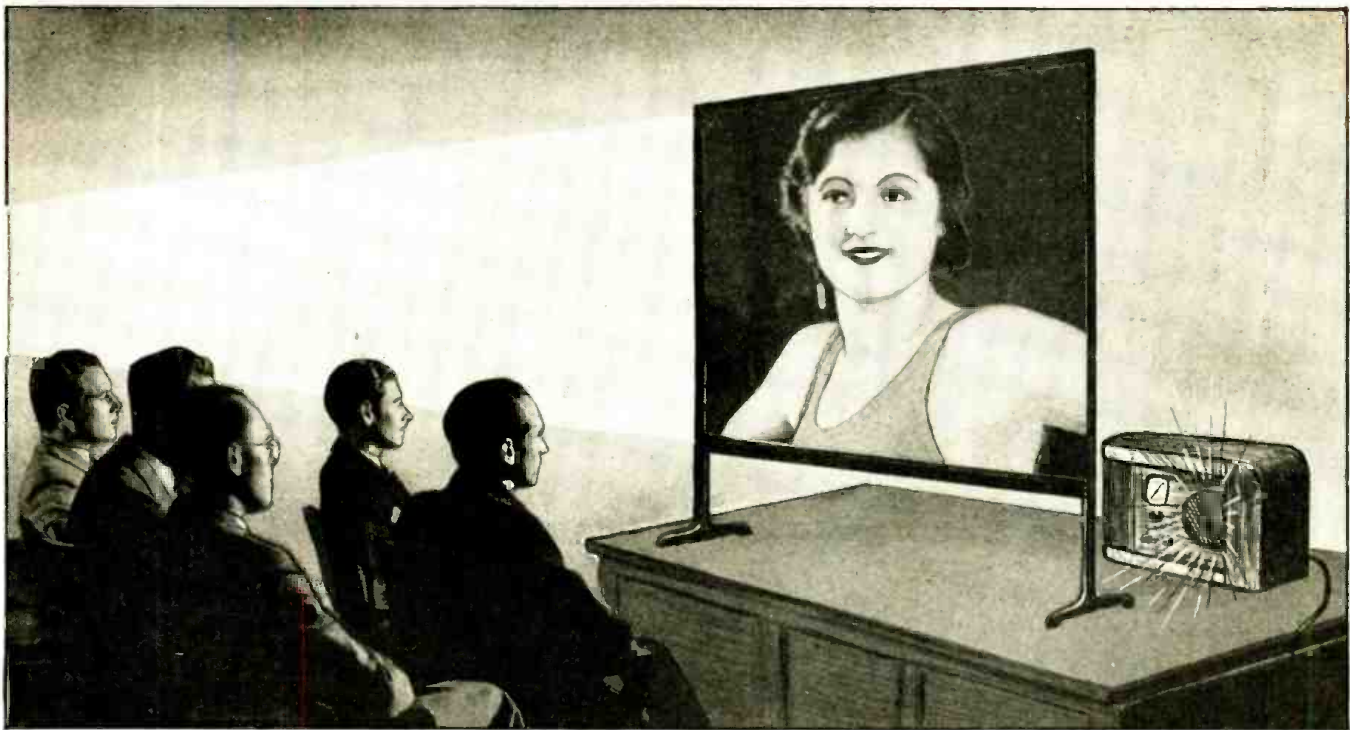

Fig. C. The Preamplifier, also in close-up.



... to a standard broadcast receiver shown behind the screen. The output lead of the oscillator is merely twisted around the antenna lead of the set.

YOUR RADIO RECEIVER

motion picture engineer tells you how to get sound on your projector with little expense and less work, them; you merely run 1 wire from the new movie unit to your radio set's antenna post, to get sound!

PART I

NEW "R.F." SYSTEM

Using this new system, in which the R.F. and I.F. stages of the radio receiver play an important part, the set's audio system provides as true a response to the recorded sound as is afforded by the set on the best of broadcast programs. The job of connecting the output of the film sound reproducer to the radio set is eliminated at the same time, for

the output of the oscillator may be coupled to the antenna input of the radio set by straight induction; a direct connection also may be used.

In this article, the complete sound reproduction apparatus, except for the optical system, will be described. The optical system offers no difficulties, and should be easily attached to any 16 mm. projector by the average experimenter.

The rest of the unit, for which constructional data follow, may be put together in about 3 hours, at a cost not exceeding \$5; the optical units will cost but little (if any) more; and the completed units should be easy to re-sell to schools, churches, industrial organizations, clubs, and even home movie fans at prices ranging up to \$50.

(Continued on following page)

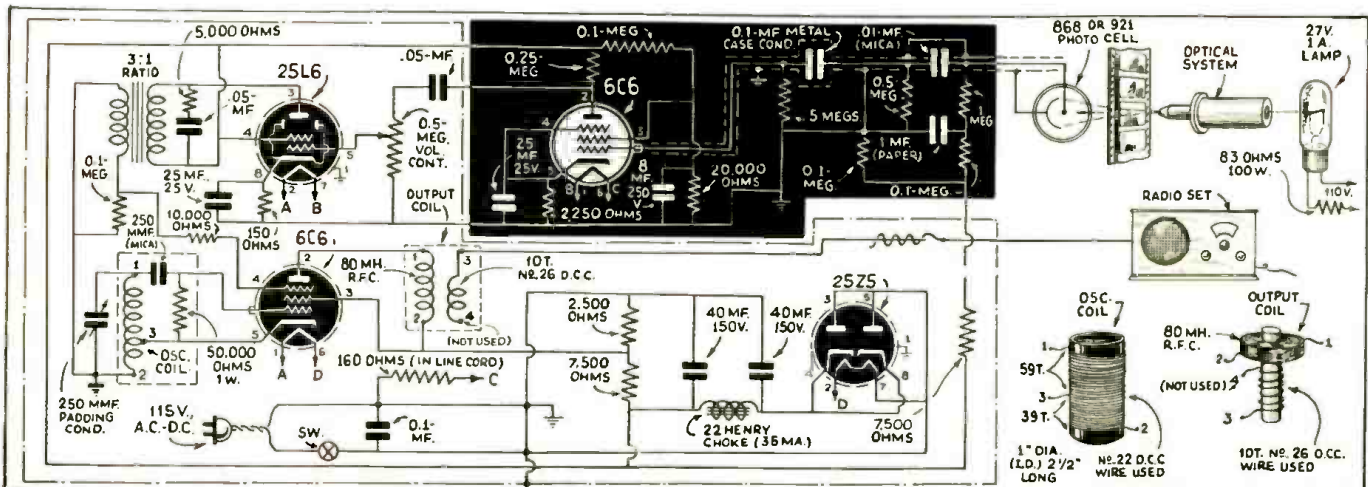

Fig. 1. Here's the schematic of the entire set-up. The talkie film's sound, preamplified, is fed by wired-radio to the antenna post of any radio set. A ground connection is not required. The black-background portion of the diagram is that of the preamplifier shown photographically in Fig. C on preceding page. (No. 26 D.C.C. wire, not No. 22, is correct size for osc. coil.)

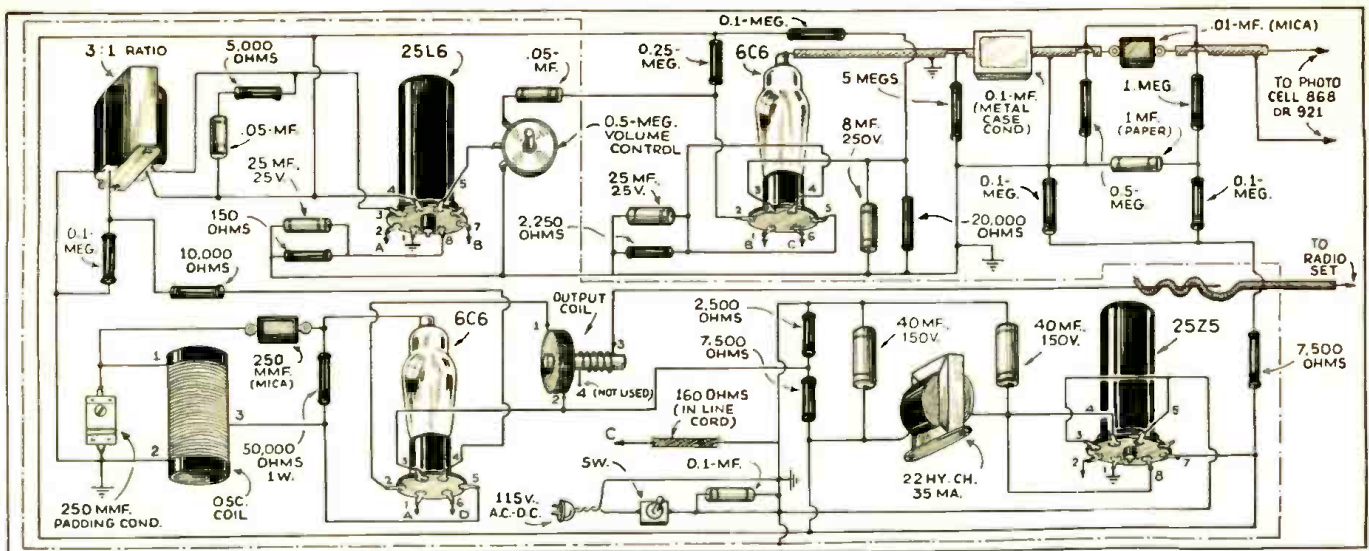

Fig. 2. The technicians' circuit of Fig. 1 is here simplified for beginners. Make your "silent" home-movie into a "talkie"!

(Continued from preceding page)

THE PREAMPLIFIER

The can which houses the preamplifier measures approximately $1\frac{1}{4} \times 4 \times 5$ inches, and serves as a complete shield for the unit as well as a base upon which the parts are mounted.

A length of shielded lead, about 6 inches long, is left protruding from the shield, for connection to the P.E. cell. Its shield is soldered to the can; its conductor connects to a 0.01-mf. mica condenser and a 1-meg. resistor. (The entire wiring of this unit is shown in Fig. 1.) The remaining side of this condenser connects to a 0.5-meg. resistor and to a 0.1-mf. metal case condenser, the case of which is grounded on the chassis can. The other terminal of this 0.1-mf. condenser connects to the control-grid of the 1st 6C6 tube.

Note especially the connection of this 1st 6C6 tube to the 2nd stage of the preamplifier. The plate of the 1st tube gets its voltage through a 0.25-meg. resistor in the lead which comes from the chassis housing the oscillator and power pack. The audio component is fed to the grid of the 2nd amplifier (a 25L6 tube) through a 0.5-mf. condenser, rated for a peak voltage of 400 V. The grid of this 2nd tube gets its bias through a 0.5-meg. variable resistor.

Due to the fact that high-frequency accentuation is usually desirable in reproducing sound-on-film, because of film and optical loss, a corrective filter is used on the primary of the output transformer. This filter consists of a 5,000-ohm resistor in series with a 0.05-mf. tubular condenser. It will be found that the effective load impedance on the 25L6 tube can be made practically constant for all frequencies, especially in the middle and upper audio ranges. This results in an improvement in the frequency characteristics of the output stage.

THE OSCILLATOR

The secondary of the transformer feeds into the type 6C6 oscillator. The oscillation transformer consists of

98 turns of No. 26 D.C.C. enameled wire, tapped 39 turns from the end to which the cable connects. It is thoroughly shielded in a can, and is tuned by means of a 250 mmf. trimmer. Figure 2 shows all wiring in this unit.

The output of the oscillator is fed through an 80 mhy. R.F. choke, around which has been wound a coil consisting of 10 turns of No. 26 D.C.C. wire, wound between the coil and the mounting base, in the same direction as the turns of the choke.

A pair of leads are brought from this 10-turn winding, one being cut short and taped a few inches from the shield can. The other lead is made about 10 to 20 ft. long, and is wrapped around the antenna lead of the radio receiver.

ADJUSTMENTS

The oscillator may be set for any desired frequency within its range, by means of the trimmer. The desired frequency should be one which is as far as possible from that of any powerfully-received broadcasting station.

Perhaps the easiest way to adjust this frequency is to connect some input, such as a phonograph pickup or crystal microphone, to the input of the preamplifier, and to connect the output of the oscillator to the antenna of the radio set, which is tuned to the desired frequency. The trimmer on the oscillation transformer is then adjusted until a loud, clear signal is heard through the loudspeaker of the radio set.

Part II of this article will describe the construction of the optical system, the method of mounting the P.E. cell, of making the light slit, and of setting the film feed rollers.

LIST OF PARTS

Three standard 6-contact sockets;
One standard octal base socket;
One I.R.C. resistor, 1 meg., $\frac{1}{2}$ -W.;
One I.R.C. resistor, 0.5-meg., $\frac{1}{2}$ -W.;
Four I.R.C. resistors, 0.1-meg., 1 W.;
Two I.R.C. resistors, 7,500 ohms, 1 W.;
One I.R.C. resistor, 20,000 ohms, 1 W.;
One I.R.C. resistor, 2,250 ohms, 1 W.;
One I.R.C. resistor, 400 ohms, 1 W.;

One I.R.C. resistor, 0.25-meg., 1 W.;
One I.R.C. resistor, 5,000 ohms, 1 W.;
One I.R.C. resistor, 50,000 ohms, 1 W.;
One I.R.C. resistor, 2,500 ohms, 1 W.;
One I.R.C. resistor, 5 megs., 1 W.;
One Candohm line cord, 160 ohms;
One Centralab volume control, 0.5-meg.;
One padding condenser, 250 mmf.;
One R.F. choke, 80 mhy.;
One plate impedance filter choke, 22 hys.;
One audio transformer, 3:1 ratio used as output transformer;
One D.P.S.T. toggle switch;
Two 6C6 tubes;
One 25L6 tube;
One 25Z5 glass tube (a 25Z6 metal tube is shown in Figs. 1 and 2, but either is optional as both are interchangeable);
One mica condenser, 0.01-mf.;
One Cornell-Dubilier paper condenser, 1 mf., 400 V.;
One metal-cased paper condenser, 0.1-mf., 400 V.;
One Cornell-Dubilier condenser, Beaver type, 8 mf., 150 V.;
Two Cornell-Dubilier electrolytic condensers, 25 mf., 25 V.;
Two Cornell-Dubilier tubular condensers, 0.05-mf.;
One mica condenser, 250 mmf.;
Two Cornell-Dubilier condensers, Beaver type, 40 mf., 150 V.;
One Cornell-Dubilier tubular condenser, 0.1-mf., 400 V.;
Three ft. of low-capacity, shielded, rubber-covered wire (must be of low capacity);
One shield can for pre-stage 6C6;
Number 26 enameled and No. 26 D.C.C. wire;
Two grid caps;
One piece of bakelite tubing, $2\frac{1}{4}$ ins. long and 1 in. dia.;
One metal coil shield, $3\frac{1}{2}$ ins. high, 2 ins. dia.;
One metal chassis;
Four ft. shielded cable;
One male-female single-conductor mike connector.

This article has been prepared from data supplied by courtesy of Home Talkies Sound Laboratories.

SERVICING QUESTIONS & ANSWERS

UNSATISFACTORY OPERATION

(93) Roy Hutchison, Summit, Miss.

(Q.) I have in my shop a Motorola car radio model 34. The set has been operated in a car which has the positive post of the battery grounded. The set never operated very satisfactorily and a few days ago the owner brought this set to me with several condensers shorted out.

Please tell me what changes will be necessary in order to make this set play well with the chassis used as a positive circuit.

Will it be necessary to change any parts other than the electrolytic condensers?

(A.) The Motorola auto-radio receiver model 34 does not employ a synchronous vibrator, and therefore will operate without regard for car battery polarity. The defective condensers mentioned in your letter were not the result of reversed car battery polarity. We suggest that the vibrator and buffer condensers be checked carefully before installing the new electrolytic condensers.

TUNABLE HUM

(94) J. R. Knights, Sandwich, Ill.

(Q.) Perhaps you can help me with a problem I have. It is with modulation hum in a Silver A.C.-D.C. radio set manufactured by the T. R. Co., Chicago (whoever that is). This set has 1-6D6, 1-25Z5, 1-6A7, 1-75, 1-25B6G and a ballast tube.

When the plug is put into a 110-V., 60-cycle A.C. receptacle one way, there is a very bad hum on every station but none between stations. When the plug is turned half-way around in the receptacle, the hum is so bad that you cannot understand a word said on the station; still it isn't very bad between stations.

I substituted new filter condensers, tried a 0.1-mf. condenser from each side of the 110-V. line to chassis, tried 0.1-mf. from cathode to

plate of the rectifier tube. Checked all the bypass condensers and resistors, tested filter choke and speaker field for grounds but nothing seems to improve it.

I also substituted new tubes for all the old ones except the 25B6G. Voltages seem to be OK. If the antenna is disconnected or in fact anything is done that cuts out the signal, then the hum stops also.

I had a small A.C.-D.C. set of another make with the same trouble except that it worked fine when plugged into the 110-V. socket one way. If put in the other way it had a bad modulation hum.

(A.) Modulation or tunable hum, such as you describe in your letter, is a common complaint with A.C.-D.C. receivers. Most often, this trouble is caused by faulty filter condensers which have "lost" capacity or become open-circuited. In some cases, increasing the capacity of the first filter condenser to 16 or 24 mf. will overcome the difficulty. The line bypass condenser is a frequent offender. The usual position for this unit, a 0.1-mf. condenser, is from plate of the rectifier tube to "B-," or chassis. Try a 0.25-mf. condenser in severe cases.

In receivers where the tube heaters are connected in series, it is important that the most critical tube heater, the type 75 tube in your particular case, be wired nearest the side of the line to which the negative plate supply is connected. Check grid filter condensers.

It is advisable to shield all R.F. and I.F. grid

leads so that heater leads and pilot light leads will not induce a voltage in the grid leads and thus modulate the carrier wave.

Check the antenna series condenser for a short-circuited condition. A smaller capacity is often helpful.

OSCILLATION—I.F. 'SCOPE PATTERN

(96) F. E. Chapman, Hermon Pond, Maine.

(Q.1) Are there any definite tests, or indications, that can be used to determine which stage or stages of a receiver are oscillating? The distinctive "plop" is not always heard when the tube grid is touched, a microammeter in the grid circuit will usually stop oscillation, and I am not certain whether or not a milliammeter in the plate circuit will detect an oscillating screen-grid tube. I have not had much success in the use of the oscilloscope and vacuum-tube voltmeter. Perhaps the sensitivity was too low. Sometimes these oscillations occur only over a portion of the dial, which I should think would indicate a tuned stage, and sometimes only with antenna attached to the set.

Several sets have given trouble due to oscillation manifesting itself by a rapid pulsating sound from the speaker something like a *swish, swish, swish*, and which occurred only with the antenna attached to the set. The sound could be stopped by touching the R.F., mixer, or I.F. grids, but no "plop" occurred on any of them. Oscillation might take place over some portion of the dial or over the whole dial, being more pronounced at one end, and could also be stopped by detuning the I.F. amplifier. The fact that oscillation took place only with antenna connected to the set led me to suspect the R.F. stage, but I was not sure whether or not the added capacity could be reflected through a tube, the same as from one side of a transformer to

(Continued on page 364)

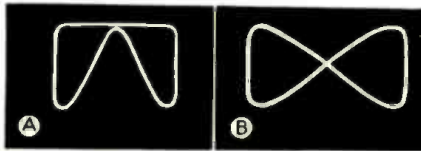

Fig. 95-2. 'Scope patterns encountered in servicing.

OPERATING NOTES

Trouble in . . .

. . . RCA T4-10

This midget set came in with a very loud hum and "hash" distortion on local stations. At first it appeared to be hum-modulated on a strong station but placing a condenser across the line did not help. Then it was noticed the volume control cut off sharply and upon opening it the element was found to be defective. A new 25,000-ohm control cured the trouble completely. The speaker, being magnetic, might have been blamed for the distortion but it really was all right.

ISAAC S. BLANDER

. . . MAJESTIC CHASSIS 200

Symptoms: Either weak or intermittently-weak. Tubes OK. Voltages and currents normal. Noise level high. Check 1st radio-frequency-return bypass. It is located on top of coil in coil can on top of chassis.

WM. IMPOLA

. . . ZENITH MODEL 807

Set dead—the 11,000-ohm section of the candohm voltage divider open, causing lack of voltage on screen-grids.

Exact replacement of candohm is recommended. It is advisable to check the 75 plate coupling condenser, a 0.02-mf. unit, for leakage.

GEORGE H. BLEEKER

. . . RCA 86-T-6

On several of these pushbutton receivers, I found that nearby broadcast transmitters caused severe crosstalk, sometimes 3 stations on 1 button setting. This interference caused "birdies" on the shortwave bands and also crosstalk when buttons were all "normal," i.e., all buttons disengaged. On a 50-foot antenna some of the nearby transmitters caused broad tuning. For instance, WCFL, 2 miles away, could not be heard on his carrier setting, but could be heard on both sides of it.

The only remedy is to shorten the antenna to 5 or 6 feet, and to connect 0.01-mf. fixed condensers across the primary of the power transformer. This eliminates all of the above trouble. With 5 or 6 feet of antenna, I still have plenty of signal pick-up, minus the irritating cross-programs.

JOHN PENAZ

. . . GENERAL ELECTRIC G-85 (1939)

The receiver would distort when tuned to resonance, but your car would necessarily serve to indicate correct tuning, for the 6U5 "magic eye" would not vary the width of its green shadow in correct accordance with the presence or non-presence of a transmitter's carrier wave.

The 2nd I.F., a 6K7, used fixed-bias, secured through a cathode resistor. The 1st I.F. (also a 6K7) was supplied A.V.C. voltage from a diode plate of the 6Q7G, as was also the grid of the 6A8C, in normal operation. The plate currents, to these two, latter tubes, did not vary.

The R.F. filter condensers were checked, no shorts. Proceeding, to the diode detector, it was found that the resistor supposed to go to the A.V.C.-controlled tubes was connected, erroneously (at the factory; it was a new set), to the

lead that connects to the power transformer center-tap.

This is shown in the diagram, Fig. 1: the resistor under discussion is called "R."

No diagram was available from the manufacturer's distributor, it's a very recent model, and for that reason it was necessary to trace the circuit, a laborious job.

WILLARD MOONEY

. . . MOTO-MASTER PLA-PAL

The volume control switch on this model is a difficult one for which to obtain a replacement. If the metal back is still good, then, by removing the rivets from it, the bakelite switch from a standard Centralab control can be bolted in place with 3/32-in. bolts.

HOWARD H. ARNOLD

. . . MOTOROLA 5-1 CHASSIS

Low volume and a crackling noise are caused by electrolytic action in the 1st I.F. transformer. Test for this by placing the primary and secondary of the coil, respectively, in series with a 6 V. battery and a headphone. A crackling noise indicates the defective part. This condition is sometimes intermittent, making it difficult to check.

. . . UNITED MOTORS NO. 364441 (Chevrolet)

Complaint: Intermittent operation—dead from 840 kc. to high end of dial.

After first checking all tubes and voltages, I found some of the sets were low on plate and screen-grid voltages of about 15 volts as rated in manufacturer's voltage chart. This trouble was due to both a high leakage in filter condensers and vibrator. But after bringing the voltages back to normal you could not get circuit to oscillate from about 840 kc., on up. Tried several new 36-type tubes (oscillator) but still no results. Replaced the 4,200-ohm resistor, 0.002-mf. con-

(Continued on page 365)

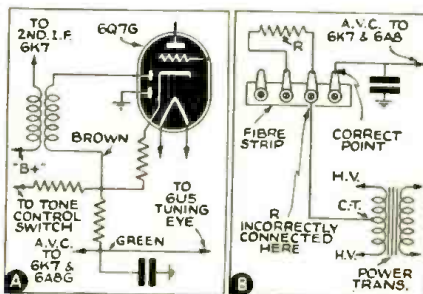

Fig. 1. Problem in a G.E. G-85 (1939).

U. S. ARMY P.A. SYSTEM HAS 1-MILE RANGE!

Quarter million people recently heard President Roosevelt over this super-power Public-Address system.

USED for the first time to carry addresses by President Roosevelt and Governor Earle, to a throng at Gettysburg battlefield estimated by Pennsylvania State Police at 250,000, a powerful mobile Public Address system built for the U. S. Army Signal Corps by the RCA Manufacturing Company was placed in service.

The system, built in a 2½-ton panel body truck to specifications supplied by the Signal Corps, consists of 6 RCA 100-watt loudspeakers each capable of directing a powerful beam of sound for distances upwards of a mile, and 2 high-fidelity theatre-type speakers permanently mounted on either side of the interior of the truck to operate through large grilles. The system is designed to operate either from an outside source of power or from a gasoline motor-driven generator mounted in the truck.

The unit successfully passed difficult tests at Fort Meyer, Virginia, before high ranking officials of the War Department. On July 3 it was first used for Public Address purposes by the President and the Governor in dedicating the Eternal Light Peace Memorial, at Gettysburg, Pa., later being utilized

(Continued on page 367)



Above—the army's super-power Public Address truck all packed for a trip.



Each loudspeaker has a 1-mile radius! Theatre-type hi-fi units in the truck service crowds of 5,000 or fewer persons. Truck has phono-radio and recording equipment.

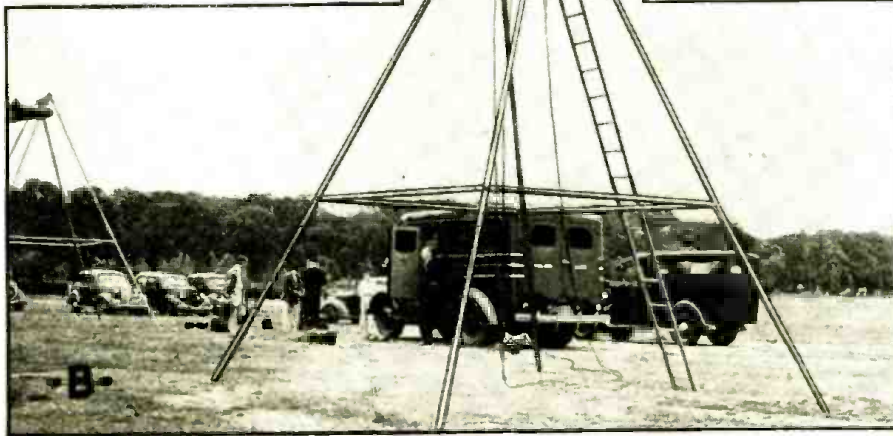

MANHOLE LOUDSPEAKERS

You plant a loudspeaker—up comes high-fidelity sound!

THE photo at A shows the installation of one of the new underground speakers in a stadium in Germany. The new speakers effect unexcelled sound distribution of great uniformity, and reproduce all low notes with high fidelity. The reason for this improvement is due largely to the large baffle area, since the entire ground of the stadium, etc., acts as baffleboard. The coverplate shown is made of cast iron which is equipped with step-proof

W. E. SHRAGE

sound openings of interesting design.

In the foreground of illustration B the pit is seen to be lined with a concrete tube into which the new type of underground speaker has been installed. In the background the grandstands of the stadium are seen. The sound distribution obtained by this type of Public Address system surpasses every other type of speaker installation and is unusually large. Another factor of interest is the

(Continued on page 359)

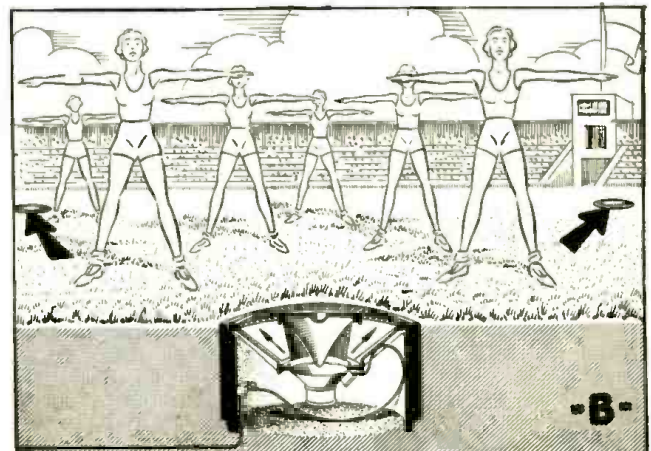
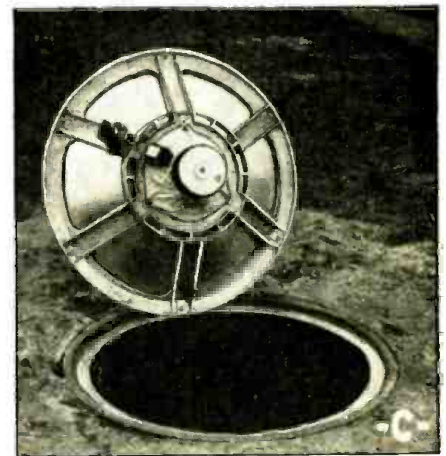

10 x 12 FOOT, 441-LINE SCAN-DISC TELEVISION!

A television engineer returns from Europe.

"GERMANY has made such rapid strides in television and is now so far ahead of other countries it would be difficult to equal the results in a short length of time," reported Marshall P. Wilder, television engineer of National Union Radio Corp., upon his return to America last month after a visit to the Berlin Radio Show (which Dr. Goebbels opened) and other points of interest in Germany and England.

Among the more interesting photos Mr. Wilder brought back with him are those we reproduce on this page. Hollywood may be able to benefit from television, if it finds a couple of the new ideas applicable. There is, for instance, the 441-line scanning system, available both in mechanical (Nipkow disc) and electronic (cathode-ray) scanning, as well as the intermediate-film pick-up equipment which photographs the scene, and develops and dries the film, in 80 seconds! (It's available in portable form, too.) In movieland, scenes could be checked on the spot, corrections made in staging, acting, lighting, etc., and a retake made—all in less time than it takes to tell about it; and where time (Continued on page 376)



Here is an unretouched photograph of a television image as it appeared on the 10 x 12 ft. screen in a recent demonstration during the Berlin Radio Exhibition. The excellent detail exhibited was accomplished by the use of 441-line fidelity and 25 pictures per second with interlaced scanning. The "secret" of how the amazing brilliance was achieved lies in the use of a "lens screen" about which little is so far known.

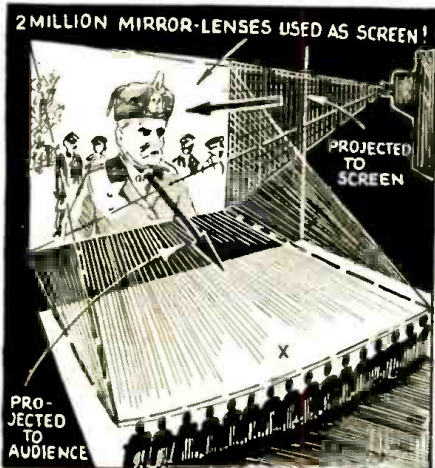

By means of 2 million lenses on a 10 x 12 ft. screen an improvement in light intensity of 30 times is obtained—here is a tip for Hollywood. The lenses act to concentrate the light into a beam (much as the spangles on a dress reflect light) 70 rows deep.

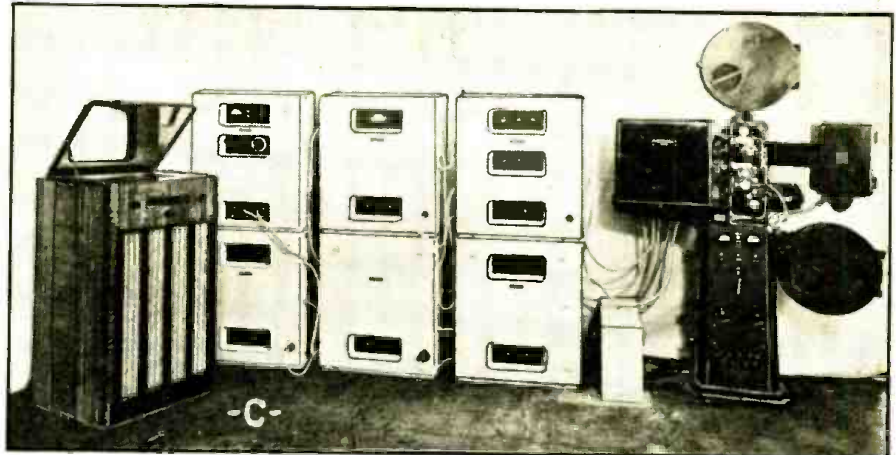

A complete film scanner including monitor is shown above. This scanner scans film electronically using a Farnsworth dissector and includes all necessary amplifiers, and blanking and sync-pulse generator which supplies a 1-V. signal from a 20-ohm source to a coaxial cable or power amplifier in a television transmitter. Like the film scanner shown below at B and D, this equipment is only for image pick-up at the studio and hence is not to be confused with the television projection equipment. Incidentally the television projector, shown for convenience in illustration as being high in the air in the drawing at left, in practice is located on the floor about at the spot marked X.

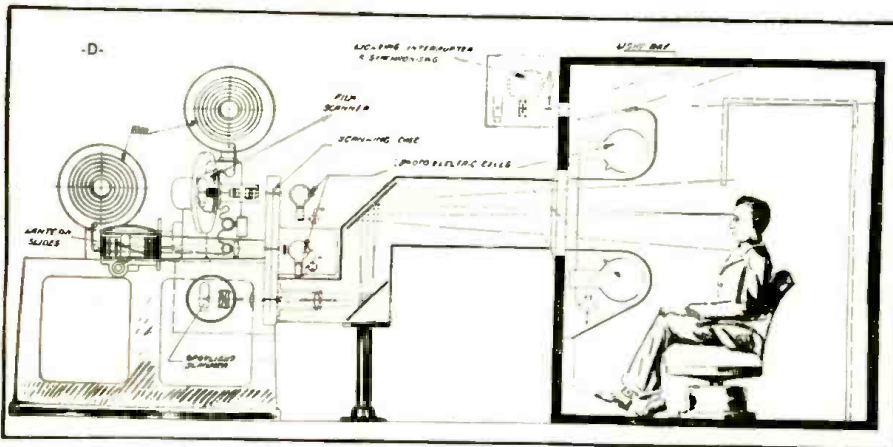

Disbelieve it if you will, but Fernseh A. G. has developed a 441-line Nipkow disc television transmitter as shown above. Not only that, but, simultaneous 4-way scanning is achieved! The Nipkow disc whirls in a vacuum at 10,000 r.p.m. Mechanical correction of the trapezoidal distortion is provided. By using 4 different quadrants of the Nipkow disc it is possible to (1) make direct pick-up, (2) scan a still picture, and (3) simultaneously or (4) independently scan 2 moving picture films. Note that this 441-line mechanical studio scanner, and the 441-line electronic studio scanner shown at C are entirely different units from the 80-second intermediate-film, combination scanner-projectors now available with 180-line fidelity.

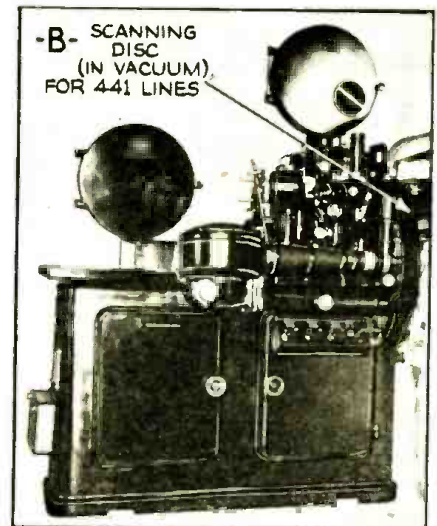

The 4-way television equipment shown in illustration D. Projection is 25 images per second, interlaced.

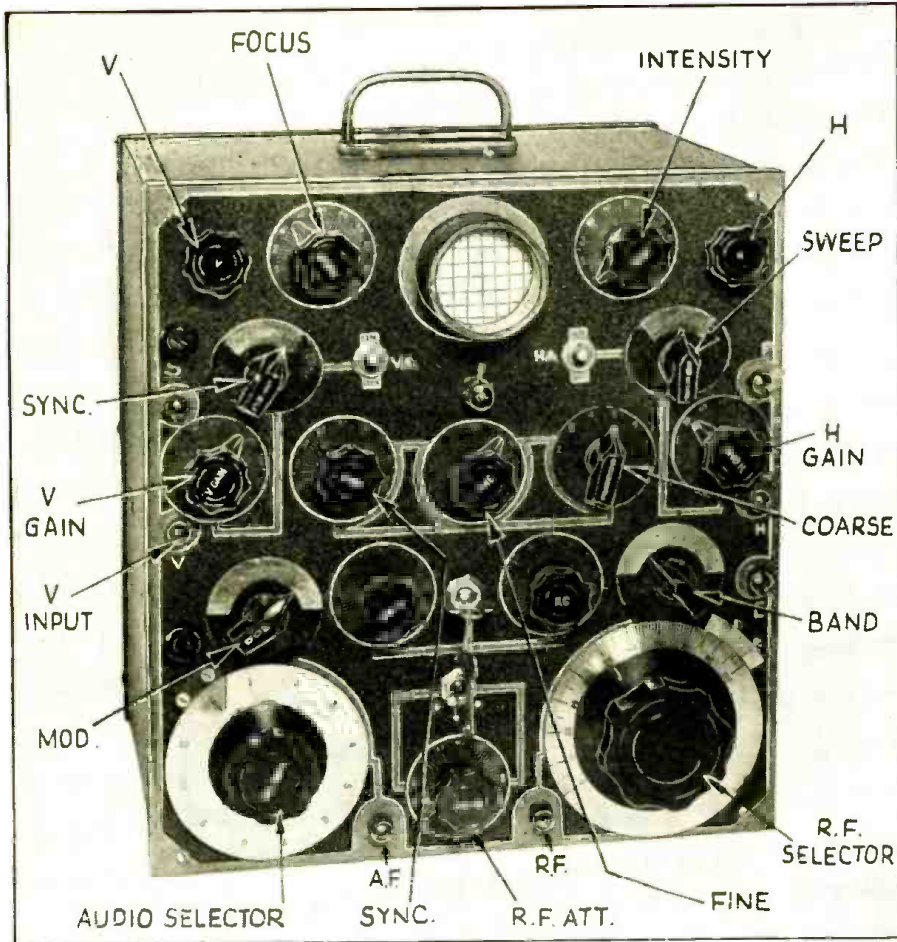

Fig. A. The complete "Super-Geno-Scope", a compact, practical instrument for the shop.

C.-R. OSCILLOGRAMS

The importance of the oscilloscope in servicing is emphasized by manufacturers in connection with their better-quality sets.

The writer, with the cooperation of the respective manufacturer's service departments, has compiled the following list of radio receiver models where oscilloscope alignment is recommended. (A more complete listing was unobtainable in the time available.) See Figs. 2 and 3, on the continuation.

RCA—1938 models: 811K (Fig. 2A), 813K (Fig. 2A), 816K (Fig. 2A), U-109 (Fig. 2A), U-106, 810K, 810K1, 810T, 911K, 910KG, U-126, U-128, 99K, 99T, 98K, 1936-7: All models from 7 tubes and up. Also early receivers that have a flat-top characteristic.

GENERAL ELECTRIC—Models: E155, 126, 129, F107 (Figs. 2A and 2D), F96 (Figs. 2A and 2C), F70, F75, F74, F77, E105, 101, F135 (Fig. 2A), G105 (Fig. 2A), F80 (Fig. 2B), F85, F81, F86, F63, F65, F66, FD62, FD625, F96.

STROMBERG-CARLSON—It is our opinion that our receivers should not be aligned using an oscilloscope but the alignment should be checked with the oscilloscope, after it has been made using an output meter.

After alignment, as instructed in the Engineering Data Sheet, all Stromberg-Carlson High-Fidelity receivers, when considered in terms of the band-spread of the I.F. system, will show oscillograms similar to those shown in Figs. 3A, 3B and 3C.

Figure 3A shows the approx. shape of the curve with the high-fidelity control in normal position; Fig. 3B, approx. shape with the hi-fi control operated part-way on; and Fig. 3C, approx. shape with the control full-on.

PHILCO RADIO AND TELEVISION CORP.—Inasmuch as Philco has always specified the "signal generator and output meter" method of alignment, regrets that oscilloscopic data are not available for the alignment of their receivers. The local service dept. recommends the use of the oscilloscope on the Mystic Control receivers models 116 RX, 55 RX.

EMERSON RADIO—Models: A 11 fairly flat, D, V, X, AB, 8R, BS, A 8.

CROSLEY RADIO—Models: 1216, 1516, 1316, 1116, 2616, 1336, and others.

ZENITH RADIO—Admitting the usefulness and time-saving ability of the oscilloscope, Zenith Radio claims that an oscilloscope does not provide any better alignment of their chassis than the "signal generator and output meter" method.

MAKING A SERVICEMAN'S TEST UNIT THE "SUPER-GENO-SCOPE"

Here in compact, portable form is a combined oscilloscope, and R.F., I.F., A.F., and modulated (and wobbled) -R.F. and -I.F. oscillator, complete with power supplies. This unit permits visual analysis of any radio set's R.F., I.F., and A.F. circuits.

PART I

CANIO MAGGIO

THE Super-Geno-Scope is a combination of several essential service instruments in one.

It consists of:

- (1) An oscilloscope, complete in every detail.
- (2) A radio-frequency fixed oscillator.
- (3) A radio-frequency variable oscillator.
- (4) A radio-frequency wobblator or modulator.
- (5) A variable audio frequency oscillator.

The various units are divided into 2 groups. Group one is the oscilloscope (Scope) and the second group includes the other units from 2-5 (Super-Geno). Both groups have individual power supplies; the reason being to maintain complete independence of each other, so

that the manipulation of one unit does not interfere with the operation of the other. It is also a more economical arrangement since the cost of the many extra filters for smoothing and stabilizing the voltages in a common power supply would exceed that of a separate power supply.

The case housing the two units measures only 11 x 12 x 8 ins.

The Super-Geno-Scope is self-contained (see Fig. A), there being no external connections, or units necessary to its operation. All diagnoses are performed by the manipulation of the proper controls on the front panel. The Scope incorporates a 2-in. cathode-ray tube.

Referring to the schematic wiring diagram (Fig. 1), the oscilloscope unit consists of a cathode-ray tube, timing

axis oscillator, 2 single stages of resistance-inductance-capacity coupled audio amplifiers and a full-wave balanced power supply.

Now let us analyze the oscilloscope portion of this compact service unit.

THE SCOPE UNIT

The vertical amplifier using the 6J7 (V1) metal tube can be cut in or out of the vertical circuit or in other words the input circuit (J1) can be fed directly to the grid of the vertical amplifier tube or to D3 of the cathode-ray tube (Sw.1). In each case there is a condenser in the input circuit (C10-C16).

The horizontal amplifier using the 6J7 (V4) metal tube is similar to the vertical amplifier, likewise the input circuit can be connected to either the

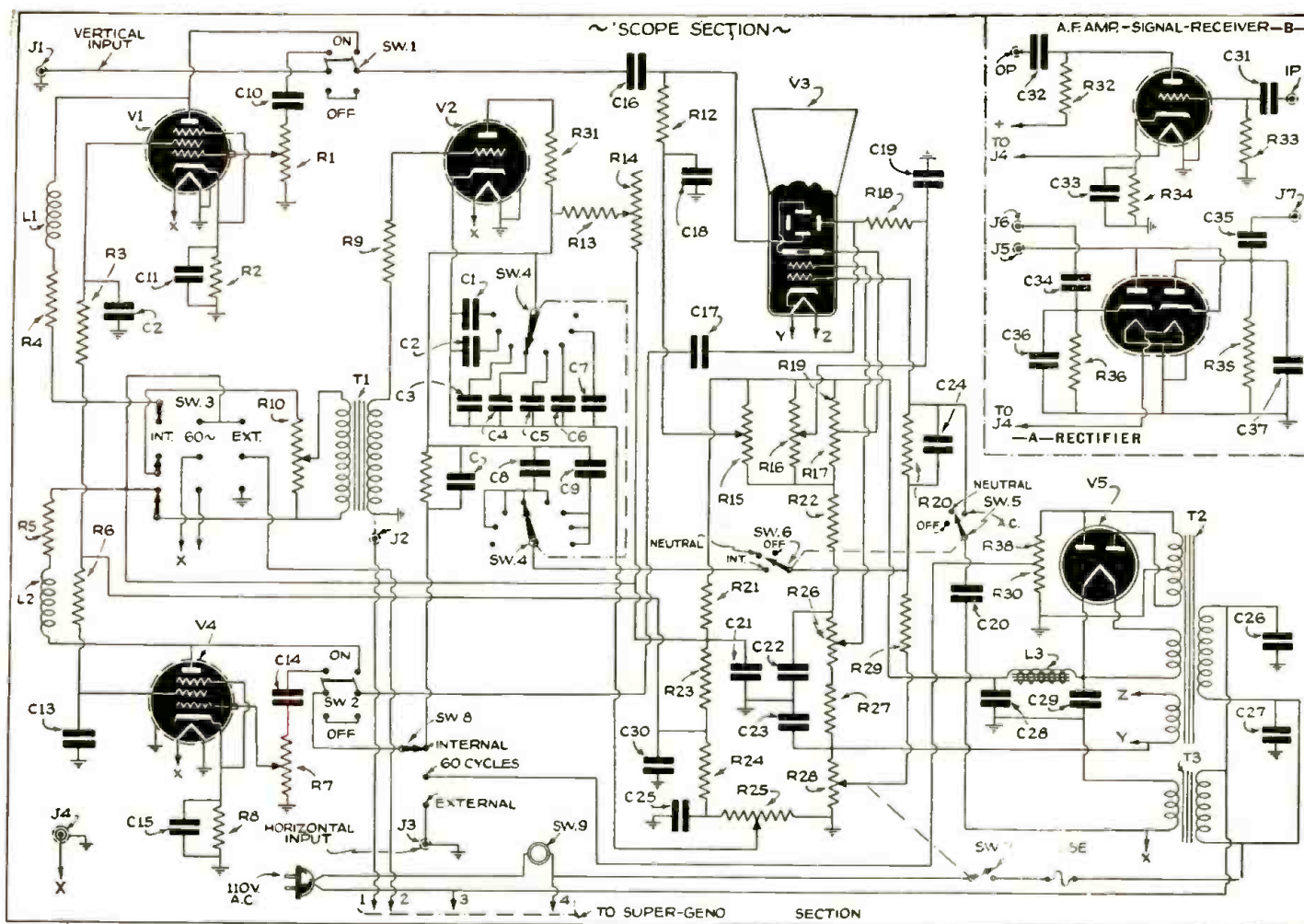

Fig. 1. Schematic diagram of the oscilloscope section of the "Super-Geno-Scope" test unit.

CONDENSERS
 C—50 mmf.
 C1—0.25-mf.
 C2—0.1-mf.
 C3—0.03-mf.
 C4—0.007-mf.
 C5—0.002-mf.
 C6—500 mmf.
 C7—100 mmf.
 C8—0.001-mf.
 C9—150 mmf.

C10—0.1-mf.
 C11—0.005-mf.
 C12—0.25-mf.
 C13—0.25-mf.
 C14—0.1-mf.
 C15—0.005-mf.
 C16—0.1-mf.
 C17—0.1-mf.
 C18—0.01-mf.
 C19—0.01-mf.
 C20—0.1-mf.

C21—0.25-mf.
 C22—0.25-mf.
 C23—5 mf.
 C24—300 mmf.
 C25—10 mf.
 C26—0.05-mf.
 C27—0.05-mf.
 C28—8 mf.
 C29—8 mf.
 C30—4 mf.
 C31—0.05-mf.

RESISTORS
 R1—0.5-meg.
 R2—1,000 ohms
 R3—0.1-meg.

R4—0.15-meg.
 R5—0.15-meg.
 R6—0.1-meg.
 R7—0.5-meg.
 R8—1,000 ohms
 R9—11,000 ohms
 R10—4,000 ohms
 R11—0.25-meg.
 R12—2 megs.
 R13—0.25-meg.
 R14—4 megs.

R15—0.5-meg.
 R16—0.5-meg.
 R17—30,000 ohms
 R18—2 megs.
 R19—30,000 ohms
 R20—0.5-meg.
 R21—20,000 ohms
 R22—0.124-meg.
 R23—65,000 ohms
 R24—20,000 ohms
 R25—3,000 ohms

R26—50,000 ohms
 R27—30,000 ohms
 R28—25,000 ohms
 R29—25,000 ohms
 R30—0.1-meg.
 R31—300 ohms
 R32—0.124-meg.
 R33—0.5-meg.
 R34—1,000 ohms
 R35—0.5-meg.
 R36—0.5-meg.

grid of the amplifier tube or D1 of the cathode-ray tube (J3-Sw.2-C14-C17).

The gain of these amplifiers is approximately 40 and through special circuit design the frequency is substantially flat from 20-90,000 cycles. The similarity of the 2 amplifiers and their wide frequency range, make the instrument ideally suited to a wide range of diagnoses.

The purpose of these amplifiers, like other amplifiers, is to amplify the input signal under observation (V1), and to amplify the time sweep signal voltage (V4) so as to obtain a sizeable image.

The time axis oscillator is provided for the horizontal sweep so that a wave-shape may be shown plotted against a linear time scale. The oscillator employs the new 884 gaseous discharge tube with an octal base and a filament voltage rating the same as the amplifier tubes. Of course this is advantageous in that a common filament voltage can be used for the amplifiers and oscillator. The frequency range is from 15-25,000 cycles per second covered in 8 steps (as determined by

switch Sw.4), and a continuous coverage is obtained by means of a variable resistor (R14).

For tests wherein a sinusoidal time axis is desired, means are provided to connect the horizontal time input to a 60-cycle wave. If any other time axis wave-shape is desired it need only be connected to the horizontal external input.

Synchronizing pulse is available either internally, 60-cycle or externally. The internal synchronization is accomplished by feeding part of the signal voltage under observation to the time axis oscillator. The 60-cycle synchronization is also internally connected.

LAYOUT

In the design and construction of the oscilloscope certain preventative measures are taken principally in the layout of the necessary parts around the cathode-ray tube. It is important that magnetic fields from transformers and chokes be isolated (kept at a distance) from the deflecting plates. If a magnetic field from a power transformer is near the

deflecting plates of the cathode-ray tube it would be almost impossible to obtain a spot or image on the screen.

The amplifier circuits or the signal conducting circuits are to be constructed as compactly as possible, so that the wiring between the input circuit, tube selector switches and to the deflecting plates is as direct as possible. These preventative measures are necessitated by the wide frequency range of the amplifiers.

In addition the Scope is provided with a balanced full-wave rectifier (detector) 6H6. With an A.C. voltage at input J5, the resulting pulsating direct current has as many rises and falls of current as the alternating input has alternations, this being double the number of cycles. Output terminals J6 and J7 are opposite in phase. See Fig. 1A.

Also when the input voltage of the 'scope is too small or the audio oscillator output voltage is too small for the type of service desired, an external amplifier unit is provided (6C5). See Fig. 1B.

The filament connection for these
 (Continued on page 376)

"CASH REGISTER" TUBE TESTER

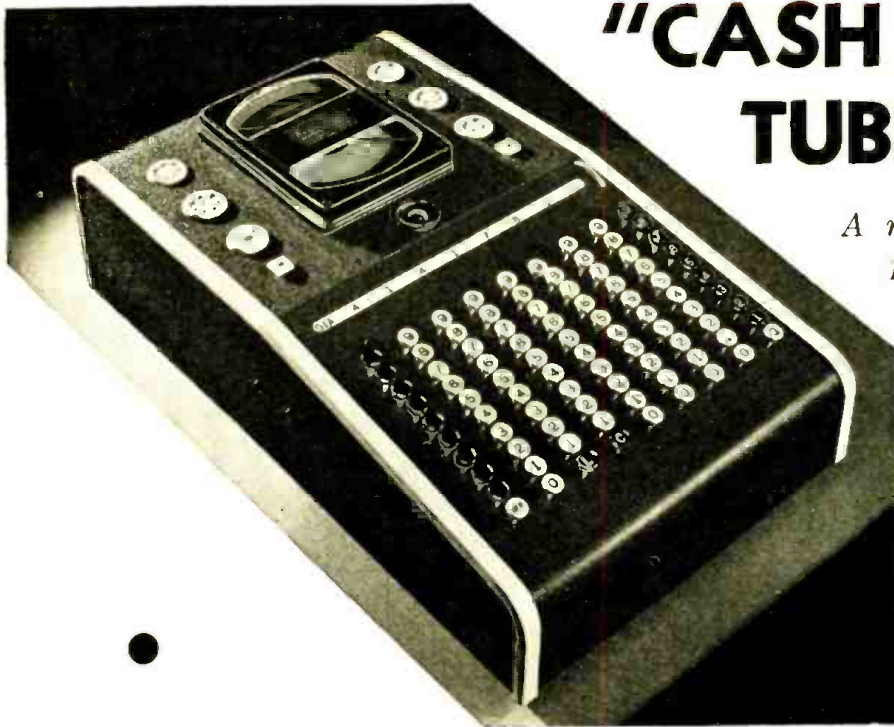

A new patented circuit utilizing 90 pushbuttons makes possible over 20 million possible settings. An 11-foot rotor chart lists settings for about 400 tubes.

SAMUEL C. MILBOURNE

the roll chart so that each number was directly above the corresponding numbered pushbutton which was to be depressed in each row, the Supreme "Zephyr" (shown in the heading illustration) allows both engineer and novice to secure equally dependable and accurate results.

ANY tube tester should be designed for (1) accuracy, (2) flexibility, (3) speed, (4) complete coverage of existing receiving tube types, (5) reasonable insurance against obsolescence, and (6) simplicity of operation.

It has long been the desire of tube tester engineers to design a tube tester

which even a child could operate. This means a design which results in the maximum of simplicity without sacrificing accuracy one bit.

By using pushbutton switches in conjunction with a roll chart, Supreme engineers were the first to attain this goal. By assigning a series of numbers to each tube type and placing these numbers on

USES OF THE BUTTONS

Through the use of pushbutton selector switches and a modern, trouble-free, accurate tube-testing circuit, any one can test all types of radio tubes for shorted, leaky or open elements as well as cathode electron flow in both single- and multi-section type tubes. In short, the pushbutton tube tester will com-

(Continued on page 379)

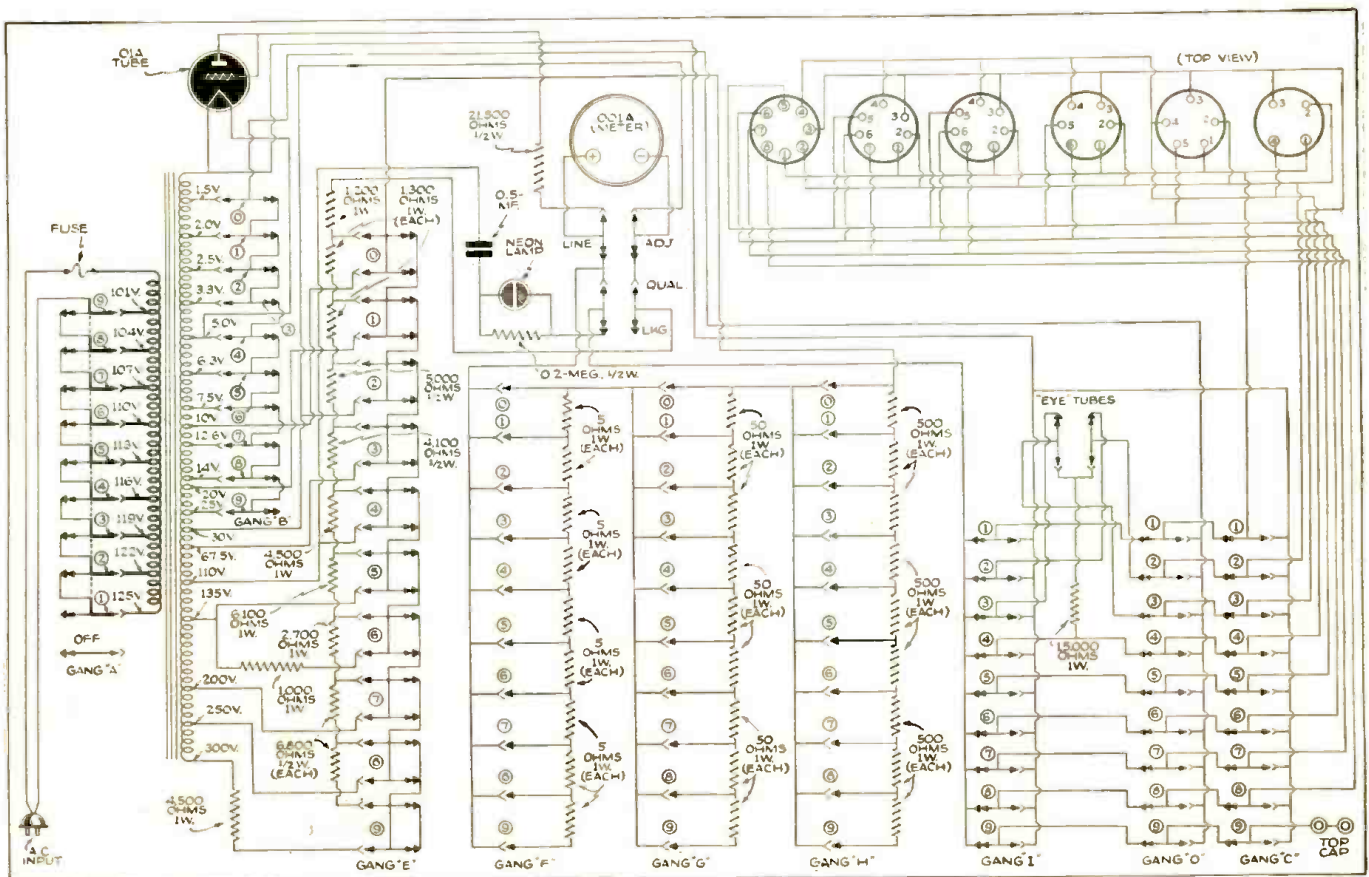

Fig. 1. Schematic diagram of the "Cash Register" tube tester which is so simple to operate that even the customer can test his own tubes.

NOVEL IDEAS IN RADIO SETS

Refreshing, indeed, are the cabinets of 2 recently-introduced radio receivers; and 2 others offer new circuit and tube arrangements worthy of special mention.



Fig. A. Smug Charlie McCarthy sells radio sets for Majestic merely by sitting on one of their models. The set is a 6-tube A.C.-D.C. superheterodyne.



Fig. B. Snow White and her Seven Dwarfs in bas-relief is Emerson's contribution to juveniles' radio.



Fig. C. Crosley's "Vanity" radio set can be placed either as shown or with the pushbuttons on top.

CHARLIE McCARTHY

TOP-HATTED, white-tied Charlie McCarthy, salesman de luxe, last month entered a new field of endeavor, wherein he lends his presence to the promotion of a radio manufacturer's new product.

Complete with monocle and stick, Charlie has been incorporated into the handsome cabinet of the new Majestic-Charlie McCarthy radio set (see Fig. A). first model in Majestic Radio and Television Corp.'s 1939 line. A life-like reproduction, Charlie is seated on a ledge before the loudspeaker section of the set, a 6-tube A.C.-D.C. superheterodyne table model only 5½ ins. wide. The circuit is shown in Fig. 1; at A, chassis No. 1, and at B, chassis No. 2. Wavelength range is 535 to 1,750 kc. Output is 2 watts.

To complete the Charlie McCarthy tie-in, the manufacturer released to the radio trade an announcement regarding the appointment of Charlie McCarthy as "Sales Manager" and Edgar Bergen as "Assistant Sales Manager" for the Majestic Radio organization.

Charlie will be shown with his new radio set in 7,800 theatres throughout the country that will feature a display of the Majestic-Charlie McCarthy Radio in connection with Universal's new production, "A Letter of Introduction," starring Charlie McCarthy, Edgar Bergen and a galaxy of other Hollywood stars.

SNOW WHITE AND DWARFS

ONE of the most interesting and attractive radio designs to be produced this year is Emerson Radio Co.'s

"SNOW WHITE" model shown in Fig. B.

The set, which is 7¼ ins. wide, plays on either A.C. or D.C. and features an audio overload control and built-in antenna. The famous characters (Snow White and all 7 dwarfs), on the set in bas-relief, are in full natural color. The set's T.R.F. circuit (model Q157 chassis) is shown in Fig. 2. Frequency range is 540 to 1,725 kc. Output is 2½ watts.

CROSLY "VANITY"

A QUADRUPLER of features accent Crosley Radio Corp.'s "Vanity" radio set, first offering in the 1939 line, as illustrated in Figs. C and D (photos), and Figs. 3 (circuit) and 4 (tuning mechanism). Case is Plaskon-molded, in old-ivory, brown or black finish.

Feature No. 1 is the "double-tilt" design of the cabinet; use it as a bookend, with the pushbuttons on top, or as a "regular" set, with the buttons operated

(Continued on page 366)

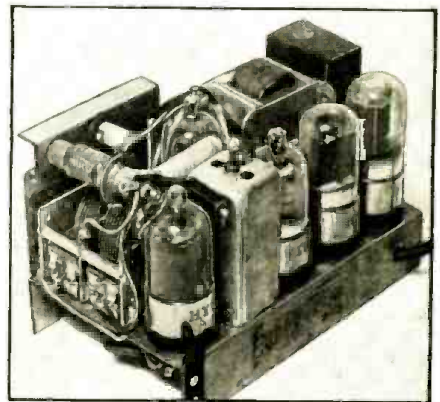

Fig. E. The "Tom Thumb" superhet. radio is the first commercial set to employ the new, small-size "bantam" tubes. Note the compactness of the chassis.

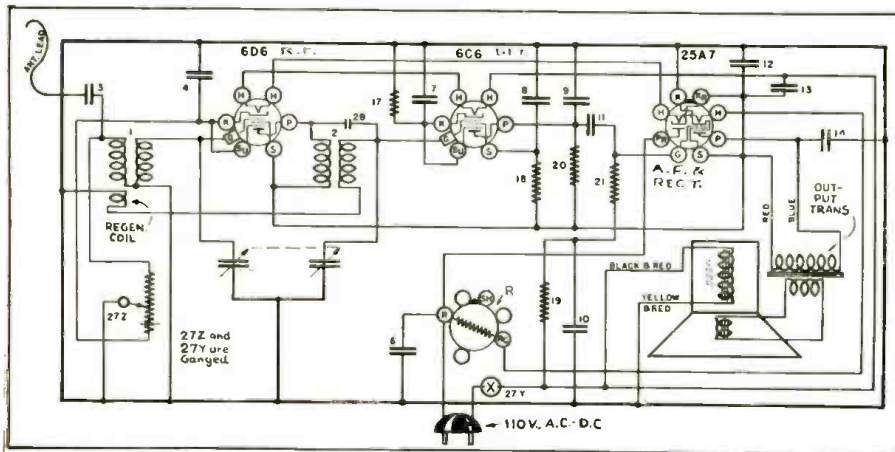

Fig. 3. Schematic diagram of Crosley receiver. Note use of regeneration in R.F. stage!

- | | | | |
|--------------------|--------------|-------------------|---------------------|
| CONDENSERS: | C9—100 mmf. | C28—7-10 mmf. | R20—0.5-meg. |
| C3—0.02 mf. | C10—0.25-mf. | | R21—0.3-meg. |
| C4—0.02-mf. | C11—0.02-mf. | RESISTORS: | 27Z—volume control. |
| C6—0.05-mf. | C12—16 mf. | R17—25,000 ohms | 40,000 ohms |
| C7—0.25-mf. | C13—16 mf. | R18—2.5 megs. | R—ballast tube |
| C8—0.02-mf. | C14—0.02-mf. | R19—0.2-meg. | |

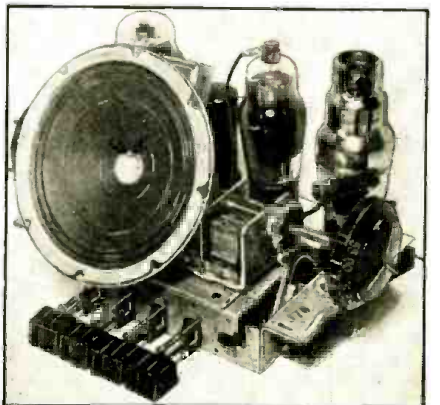

Fig. D. The Crosley "Vanity" chassis showing the mechanical pushbutton mechanism.

EXPERIMENTS WITH

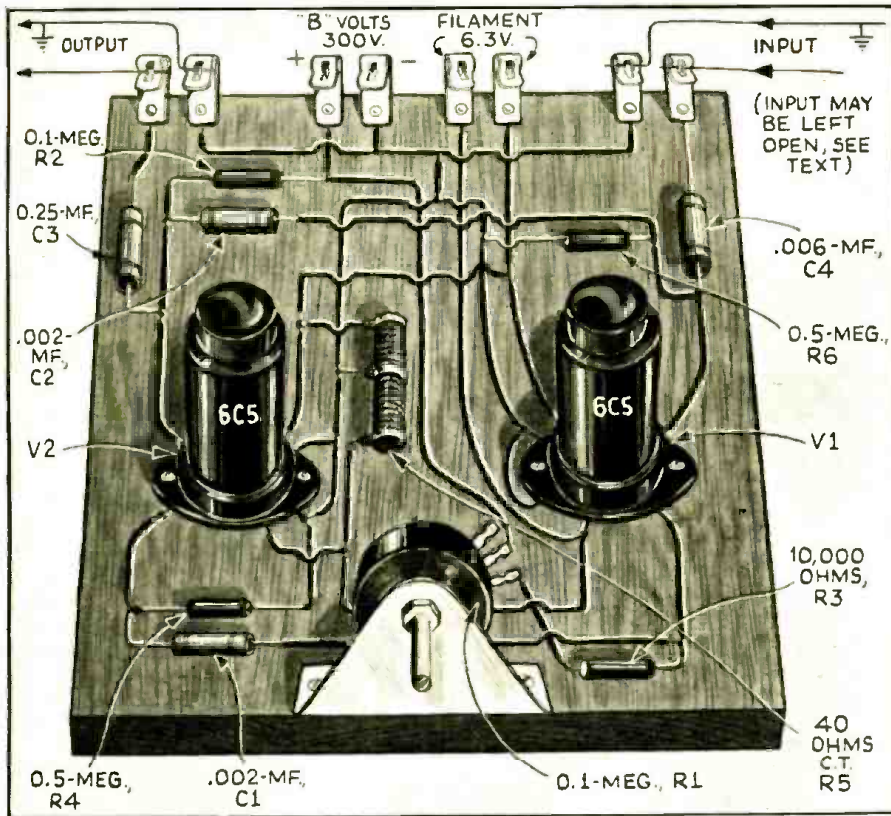

Fig. A. Pictorial diagram of completed experimental multivibrator, with all components spotted in place on a breadboard.

Here's the A-B-C of Multivibrators, and their possible use in described, by an author whose

CHARLES

also be used as an A.F. test oscillator, harmonic generator, harmonic synchronizer and as mentioned previously, sub-multiple generator.

BASIC CIRCUIT

A fundamental schematic circuit of the multivibrator is shown in Fig. 1B, a study of which will show that the phase shift occurring in both tubes is 360 degrees, or that the output voltage of the second tube is always in phase with the input voltage of the first tube.

Oscillations are started in the following manner: when the cathodes of both tubes have reached operating temperature, any infinitesimal voltage applied to either V1 or V2 grid (assume a positive pulse on grid of V1) will cause this voltage to be amplified and reappear at the grid of the first tube, to be re-amplified. This action is almost instantaneous and is repeated over and over, so that the grid voltage of V1 rises suddenly to a positive value while the grid voltage of V2 becomes more negative than cut-off. At this point amplification ceases and for a fraction of a second one tube is drawing a heavy plate current while the other tube takes no plate current at all.

This condition is momentary, because leakage through the grid resistors gradually brings the grid voltages back to normal, almost to the point where amplification is possible, whereupon the cycle is started over again.

The oscillation frequency is determined primarily by the grid leak resistance and grid capacity, but it is also affected by other circuit constants, operating voltages and tube characteristics. The approximate frequency of oscillation is given as:

THE following experiments were conducted purely to acquaint *Radio-Craft* readers with some of the possible applications of multivibrators.

By definition, the Multivibrator, or relaxation oscillator, is a 2-stage resistance-capacity coupled amplifier in which the voltage developed by the output of the second tube is applied to the input of the first tube, as shown theoretically in Fig. 1A.

USES

There are numerous practical uses to which the multivibrator may be put. First, and probably most important, is its adaptability as a sweep voltage generator in television receivers. Two such

sweeps are required in modern television receivers, one operating at about 13,000 cycles per second horizontally, while the other operates at 60 cycles per second vertically. The fact that these sweeps can be synchronized exactly (and easily) with the transmitted pulse, accounts for their increasing popularity among television researchers.

Another important application of the multivibrator is found in its use as an external or internal sweep for service oscilloscopes. Some of the uses perhaps less important, but just as practical, would be as an audio modulator for signal generators, or as a flat-top wave source for testing frequency characteristics of A.F. amplifiers. The multivibrator can

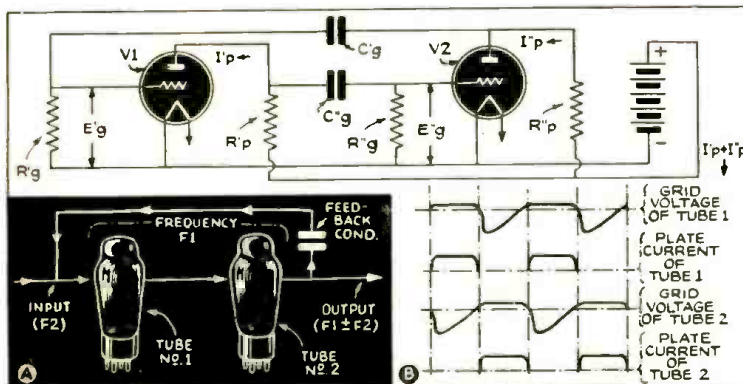

Fig. 1. Fundamental schematic and (A) theoretical circuits.

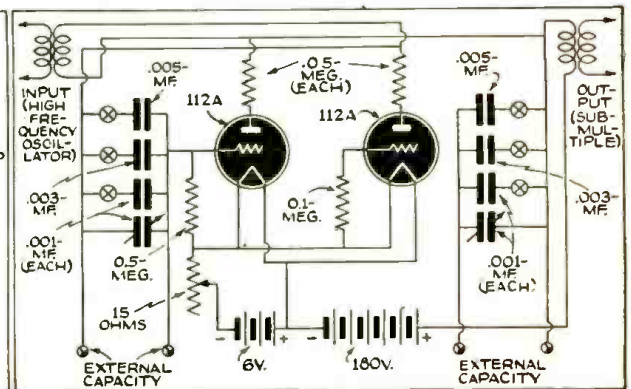

Fig. 2. Producing subharmonics of the injected frequency.

MULTIVIBRATORS

brators. Basic circuits are ana-
servicing and in television are
lucid articles make easy reading.

SICURANZA

$$f = \frac{1}{R1 \times C1 + R2 \times C2}$$

in which R1 and R2 are the plate load resistances in megohms, and C1, C2 are the grid capacities in microfarads. The result is given in fractional parts of one second.

The multivibrator can be adjusted to oscillate at frequencies as low as 1 cycle per minute, up to as high as several hundred thousand cycles per second, furthermore the generated wave is very rich in harmonics and the frequency of oscillation is readily controlled.

Injection of an alternating voltage into the input circuit tends to cause the multivibrator to adjust itself to a frequency that is a multiple of the injected frequency. In this way it is possible to produce a subharmonic of the injected frequency. An experimental setup for producing sub-multiple frequencies is shown in Fig. 2.

EXPERIMENTAL UNIT

The experimental unit shown schematically in Fig. 3 and illustrated pictorially in Fig. A was built from parts which are usually found in an experimenter's treasure box (we don't like the word "junk-box"). However it is not necessary to use metal tubes, nor a power pack as shown. The 8-terminal strip may be substituted by binding posts or fahnestock clips. Changing any of the circuit constants will result in a change of frequency. The variable control was included as a convenient method of changing frequency from 250 to 450 c.p.s. in the experimental model, but may be replaced by a fixed resistor for fixed-frequency work. The operating voltage out of the power pack shown is 400 volts, but lower voltages may be

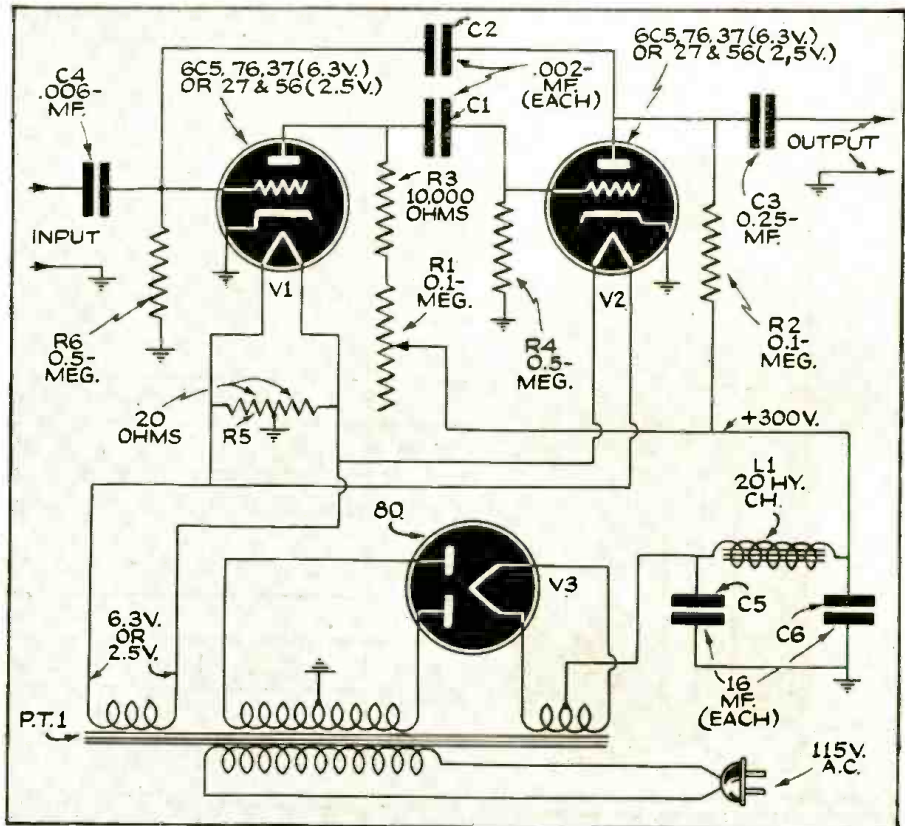

Fig. 3. Complete diagram of experimental multivibrator (see Fig. A) and its power supply.

employed, as from a "B"-eliminator or batteries. Construction details are omitted because of the obvious simplicity of the unit.

An oscilloscopic study of the multivibrator waveform was undertaken and some of the simpler waveforms are shown in Fig. 4. In Fig. 4A, is seen the crenellated wave obtained with optimum load and open input. In Fig. 4B, the waveform loses its flat-top because of the low output load and open input. In Fig. 4C, we injected varying amounts of 60-cycle sine-wave voltage into the input. The waveform clearly shows the 60-cycle interpolation and also shows that the sine wave has assumed the same form as the multivibrator wave,

(Continued on page 383)

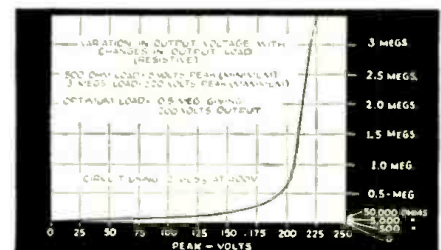

Fig. 5. V.-T.V.M. check of voltage variation.

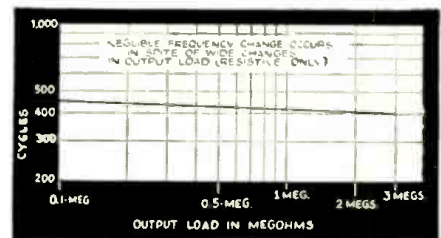

Fig. 6. V.-T.V.M. check of frequency variation.

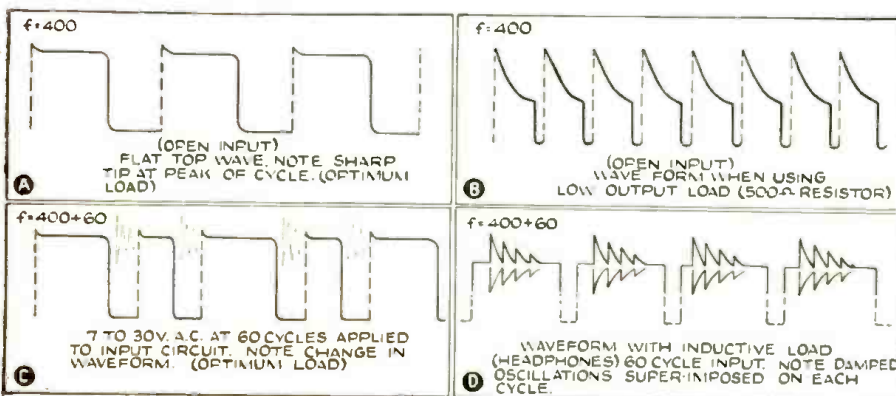

Fig. 4. Waveforms of multivibrator under test conditions.

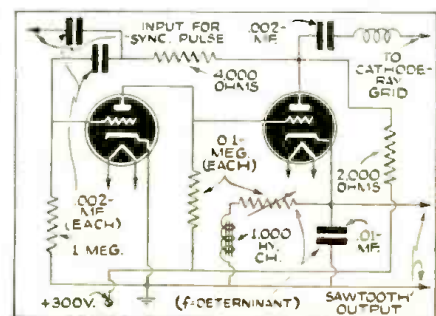
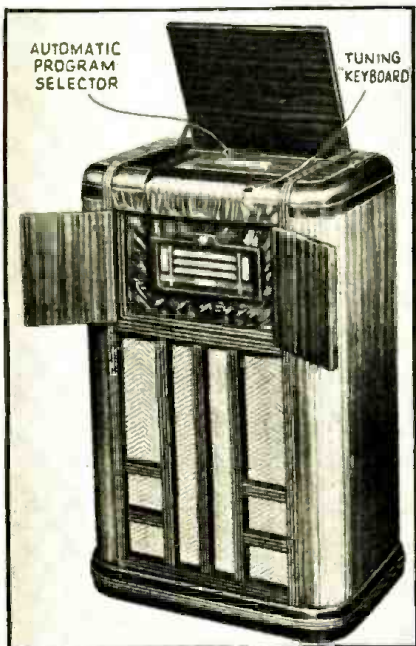

Fig. 7. Vibrator for television sweep.

GENERAL ELECTRIC MODELS G-105 AND G-106

(See Data Sheet 242 for circuit diagram.)

10-Tube Superhet.; 3-Bands (540-1,575 kc.; 1,575-5,700 kc.; 5,700-18,000 kc.); "Beam-a-Scope" built-in antenna; 13-Station Touch-Tuning System; Push-Pull Output; A.V.C.; Power Output (max.) 13 W.; Automatic (time clock) Program Selection (Model G-106 only)



General Electric Model G-106 receiver featuring automatic program selection, Beam-a-Scope antenna, and touch-tuning. The pushbuttons are in the form of piano keys.

SOCKET VOLTAGES

Tube No.	Plate to Ground Volts D.C.	Screen-Grid	Cathode to Ground Volts D.C.	Cathode Current Ma.
		to Ground Volts D.C.		
6K7 R.F. Conv.	215	95	2.6	7.5
6A8 Osc.	215	85	2.7	9.0
6K7 I.F.	135	—	—	—
6H6	215	95	2.6	7.5
6F5	150*	—	0	1.0
6J5G	85*	—	0	2.0
6V6G	280	290	17.5	40 ea.
6U5	220	—	—	0.5
5U4G	Plate to Plate 680 R.M.S.	350	120	—

6F5 Bias Supply Voltage—1.2 Volts
 6J5G Bias Supply Voltage—3.5 Volts
 A.C. Heater Volts—6.4 (except 5U4G—5.1 V.)
 A.C. line voltage—120. No signal input—1,000 ohms/volt meter—dial pointer at 530 kc. on broadcast band.

*Measured on 500-volt scale.

TOUCH-TUNING

Figure 1 shows a simplified schematic of the control circuit and the following cycle of operation may be traced very easily. When a key is depressed, it completes the 23-volt circuit through the button making contact with the contact segment (CT) and energizes one winding of the motor. The other winding on the motor is energized through the condenser C51. The direction of rotation of the motor is

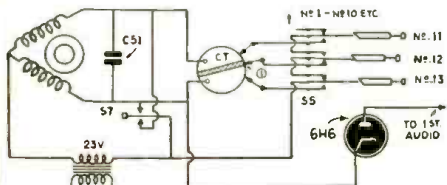

Fig. 1. Schematic of touch-tuning system.

ALIGNMENT PROCEDURE

I.F. Alignment with Oscilloscope*

Band Switch Setting	Input Frequency	Tone Control Position	Point of Input	Trimmer	Comments
1. Band B	455 K.C. and 30 K.C. Sweep	Normal	I.F. 6K7 Grid	2nd I.F. Sec. 2nd I.F. Pri.	Condenser gang at minimum capacity—vertical input to ground and junction at R-25, R-12, and R-17. Adjust trimmers in order mentioned for a single curve of maximum amplitude. The resulting curve on the "normal" position is shown in Fig. 2A. The expanded curve taken with tone control at "Treble I" is shown in Fig. 2B.
2. Band B	455 K.C. and 30 K.C. Sweep	Treble I	Converter 6A8 Grid	1st I.F. Sec. 1st I.F. Pri.	
3. Band B	455 K.C. and 30 K.C. Sweep	Normal	Converter 6A8 Grid	1st I.F. Tertiary	
4. Band B	455 K.C. and 30 K.C. Sweep	Normal	Converter 6A8 Grid	All I.F. Trimmers	

I.F. Alignment with Output Meter*

Band Switch Setting	Input Frequency	Tone Control Position	Point of Input	Trimmer	Comments
1. Band B	455 K.C. modulated	Normal	I.F. 6K7 Grid	2nd I.F. Sec. 2nd I.F. Pri.	Condenser gang at minimum capacity—output meter connected across voice coil—volume control at maximum—input as low as practical. Adjust all trimmers in order listed for maximum output. Note:—Do not attempt alignment in the expanded position.
2. Band B	455 K.C. modulated	Normal	Converter 6A8 Grid	1st I.F. Sec. 1st I.F. Pri. 1st I.F. Tertiary	
3. Band B	455 K.C. modulated	Normal	Converter 6A8 Grid	All I.F. Trimmers	

R.F. Alignment**

Band Switch Setting	Input Frequency	Tone Control Position	Point of Input	Trimmer	Comments
1. Band B					Mechanically adjust dial pointer to first line at left-hand end of dial scale with condenser gang fully meshed.
2. Band B	1500 K.C. modulated	Bass	Antenna Post	Osc. (C-5) R.F. (C-17) Ant. (C-2)	Connect output meter across voice coil—antenna switch turned to counter-clockwise position. Adjust trimmers in order listed for maximum output.
3. Band B	580 K.C. modulated	Bass	Antenna Post	Osc. Padder (C-8)	Adjust padder for maximum output in vicinity of 580 K.C. while rocking gang condenser.
4. Band B	1500 K.C. modulated				
5. Band C	5500 K.C. modulated	Bass	Antenna Post	Osc. (C-4)	Adjust trimmer for greatest output with dial pointer at 5500 K.C.
6. Band D	18.0 M.C. modulated	Bass	Antenna Post	Osc. (C-3) R.F. (C-16) Ant. (C-1)	Peak C16 and C1 while rocking gang condenser. The image of any signal on the D band should be 910 K.C. below input signal. Example: 15 M.C. image 14.09 M.C.
7. Band B	1500 K.C. modulated	Bass	Antenna Post	Beam-a-scope (C-54)	Turn antenna switch to clockwise position, align Beam-a-scope trimmer for maximum output.

* Use "dummy" antenna consisting of 0.05-mfd. condenser between signal generator and point of input.
 ** Use "dummy" antenna consisting of 250 mmf. condenser in series with 200-ohm resistance between the signal generator and the point of input.

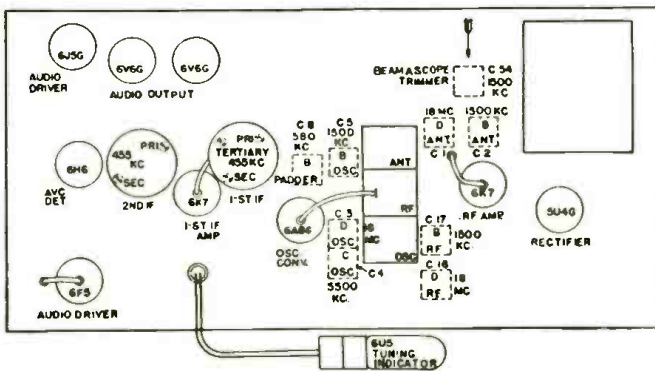

Fig. 3. Location of tubes and trimmers.

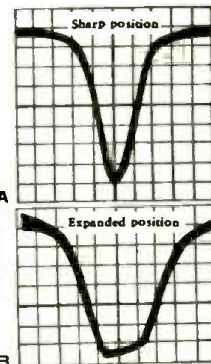

Fig. 2. Visual i.f. curves.

dependent upon whichever half of the contact segment (CT) that the station button first energizes. When voltage is applied to the motor, the rotor is pulled further into motor field, and engages its rubber cone hub with the dial drive wheel which in turn rotates the gang condenser and contact segment (CT). This operation continues until the insulated segment (1) breaks the station button circuit to the contact segment and removes voltage from the motor. The inertia in the tuning system drives the insulated segment past the station button and makes contact with the other half of the contact segment. This energizes the other winding of the motor and causes the motor to reverse. The brake on the dial drive wheel does not allow the tuning

system to store up enough inertia to go past this insulated strip on the reversal of the motor and thus allows the station button to come to rest on the narrow insulated segment, thus stopping the tuning operation to this pre-set position.

The motor scan switch S7 is incorporated to allow finger-tip control of the motor drive. Normally, the switch contacts are open and control of the motor is had by closing either of the two sides of the switch dependent upon the direction of travel desired.

On 25-cycle receivers, 2 motor condensers are used to obtain the necessary phase shift. The brake pad tension should be re-adjusted when operating a 25-cycle receiver on a 60-cycle circuit.

GENERAL ELECTRIC MODELS G-105 AND G-106 (See Data Sheet 241 for other information.)

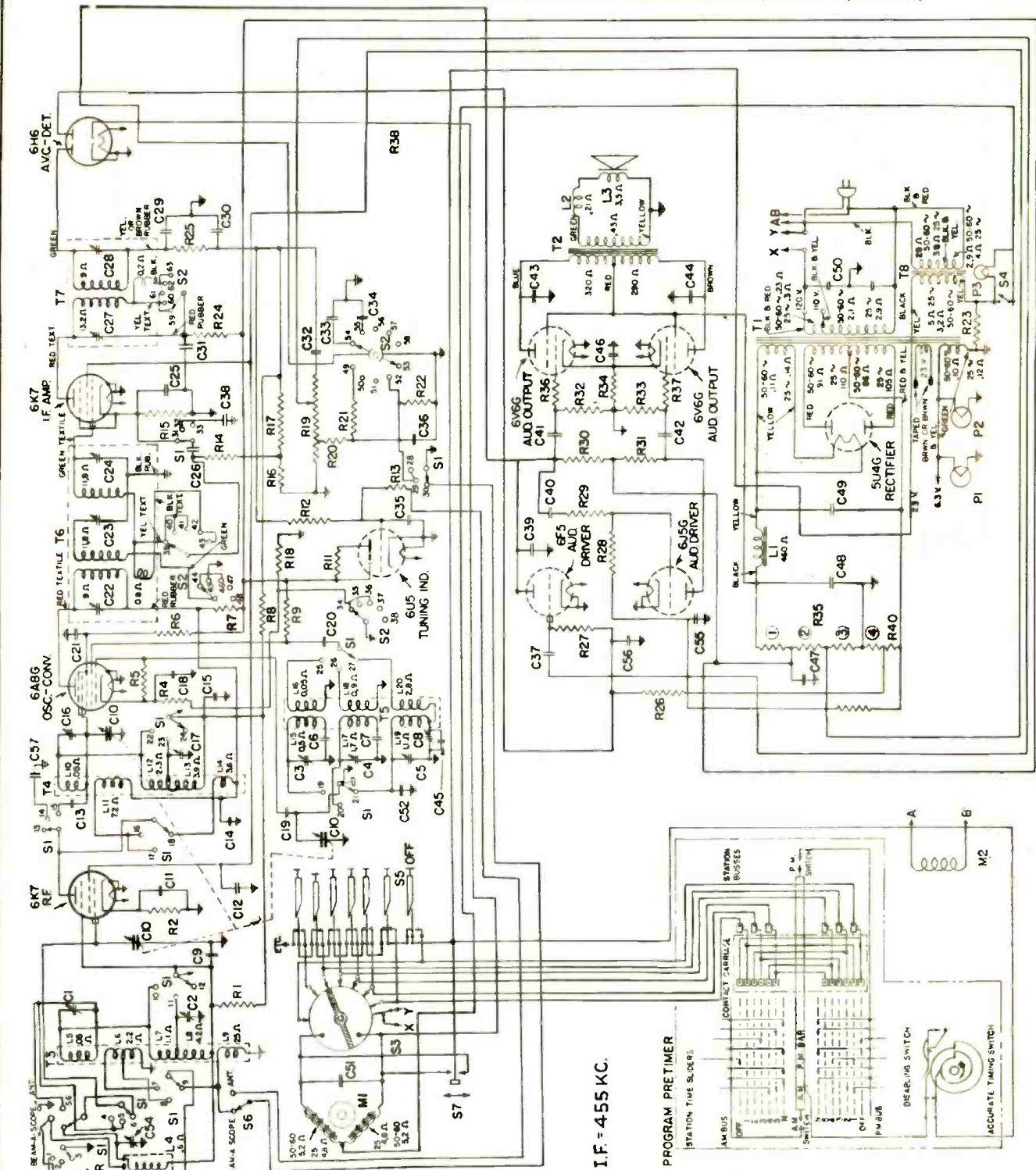

I.F. = 455 KC.

- | | |
|--|---|
| <p>RESISTORS</p> <ul style="list-style-type: none"> R1—0.22-meg. R2—330 ohms R3—330 ohms R4—330 ohms R5—47,000 ohms R6—39,000 ohms R7—1,000 ohms R8—1.8 megs. R9—22,000 ohms R11—1 meg. R12—2.2 megs. R13—2.7 megs. R14—2.2 megs. R15—330 ohms R16—56,000 ohms R17—0.22-meg. R18—330 ohms R19—2 megs. R20—68,000 ohms R21—68,000 ohms R22—1.2 megs. R23—1,000 ohms R24—1,000 ohms R25—47,000 ohms R26—0.47 meg. R27—1.5 megs. R28—82,000 ohms R29—1.2 megs. R30—68,000 ohms R31—68,000 ohms R32—0.22 meg. R33—0.22 meg. R34—230 ohms R35—4 sections Voltage Divider R36—1,600 ohms R37—9,000 ohms R38—470,000 ohms R40—20 ohms <p>CONDENSERS</p> <ul style="list-style-type: none"> C1—5.40 mmf. C2—5.40 mmf. C3—2.20 mmf. C4—2.20 mmf. C5—7.23 mmf. C6—0.0032-mf. C7—0.0021-mf. C8—160-375 mmf. C9—05-mf. C10—10.450 mmf. C11—0.05-mf. C12—0.05-mf. C13—18 mmf. C14—0.1-mf. C15—0.05-mf. C16—2.20 mmf. C17—3.30 mmf. C18—0.05-mf. C19—50 mmf. C20—0.0047-mf. C21—0.05-mf. C22—100-230 mmf. C23—50-135 mmf. C24—50-135 mmf. C25—0.05-mf. C26—0.05-mf. C27—50-135 mmf. 2d C28—100-230 mmf. 2d C29—150 mmf. C30—150 mmf. C31—0.05-mf. C32—0.02-mf. C33—0.0055-mf. C34—0.002-mf. C35—0.05-mf. C36—0.0055-mf. C37—0.02-mf. C38—0.01-mf. C39—270 mmf. C40—0.02-mf. C41—0.05-mf. C42—0.05-mf. C43—0.003-mf. C44—0.003-mf. C45—175 mmf. C46—25 mf. 25 V. C47—10 mf. 400 V. C48—30 mf. 450 V. C49—30 mf. 450 V. C50—01-.01-mf. 250 V. A.C. | <p>MISCELLANEOUS</p> <ul style="list-style-type: none"> Field Coil 460 ohms cold Voice Coil 3.5 ohms Pilot Lamps 6.3 V.—0.25-amp. Tuning Lamp 25 V.—0.2-amp. |
|--|---|

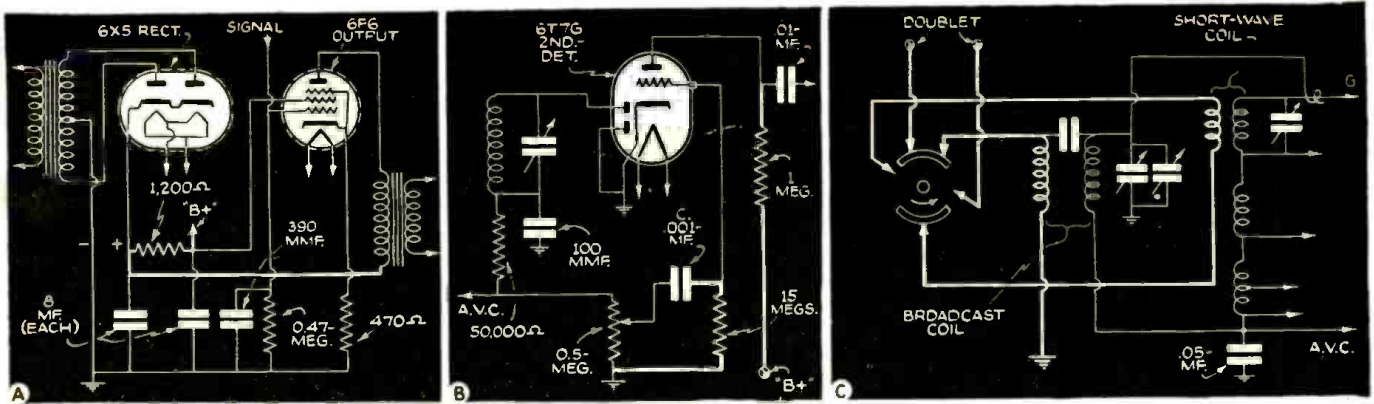

Fig. 1. New circuit details of (A) RCA, (B) Silvertone and (C) Zenith Sets. The heavy lines accentuate the features.

NEW CIRCUITS IN MODERN RADIO RECEIVERS

The details of the modern radio receiver circuits that make them "different" from previous designs are illustrated and described each month by a well-known technician.

F. L. SPRAYBERRY

NUMBER 15

(1) IMPROVED LOW-FREQUENCY RESPONSE

RCA Model 9M2. In this receiver the low-frequency response is improved through the segregation of the output plate and screen-grid supplies at the filter.

The main series filter section consists of a 1,200-ohm resistor as shown in Fig. 1A. All voltages to the plates and screens of the receiver are supplied through it, except the plate of the 6F6 output tube.

Now when the signal output is large or when it consists of low frequencies, or both, the power supply is called upon to furnish large amounts of current instantaneously. Even down to 100 cycles, large instantaneous currents may be drawn directly from the rectifier without materially affecting the filter output voltage. Therefore, at large signal outputs, especially at low frequencies, the screen-grid voltage of the output tube remains more stable.

When the screen-grid and plate of the output tube are supplied from the same source, having the necessarily bad regulation characteristic of the high-vacuum rectifier, the filter output is exhausted of supply quickly, causing the speaker to "whisper" at low frequencies. De-

pending on only the rectifier and not the filter lag the operation is improved.

(2) UNUSUAL DETECTOR CONSTANTS

Silvertone (Sears, Roebuck & Co.) Model 101.528. A detector circuit using a 15-megohm control-grid resistance and a 0.001-mf. audio coupling condenser is described.

The plate load resistor for this detector is 1 megohm—this is unusually high, as rarely do we find as high as 0.25-meg. resistors in the plate circuits of detectors. This means that the actual plate voltage is extremely low, between 30 and 40 volts. It can be measured only by a sensitive vacuum-tube voltmeter. The 6T7G tube used which would ordinarily have a -3 volt bias, in this case, has no bias applied and depends for its bias on electron evaporation from the cathode. The latter may amount to as high as ½-volt and the peak grid signal is rarely greater than this, at the grid.

By using a 15-meg. grid resistor (see Fig. 1B), a 0.001-mf. coupling condenser, C, may be used with a reactance of just a little more than 1.5 megs. at 100 cycles. This means that scarcely 10% of the signal will be lost across the coupling condenser at this low audio signal. This permits the economical use

of a mica condenser as a coupling unit, thus very much reducing leakage and losses.

(3) SELECTING ANTENNA WITH BAND

Zenith Models 7S204, 7S240, 7S242, 7S258, 7S260 and 7S261. Coupled with the band switch is an antenna selector switch which serves to make use of a single section of a doublet, with a pre-selector filter for the broadcast band; and a doublet without the preselector for short-wave bands.

The circuit is given in Fig. 1C. In the position of the band switch shown, one of the doublet conductors is free, while the other feeds into an antenna coil as a part of the preselector circuit. Such a preselector is needed for adequate tuning in the broadcast band while, due to the high frequencies, such a system is not desirable for high-frequency bands. However, the doublet or tuned antenna is much preferred for high frequencies, and is therefore, switched into use with the changing of a band from the broadcast band to the higher-frequency bands.

(4) AUTOMATIC STATION PRE-TIMER

General Electric Model G-106. Circuits are arranged so that any one of 6 local (Continued on page 382)

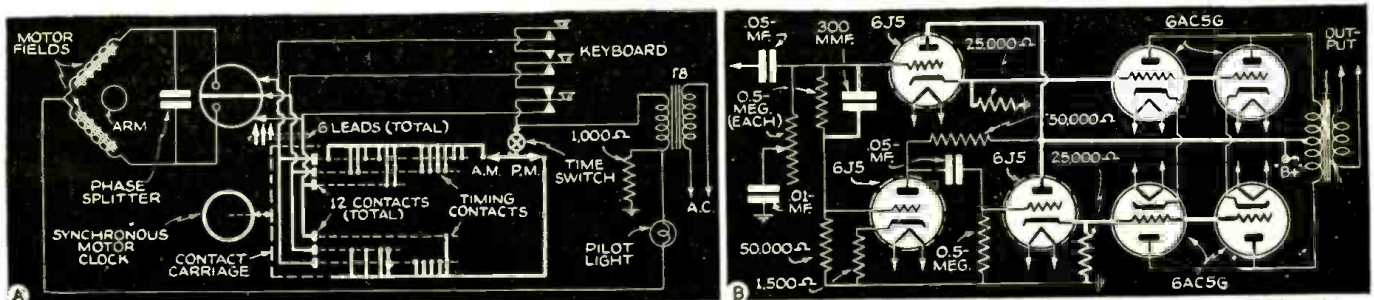

Fig. 2. New circuit features of (A) General Electric and (B) Emerson receivers. The heavy lines accentuate the features.



C-D

**CONSISTENTLY DEPENDABLE
CAPACITORS FOR  25 YEARS
FOR RADIO SERVICEMEN,
AMATEURS, AND EXPERIMENTERS.**

Write today for your copy of Cat. No. 161. Are you on our mailing list for the bi-monthly C-D house organ? If not write to

**CORNELL-DUBILIER ELECTRIC CORP.
1014 HAMILTON BLVD., SO. PLAINFIELD, N. J.**

DYKANOL ... PAPER ... MICA ... WET AND DRY ELECTROLYTIC CAPACITORS

ALL EYES ARE ON....



THE WESTON VACUUM TUBE VOLTMETER

\$50⁶³
NET

TO SERVICEMEN IN U. S. A.
(carrying case extra)

**The most versatile
... most profitable
low-priced instru-
ment for dynamic
or channel testing!**

Here's what you can do with the
WESTON Vacuum Tube Voltmeter:

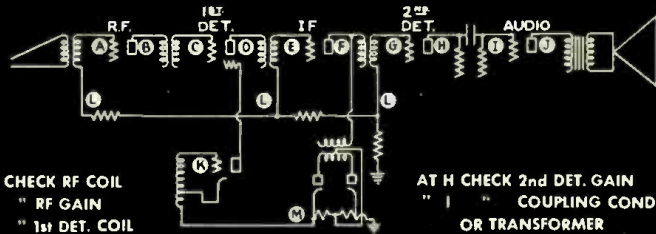

- AT A CHECK RF COIL
- " B " RF GAIN
- " C " 1st DET. COIL
- " D " 1st " GAIN
- " E " IF TRANSFORMER
- " F " IF GAIN
- " G " 2nd DET. COIL

- AT H CHECK 2nd DET. GAIN
- " I " COUPLING CONDENSER
OR TRANSFORMER
- " J CHECK AUDIO GAIN
- " K " OSCILLATOR VOLTAGE
- " L " AVC ACTION
- " M " AFC "

Before you buy... be sure to have complete information on this inexpensive fundamental servicing tool! Return the coupon today.

Weston Electrical Instrument Corporation
599 Frelinghuysen Ave., Newark, N. J.

Send data on the Vacuum Tube Voltmeter as well as Vol. 2 of the helpful WESTON Pointer.

Name _____

Address _____

City _____

State _____

All the worthwhile
Radio Trade News
of the past Month—
Digested for busy
radio men.

RADIO Trade Digest

A PLEDGE: — To
print the important
news of the radio
industry; to review
major news events;
to help point a path
to radio profits.

IMPORTANT HAPPENINGS OF THE MONTH IN THE RADIO INDUSTRY

No. 4

DECEMBER, 1938

No. 4

"FACSY" A FLOP? TRADE THINKS SO

*Big Percentage of Replies
Sees New Development
As Unimportant*

The tradition-toppling RTD questionnaire continues to pile up upsets, the latest being in the facsimile field. Until replies were tabulated, it had been the general belief that the trade was looking forward to facsy as a great business builder. But this, despite the interest shown by major broadcasting stations and set manufacturers, is apparently not the case. More than 3/4 of the replies indicated that their writers believe the new art will be of little if any importance to the industry, although the largest single tabulation voted facsy's importance great.

(Continued on page 370)

"Jobs For Men"

A package deal of radio, lamp, toaster & iron offered by 900 approved appliance dealers, under Consolidated Edison Co. plan, pulled 1/2-million initial orders for units with value of about \$3,500,000. According to mfrs., this order put 1500 more men to work at once; total added man-hours, 600,000.

TO HELP YOU SELL TUBES

YOU'RE RIGHT IN THE
"CHEERING SECTION"
WITH...

We Recommend

SYLVANIA
Set Tested RADIO TUBES

DUN & BRADSTREET SURVEY THE RADIO BIZ; FIND CAUSES FOR CHEERING AND WAILING

*Things Were Tough in First Half of Year, Survey Shows,
But Chances for 1939 Trade Boom Look Good
As Inquiries and Orders Begin Rise*

Radio opened its 1939 season with outlook brightest in many months. Rising consumer incomes, revival in home building, and improved prospects for automobile sales were counted upon to stimulate demand for all types of receivers. Extension of rural power programs promised broadening of potential market for electrically-operated sets. Reduced inventory holdings and more comprehensive price agreements testified to industry's progress in putting its own house in order.

Results for first 6 months of the year showed distributors' sales off as much as 60% against 1937 totals, with the average drop between 25 and 45%. Manufacturers' output reflected the severe curtailment. Narrowing of the gap from the previous year's level during the latter part of the period failed to raise the half-year total to within 70% of the 1937 comparative.

Production Schedules Advancing
For the industry as a whole, output averaged 30 to 40% below the same period of the previous year. Manufacturers in the low-priced field were able

(Continued on page 370)



"But I distinctly said I wanted a di-pole!"

6 Mo. Grace From FCC

Because frequency monitors meeting requirements "are not commercially available," the FCC has extended the working date of Rule 981 to March 15, 1939. This rule requires all relay, international, television, facsimile, hi frequency & experimental best stations to use a freq. monitor. The monitors used must have accuracy of at least 1/2 the tolerance allowed for the class of station with which used, but do not have to have FCC approval.

TO HELP YOU SELL TUBES

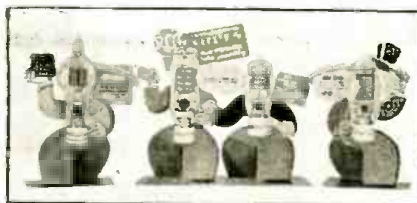

Left: Models Lucille Wilds and Harry Conover on colorful window display dramatize thrills of football brought into home by use of Sylvania tubes. Above: Brilliant cutouts for counter or window feature RCA xmtr tubes. Right: Nine sheets on the schedule pad of this Radiotron display help add to timeliness and local appeal; each shows 7 major games. (Cunningham display uses similar pad idea.)

TO HELP YOU SELL TUBES

YOU'RE RIGHT IN THE
"CHEERING SECTION"
WITH...

We Recommend

RCA RADIO TUBES

THE MOST SENSITIVE RADIO TUBE

RCA Radiotrons

LAW'S NEWEST WEAPONS

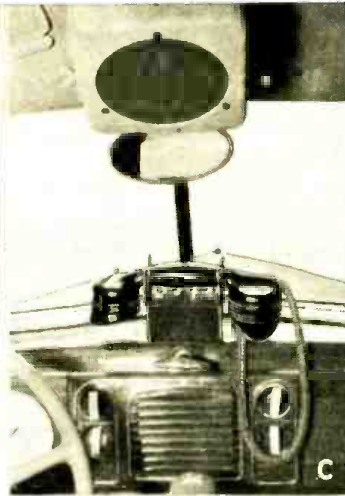
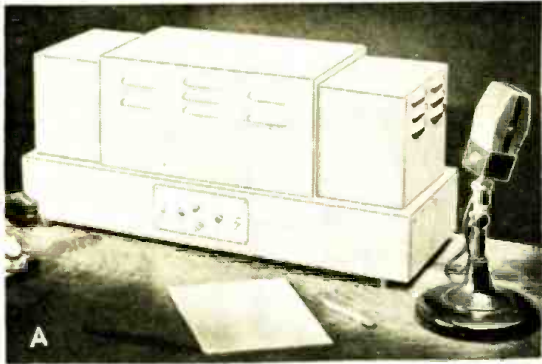

Upper-Left: New 25-watt police radio xmtr, as set up on a Despatcher's desk in headquarters. Lower Left: The 15-watt crystal-control UHF receiver & dynamotor, mounted in the rear trunk of a 1938 Ford. The receiver is in the foreground. Above: Control unit & handset mounted on dash of same car. All equip't in this layout is G-E except handset, which is by Automatic Electric Co.

Priess Plans Bests

Wm. H. Priess, Pres. of International Television Radio Corp., in an exclusive interview with an RTD reporter, disclosed plans for beginning broadcasts with his co's. non-electronic type of apparatus.

Priess' optical system is to radiate & receive 48 frames, of 200 lines each, per sec. This, he claims, is definition at least equal to cathode ray.

He plans to make xmtr equip't available to an upstate N. Y. station in early Spring & to put receivers in all local stores. Ordinary-size cabinet will house receiver; will pull out from wall on which it is to project picture 2 or 3 ft. wide. Outfit will be 9-tube job using Priess vibrator as scanner; will sell for about \$200.

Plans are to mfr. apparatus for stations in 1st 5 cities; after that, to license other mfrs. Program material will be the stations' worry.

Passed by the SEC, a 1,000,000 share stock sale is contemplated, Mr. P. says.

In case you don't know (or did you read "Mechanical vs. Cathode Television Systems," in the August 1936 issue of *Radio-Craft*?), Priess system uses a mirror that wobbles like mad in one plane, and lots faster in a second.

\$'s & No.'s

20c DIVIDEND payable on Oct. 25 to all stockholders of record on Sept. 23, by G-E, for the 3rd 1/4 of '38.

\$10,371,051 in new biz & renewals was booked by NBC on contracts beginning on & after Sept. 1. About 1/2 of this was cancellable.

MBS UP; CBS DOWN are what August figs. show, as compared with '37. The up was 70.4%; the down, 27.2%.

1939 BRIGHT, according to the Dun & Bradstreet report on radio, just released. A digest of the report appears (Continued on page 372)

BOOSTS COLLEGE SPIRIT



New Stewart-Warners are enameled in college colors, marked with college letters, sold to college lads & grads. Charley Rohn, college All-American player, must have caught sight of the press agent, from his expression.

SCANNING THE TELLY FIELD; ACTIVITY HI, PROGRESS LO

NBC's Telly Tours — Garod's Kit — FCC's Committee — Foreign Notes — Britain's Headache

NBC inaugurated television tours, to show public what telly was & will be. With little advance ballyhoove, the 1st 10 days of telly tours drew about 3/4 as many tourists as did equal period of radio tours when started in '33; the figs., telly 4,500, radio 5,951. However, telly tourist figs. were helped by Labor Day, which drew more than 1/2 of the 4,500.

Most newspaper men seemed to think 30-minute telly tour inadequate for price charged, but public appeared satisfied. According to pages, question most asked is not "How much will sets cost?" or "When will sets be available?" but "When will full color telly be ready?" Page also states 50% of the announcers will be femmes when bests begin in earnest.

GAROD'S KIT AT WHOLESALE

Garod (remember?) demonstrated a television kit to retail at \$99.90 with tubes or \$49.95 without. Set is a 16-tube job, producing a picture of about 3 x 4 in. with adequate brilliance and definition. Among the 1st cos. to advertise the outfit is Wholesale Radio Service Co., in its latest catalog. Garod claims

(Continued on page 370)

STOP IN, TELLY TOUR

NBC TELEVISION TOUR

provides new thrills for Radio City visitors

Regular tours not offer opportunity to see Television

Ad, above, pulls public in for 30-min., 55-cent tour showing complete story of television. Inset, Robt. Morris & Betty Goodwin, of NBC staff, look at the wide open teleceiver, which is one of the high spots of the tour.

AN EDITORIAL

By Artie Dee

"Radio in every room" has long been the dream of every manufacturer, jobber and dealer who has an eye for profits. It has also been the dream of every man, woman and child who listens to radio broadcasts. But it has been economically impossible, save for the very rich.

Now *Radio-Craft* has taken the lead. It has made plans for opening a brand new market—a market which gives the consumer a radio in every room (yes, even there, too, doggone it) —and which gives dealers, **Time & Money** jobbers and manufacturers an undreamed-of outlet. The payments which the consumer makes will be strung out over a longer period of time than even the most liberal of installment houses would allow—yet the dealers or jobbers selling the apparatus can get their money out of it immediately!

Does this sound too good to be true? Well, it isn't. N. H. Lessem, Associate Editor of *Radio-Craft*, worked it out. He took the idea to R. D. Washburne, Managing Editor, and Hugo Gernsback, Editor-in-Chief. They immediately saw its tremendous possibilities, and plans were made for an \$8,000.00 investment, to give this plan a real field test. Remember that magazines don't spend even 8,000 cents on an idea unless they're positive it's mighty good!

If you're on your toes, you have begun to wonder what this new merchandising plan is. You're going to be told. And it will knock you for a loop. You will walk around kicking yourself because you have been letting these extra profits pass you by for so many years. For, like all good ideas, this *Radio-Craft* sales plan is simple—almost obvious.

It's on the fire! It's in the works! No detail has been overlooked. The staff of

EXECS IN THE YARD



John W. Million, Jr., Pres. of Million Radio & Television Labs., Chi., takes time out for a smoke with H. D. Von Jeneff, the co's. new chief engineer. H. D. V. J. was previously with Wells-Gardner, Continental, Littlefuse, etc.

BIZ OPPS

A West Coast reader writes:—"I am desirous of procuring printed matter & prices from a number of mfrs. of lead or feed screw devices which are sold separately for several machines, & these features are desired:—500-ohm head; about 100-108 lines per in.; center drive from shaft of turntable; head damped for acetate." To contact, address Box AA7, c/o *Radio-Craft*.

BALSA BACK

Remember balsa wood, the stuff they used to use for large-diaphragm speakers? The International Balsa Co., 100 Boyd Ave., Jersey City, N. J., is booming it again as a multi-purpose material. Among the uses they suggest are, for soundproofing bestg & recording studios for baffles, packing, etc.



Amer. Telly Corp. shut down all production. This has been diversely attributed to (1) temporary discontinuance of transmissions by RCA; (2) clamp down on patent sitcheeyation, with RCA demanding \$40 royalty per set; (3) adverse publicity on stock sales; (4) lack of consumer & dealer interest in the ATC product. You can take your choice—or think of another reason. Or wait & see when (& if) ATC resumes. They were claiming production schedule of 100 sets. . . .

Radio-Craft is preparing it for publication, and in a future issue, all will be disclosed. You will be told how you can profit from the greatest merchandising plan the radio industry has discovered since the advent of broadcasting.

Sounds good? It is good!

When this hits the stands, *Kadette* should be out with a wireless remote control applicable to existing sets *World Transcription System* (WBS subsidiary) plans to have 75 outlets on its platter net Similar to wireless remotes is *Home Talkie Sound Labs'* home movie sound adapter; it couples to standard set via R.F. oscillator; adapts silent projector to talkie films. . . .

The filament wires in the new 1.4-V. low-current tubes are .0008 in diameter; X-section is 1/15 area of human hair, & it takes 104 miles of them to weigh a pound *Sprague's* DR paper condensers are sealed in aluminum cans & mount like electrolytics *Finch Labs.*

(Continued on page 373)

TIMESAVER = MONEYMAKER



When business booms, wasted time means lost sales. Universal Stamping & Mfg. Co., Chi., announces new Coinometer in 4 models, with 10-yr. guarantee.

MUFFLES SOUP SERENADE



Lunchroom of RCA-Victor plant at Camden has 5 hi-fi speakers (2 shown in pix) so eating employees may hear co's. newest records; also speeches & announcements from bosses. Time was when a man could call his lunch hour his own, but these diners seem not to mind.

FCC OKAYS EQUIP'T FOR BCST STATIONS

9-Page List Tells What Items Have Won Engineers' Approval

The latest release by the FCC, too long for reproduction, cites individual items which have won a Commission okay for use by broadcasting stations.

As an aid to station engineers, RTD lists the cos. whose products are on the approved list. The figs. in parentheses indicate the number of items thus okayed. Abbreviations following parentheses indicate type of equip't.

American Piezo Supply Co., 40th & Woodland Ave., Kansas City, Mo., (3) AFC; American Sales Co., 44 W. 18th St., N. Y. C., (1) xmtr; Bliley Electric Co., 203 Union Station Bldg., Erie, Pa., (1) ATC; Collins Radio Co., Cedar Rapids, Ia., (26) AFC, xmtr; Commercial Radio Equip't Co., 7205 Baltimore St., Kansas City, Mo., (1) AFC; De-Forest Radio Co., see RCA, (7) AFC, (Continued on page 371)

CHANGES IN ADDRESSES

New companies are being formed, new representatives appointed. Here are the latest data for your files.

STATION WEVD moved to own bldg., occupying 4th, 5th, 6th floors & penthouse at 117-119 West 46th St., N.Y.C.

RADIO PROGRAM EDITORS, new biz at 25 West 51st St., N.Y.C., to "discover & develop new radio writers"; run by Ted Byron & R. B. Seymour.

BOSSSES BOSTON BRANCH



Meet C. M. Wilson, mgr. of the new G-E branch at 700 Commonwealth Ave., Boston, Mass., which now wholesales major lines in area formerly served by W. L. Thompson, Inc. Thompson retains only watercooler sale-&rental biz. Operating Mgr. of new branch is V. W. Brown. Also there, handling biz formerly centering in Buffalo, N. Y., is J. A. Ramsey.

PORTABLE P.A. SYSTEM

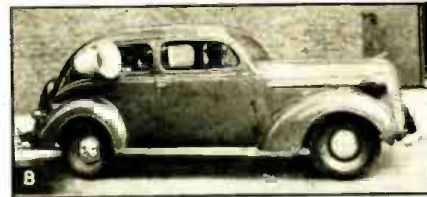

Microphone or phonograph can be used with this Wholesale Radio Service Co. (N. Y. C.) outfit. Case shown at top houses 9-tube amplifier, generator & all controls. Tubes reached by removing turntable. Speakers in lower shot are 12-in. P.M. Normal output of job is 30 watts; response flat within 2 db., 50 to 10,000 cycles.

Sales Helps & Deals

RCA-Victor dealers are being offered a series of 13 talkies to promote the 1939 line locally. Each film is in drama form & runs 1 minute; the film plugging the 97KG console grand is in full color. Theaters will run the pix once per show & be paid according to size of audience. RCA computes cost to dealer will be between \$8 & \$9 per wk.

Philco is pushing its farm radios with a 15-minute talking slide film (whatever that is) called "Let's Have Some Music," released to distribs. It's for dealers—not the public—and shows inventions, developments, sets, & sales methods, including the farm paper adv. campaign & the 4-page tabloid paper being mailed to 11 million rural homes.

Ken-Rad has a series of 4 window cards, & a window trim set consisting of 3 streamers & 4 other small pieces lithoed in color, for jobbers & dealers. They report demand good.

National Union Radio Corp. is giving distributors & their salesmen a new 102 page sales manual, containing illustrations & descriptions of standard make instruments with data on how obtained free on deals. Book also contains dope on N-U sales execs., products, sales helps, business forms, deals, & the sales story.

TIPS ON EXPORT

Tariff on dry batteries shipped to Ecuador has dropped 30%; storage batteries unchanged at 25%, a.v. Get a copy of *Electrical & Radio World Trade News* from U. S. Bureau of Foreign & Domestic Commerce, Washington, for dope on the Argentine agreement, too long to run here.

PERSONALS

GEORGE S. JAMESON, for 50 years an employee of G-E, was honored on the anniversary of his employment. Over 400 fellow employees attended a banquet in his honor at Swampscott, Mass.

RUTH CHASE, sec'y to E. L. Gove, tech. adviser of WHK-WCLE, was married to JAMES BENNETT by the REV. DAVID E. LAMB.

HAROLD W. HARWELL has resigned as V-P & Gen. Mgr. of Cinaudagraph Corp., Stamford, Conn. SHERMAN REESE HOYT, V-P, has become Gen. Mgr. JOHN SHERMAN HOYT remains Pres.; HOWARD C. SEAMAN, Secy. & Treas.

EUGENE T. TURNEY, JR., W2APT, has joined the staff of H. A. Marsh Adv. Agy, N. Y. C., as technical copy-writer.

WALTHER BROS., Montgomery, Ala. (Memphis Div.), leads the country in Philco sales. Leaders in other divisions are Empire State Distribs., Albany, N. Y. (Eastern); United Tire Stores, Trenton, N. J. (Atlantic); Philco Distribs., Providence, R. I. (Yankee); (Continued on page 373)

LAUGH OF THE MONTH

We never thought the English a very pushing people, but under the press of business, almost anything is likely to happen, as this press clipping from Wireless Retailer & Broadcaster.

Push-button is being strongly pushed by R.M.A. press publicity. This is positive selling and its value cannot be over-estimated.

NEW PUBLICATIONS

CLARION CAT., FALL 1939. Transformer Corp. of Amer., 69 Wooster St., N. Y. C. Clarion sound systems & accessories, including amplifiers, baffles, mikes, speakers, etc., at new low lists. Free to all applying for membership in "Clarion Inst. of Sound Engineers."

AUDAK CAT. SHEET. Audak Co. Inc., 500 5th Ave., N. Y. C. Prices on new compensated and "relayed-frequency" microdyne pickups and others. Also recording heads.

REPLACEMENT PARTS BOOK. 28 pp. Philco Radio & Television Corp., 3701 N. Broad St., Phila., Penna. Covers all of mfr's. home & auto sets (over 300 models); lists over 5000 of mfr's. parts, with cross-index. Mfr. has also published folder on test instruments, test bench & portable amplifier. Second folder, too, showing features of mfr's. 1939 sets (11 pictured & described), safety aerial, etc. Third describes Mystery Control.

VIPOWER. 4 pp. Radiart Corp., (Continued on page 375)

The address of any mentioned manufacturer will be sent on receipt of a self-addressed, stamped envelope. Mention of item number hastens reply.

THE LATEST RADIO EQUIPMENT

CENTRALIZED SOUND SYSTEM FOR SMALL SCHOOLS (1692)

(RCA Manufacturing Co., Inc.)

IN THE top, right illustration, a school principal makes an announcement to students in classrooms throughout his school, using the new low-cost RCA Victor "table model" sound-control cabinet designed for smaller educational institutions. At the touch of a finger the controls on either side of the radio dial send the message into any room or group of rooms he may select. The same switches are used to control the output of the high-fidelity radio set and the phonograph shown in the drawer. This centralized sound system permits 2-way communication between the principal's office and any classroom. The radio receiver covers the broadcast band as well as the 49, 31, 25 and 19 meter short-wave bands. Pushbutton tuning is provided for 8 stations. Manual tuning takes care of the others. The cabinet measures 42 ins. long, 18 $\frac{3}{4}$ ins. high and 13 $\frac{3}{4}$ ins. deep.

NEW WIRE-WOUND VITREOUS ENAMEL RESISTORS (1693)

(Aerovox Corp.)

KNOWN as the Pyrohm Jr. line, these resistors are made of special resistance wire having low temperature coefficient of resistivity, wound on refractory tubing. This assembly, including the terminal connections, is then coated with powdered glassy enamel and fired at red heat, resulting in a resistor covered with vitreous enamel tightly fused to the wire. Terminal connections and tubing. Proper annealing assures stable resistance. Terminal lugs and/or pigtail connections are provided. Units are available in the popular 10 and 20 W. sizes and in all values of resistance. The same refinements are reflected in the new Slideohm adjustable resistors (illustrated) available in 25, 50, 75, 100 and 200 W. ratings. One slider band is supplied with each unit, but additional bands may be added.

MEDIUM- AND HIGH-POWER VARIABLE TRANSMITTING CONDENSERS (1694)

(The Hammarlund Manufacturing Co., Inc.)

THERE are 29 different types in the new "TC" line of transmitting condensers, ranging in voltage from 2,000 to 7,500 and



Latest small size tube tester. (1697)

in capacity from 25 to 465 mmf. Twelve of these types are of the split stator variety. Designed for amateur, experimental, and laboratory use, these condensers have many new features. Some of them are: non-magnetic rotor assembly, polished round edged plates, silver plated Beryllium contacts and isolantite insulation. The rotor is fully floating, eliminating shaft binding and twisting. The units are available with 6 different plate spacings, ranging from 0.030-in. air gap to 0.230-in. air gap. The condensers are designed for medium- and high-power operation and are especially desirable in high-efficiency circuits.

FLEXIBLE SCHOOL SOUND SYSTEM (1695)

(Bell Sound Systems, Inc.)

ILLUSTRATED is a panel-type desk model sound system for use in schools having 30 rooms or less. Some of the features are: high-quality radio, talk-back for inter-communication, 24-W. amplifier with bass and treble compensation, heavy-gauge steel construction cabinet, provisions for phonograph attachment, audible monitor, and master switch for each panel of 10 switches.

The system is flexible in that additional 10-switch panels may be added at will to afford additional installations.

NEW PHONO-RADIO COMBINATION (1696)

(Stewart-Warner Corp.)

INCLUDED in Stewart-Warner's new 1939 line of radio sets is a handsome table model phono-radio (illustrated). It has a 6-tube chassis, magic keyboard, automatic tuning, receives standard broadcast and one police band and has a self-contained phonograph unit (exposed by raising the cover of the instrument) that will accommodate 10- and 12-in. records; it is powered by a self-starting motor. Frequency range is 540 to 1,720 kc. Other features include illuminated edge lighted dial, automatic volume control, resistance coupled pentode audio system, 2-position tone control, built-in code rejection filter, and 6-in. dynamic speaker. The phono pickup is of the high-fidelity crystal type. The cabinet is of American walnut in vertical and horizontal stripes with hollywood inlays.

(Continued on following page)



New phono-radio combination. (1696)



Centralized sound school system. (1692)

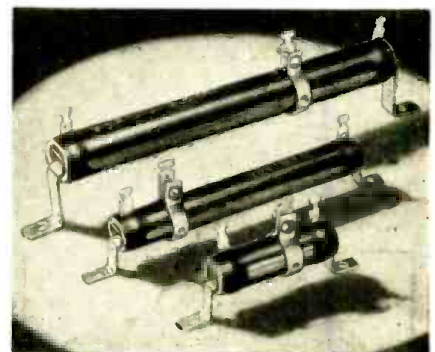

Wire-wound vitreous enamel resistors. (1693)

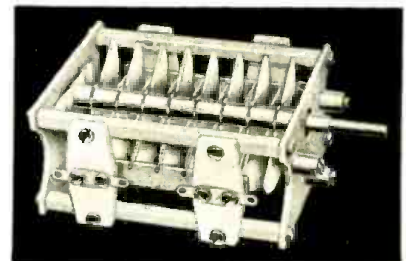

New variable transmitting condensers. (1694)

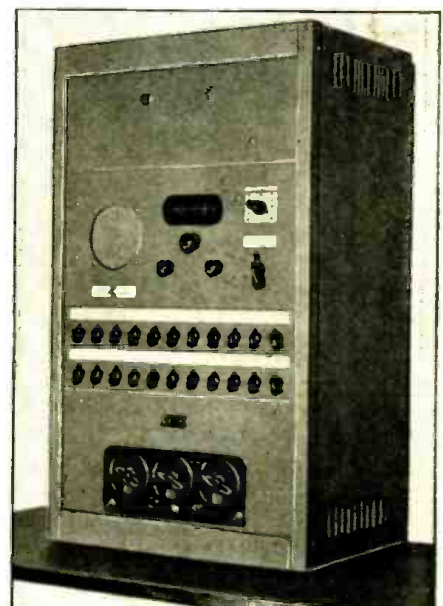

Flexible sound system for schools. (1695)

THE LATEST RADIO EQUIPMENT

(Department continued from preceding page)

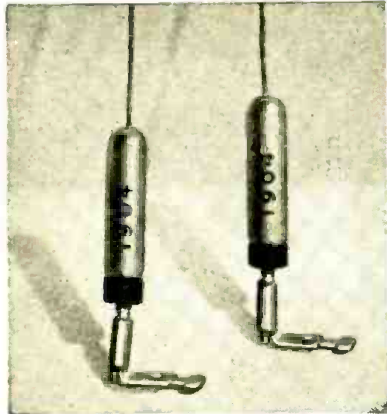

Liquid-heat compensated condensers. (1698)

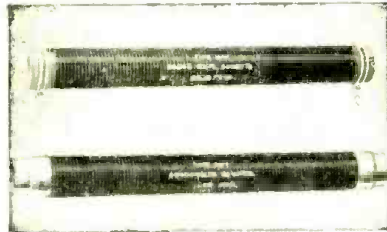

New "spiral" high-voltage resistors. (1699)



Photoelectric light meter. (1700)

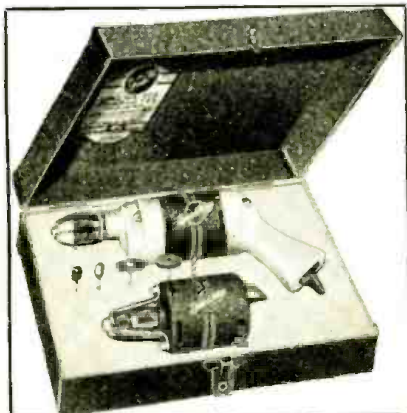

Matched set of portable electric drill and hand grinder in steel case. (1701)

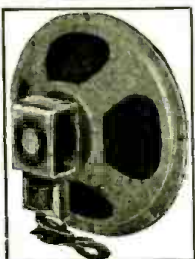

New line of replacement speakers having universal fields and universal output transformers; power handling capacity, 2 1/2 W. Ideal for Servicemen who do not wish to carry large stock. (1704)

NEW SMALL-SIZE TUBE TESTER (1697)

(Simpson Electric Co.)

WEIGHING but 7 lbs. and known as the model 333, this instrument incorporates all the usual tube-testing features as well as a number of entirely new ones. Provisions have been made for testing pilot lamps of various filament voltages as well as Christmas tree bulbs. It will test ballast tubes direct in socket for burn-outs and opens; also tests gaseous rectifiers of the 0Z4 type.

Double filament switching is provided for testing special tubes, such as 5X4G, 5Y4G, 6A5G, 6P7, etc., without the use of adapters or special sockets. There is also a jack for "noise test" as well as a neon bulb for checking shorts. The tester has a large 5-in. modern-shaped meter with an exceptionally long scale marked "Good" and "Bad." Tube charts are provided in looseleaf form. A standard R.M.A. circuit is used.

LIQUID HEAT-COMPENSATED CONDENSERS (1698)

(Sprague Specialties Co.)

DUE TO the action of the liquid dielectric, the condensers in this new line decrease their capacity with an increase in temperature. These condensers are made in 2 types ranging in capacity from 5 to 9.5 mf. For a 30 degrees (Centigrade) rise of temperature there is a negative drift of from 0.1 to 1.6 mf. They are intended primarily for use in the broadcast band. From 0.5 to 2 megacycles the ratio of capacity to Q is about 0.04 for condenser type No. 1 and about 0.05 for type No. 3. This ratio (C/Q) is a measure of the loss added to a tuned circuit. The metal containers are 1/4-in. in diameter by 1 1/8 ins. high.

NEW HIGH-VOLTAGE RESISTORS (1699)

(International Resistance Co.)

VOLTAGES up to 100,000 at 150 W. become entirely practical with these new high-voltage resistors when constructed as a spiral formation of the "metallized" resistance element on the ceramic base—a tube 18 1/2 ins. long by 2 ins. in diameter. The excellent characteristics of these new units opens a vast new range of possibilities for the design of high-voltage equipment.

Five standard units rated at 5,000, 10,000, 25,000, 50,000 and 100,000 V. are available, with a wide variety of special resistors being supplied for both experimental and production use.

NEW PHOTOELECTRIC LIGHT METER (PHOTOMETER) (1700)

(Dr. F. Loewenberg)

THIS universal photometer is a sensitive, portable, light-measuring instrument. For general purposes it is equipped with a single photocell which permits distinguishing light values down to 1/100 foot-candle. Some of its uses are measuring illumination, brightness, density, light transmission and absorption and reflection. It can further be used for testing automobile headlights, motion picture screens, determining exposure in photography at low light levels, color-photography, micro-photography, photo-enlarging and contact printing and photo-engraving.

The photometer consists of a wooden case containing a galvanometer and a photoelectric element. The galvanometer registers the current generated by the photocell. The color sensitivity of the photo-element exceeds that of the human eye in the blue as well as in the red. By means of a special green filter, this excess sensitivity can be eliminated so that the element reacts to colors just as the eye.

MATCHED DRILL AND GRINDER SET (1701)

(Speedway Manufacturing Co.)

SERVICEMEN, set builders and experimenters will welcome this new tool kit, consisting of a tiny 1/4-in. portable drill and hand grinder, supported by a complete line of accessories sold individually or in a complete set. The electric drill and hand grinder are available in a steel case as illustrated. The drill is about the size and weight of a small pocket revolver and handles with much the same ease and accuracy. The grinder which has been foreshortened to the proportions of a small apple, fits comfortably into the hand. Though exceedingly small it is claimed that these new tools pack a good wallop. The drill operates at 100 r.p.m. and has a chuck for a 1/4-in. drill. The grinder operates at 20,000 r.p.m.

"TATTLEITE" (1702)

(Littelfuse Laboratories, Inc.)

THESE pocket-size testers "tell-the-tale" to electricians, line men, radio and refrigeration Servicemen and electrical maintenance workers. They test for live or open circuits, blown fuses, defective condensers and resistors and tell whether current is alternating or direct. They further indicate

(Continued on page 359)

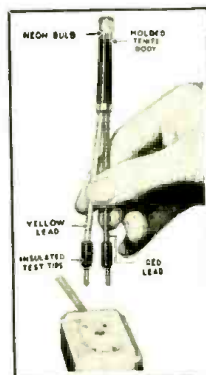

Handy pocket tester. (1702)



A.C. electrolytics for motor starting. (1703)

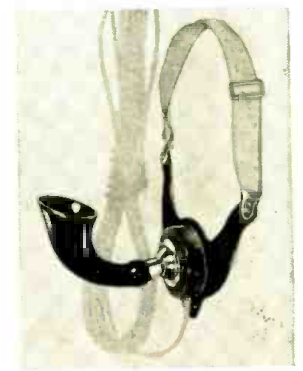

New breast-type microphone. (1705)

THE LATEST RADIO EQUIPMENT

(Continued from page 358)

grounded lines and approximate voltage. The instrument utilizes a tiny neon bulb which glows on only 1/10,000 of an ampere. It is housed in a molded case together with its series limiting resistor.

ELECTROLYTICS FOR A.C. (1703) (Cornell-Dubilier Electric Corp.)

THESE high-capacity dry electrolytic A.C. condensers are designed for many A.C. applications, such as motor starting during the starting cycle of the motor, where high capacity is necessary for intermittent use, and for operation involving a maximum of 20 starts per hour, each start of 3 seconds duration. These electrolytics (type JDF) are recommended for use with fractional horsepower motors of the type used in refrigerators, oil-burners and similar appliances.

The condensers are hermetically sealed in lock-seamed aluminum containers and are equipped with a special bakelite terminal block having 2 dummy screw terminals. Terminals are arranged for convenient wiring to motor, line and thermostat, in refrigerator applications.

RADIO SERVICE SPEAKERS (1704) (Wright-DeCoster, Inc.)

MANUFACTURED especially for radio Servicemen wanting low-price speakers which will give good reproduction. They are so designed as to replace a good variety of speakers and are therefore ideal for the Serviceman to stock. The specifications are as follows: power handling capacity, 2½ W.; voice coil diameter, ¾ in.; voice coil impedance, 5.3 ohms at 400 cycles; universal field coil, 2,500, 2,200 and 1,500 ohms, 1,800 and 1,800 tapped at 300 ohms. The speakers are supplied with universal output transformers having primary resistance of 1,250 to 11,500 ohms for single tube output and 3,750 to 11,500 ohms for push-pull output.

"ROUND-THE-NECK" MICROPHONE (1705)

(Sundt Engineering Company)

A BREAST-TYPE microphone which is claimed to be more convenient to use than either the lapel or hand-type microphone! As shown in the illustration, a microphone crystal is housed directly beneath a speaking horn similar to that used in telephone work. A breast plate and neck band hold the horn within a few inches of the speaker's mouth. The result is a microphone always in the optimum position, with the sound concentrated on the active part of the crystal. It is claimed that the output is 5 to 6 times that obtained from a lapel microphone and 2 to 3 times that of a hand microphone. Feedback is practically eliminated because of the directiveness of the horn.

MANHOLE LOUDSPEAKERS

(Continued from page 340)

price; an installation at the new Breslau Stadium has shown that this type of loud-speaker arrangement is less costly than most other types. Arrows, in drawing B, indicate 2 additional "manhole" loud-speakers.

The photo at C shows how the new underground speakers are installed into the pit. The system is installed into a water and dustproof chassis, and is suspended from the heavy cast iron coverplate. Servicing such a system is very simple, because every part of the speaker is easily accessible.

LET THE POSTMAN BRING YOU THIS FREE CATALOG



AMERICA'S GREAT BUYING GUIDE

FREE

LAFAYETTE Model B-49
SUPER B-49 \$8.95
5 TUBE AC-DC WALNUT ONLY



ZEPHYR F.3.5 LENS
CANDID CAMERA \$22.50

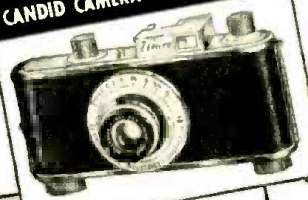



188 PAGES OF GREAT VALUE

Your buying guide, and a saving guide, too. That's the story behind this new **FREE** catalog. To bring you the latest, the best in 1939 Lafayette radios, parts, tubes, Public Address equipment, and amateur apparatus—all at thrifty prices. There are over 50,000 items in this great book, and every

single one a standout buy! Mail coupon today for your **FREE** copy. Wake up to sensational values!



1939 LAFAYETTE RADIOS
PUBLIC ADDRESS SYSTEMS
50,000 PARTS & TUBES
ELECTRICAL APPLIANCES
AMATEUR APPARATUS
TELEVISION KITS
CAMERAS

TAKE THE GUESSWORK OUT OF YOUR CHRISTMAS SHOPPING WITH THIS NEW

FREE Gift CATALOG

To make your Christmas shopping easier, to enable you this year to give beautiful, worthwhile gifts at money saving prices, we offer a special **FREE** Christmas-shopping catalog. Send for a copy today. It's crammed full of electric trains, cameras, modern appliances, electric shavers, radios—gifts for Mother, Dad, Junior, Sis, and the girl friend too. Mail the coupon today. It will pay you!



Valu-Bill says:
If you think I'm playing Santa Claus, get these **FREE** books and see for yourself!

7 branches to serve you

WHOLESALE RADIO SERVICE CO. INC.

NEW YORK, N.Y. • CHICAGO, ILL. • ATLANTA, GA.
100 SIXTH AVENUE • 901 W. JACKSON BLVD. • 245 PEACOCK STREET
BOSTON, MASS. • BRONX, N.Y. • NEWARK, N.J. • JAMAICA, L.I.

WHOLESALE RADIO SERVICE CO., INC.
100 SIXTH AVENUE NEW YORK, N. Y.

Rush **FREE** 1939 Radio Catalog No. 73-3M8

Rush **FREE** 1939 Gift Catalog No. 75-3M8

Name.....

Address.....

City..... State.....

PASTE COUPON ON PENNY POSTCARD



THE THEORY OF RADIO SERVICE WORK

Priceless Knowledge at your Command



Here's the BRAINS

ALL IN 1 BOOK
Everything you need to know about the theory of radio service work is explained to you in this big Ghirardi book. It teaches you exactly HOW to do every step of it—and WHY! Learn up-to-date factory servicing methods from the experience of leading service organizations—condensed and simplified for you in this convenient source-book.

BASIC FUNDAMENTALS
Here in compact form is your complete background on test instruments—how they work—how to use them; trouble-shooting; repair methods; and everything else essential for a thorough knowledge of modern radio servicing. Ghirardi makes it all wonderfully clear and easy to understand. With this solid foundation you will be prepared to tackle and solve the most difficult servicing problems you'll ever meet. Make yourself a better, more successful service man. Get your copy at once—with an absolute MONEY-BACK GUARANTEE. Mail coupon today!

- **Test Equipment**
42-page section, giving you the whole theory and construction of every type of test and servicing equipment: Diodes, construction sets, etc., etc.
- **Repairing**
184 pages of time-saving repair methods; superhet alignment; interference elimination; etc., etc.
- **Trouble-Shooting**
254 pages of latest shortcuts in tracking down all kinds of difficult receiver troubles.
- **Special Problems**
64 pages on Auto-Radio installation and servicing; All-Wave sets; High-Fidelity sets; AVC and QAV Circuits; Bellini and Advertising; etc., etc.

Ghirardi's MODERN RADIO SERVICING

1300 pp.
706 illus.

Radio & Technical Publ. Co.,
45 Astor Pl., New York, Dept. RC-128

Here is \$4 (\$4.50 foreign) for my copy of MODERN RADIO SERVICING.

Here is \$6.50 (\$7 foreign), the "Special Combination Price" for the above book together with Ghirardi's TROUBLE-SHOOTER'S HANDBOOK (see opposite ad).

MAIL NOW!

NAME.....
ADDRESS.....
CITY.....
STATE.....

Please send free literature describing detailed contents of MODERN RADIO SERVICING. \$4

Spot S-W PROGRAM TIME anywhere!

In a flash this new clever gadget shows you clearly the exact time anywhere in the world—translate Standard, Daylight and Greenwich Mean Time automatically. Amazingly simple, convenient, practical—never fusing and freezing. Just a turn of the dial and there's the time! Every Short-Wave fan and "ham" should have one.

Ghirardi's RADIO WORLD-TIME

Indicator GADGET

MAIL NOW!

Radio & Tech. Publ. Co.,
45 Astor Pl., New York,
Dept. RC-128

When and Where to Tune in any Station

RADIO COURSES

RADIO OPERATING—BROADCASTING
For Gov't License Preparation

- RADIO SERVICING — a practical course
 - RADIO AMATEUR CODE — TELEVISION
 - ELECTRONICS—1 yr. day course 2 yrs. eve.
- Day and Evening Classes. Booklet Upon Request.

New York Y.M.C.A. Schools
6 W. 64th Street New York City

THE RADIO MONTH IN REVIEW

(Continued from page 327)

(A successful battle was waged to keep the flood waters of the Connecticut River from the sub-basement of the Phelps Company's 9-story "Myrick Building," in which the power equipment for the entire block is located. This super-effort made it possible to produce the November issue of *Radio-Craft* with the least possible delay.) Hartford, Conn., from its Travelers Tower, highest point in the city, saw downtown streets flooded; a pick-up at Bellmore, L. I., site of WEAF's transmitter, described streets littered with debris, and how a \$48,000 yacht, which had been anchored 1/4-mile off-shore, had been tossed over the breakwater and deposited 25 ft. in on dry land; concluding the series of remote pick-ups was a contact with Washington, D. C., from which point Rear-Admiral E. R. Waesche, Commandant of the Coast Guard, reported on rescue work, and James Fieser, vice-Chairman of the American Red Cross, paid tribute to the work of the radio amateurs.

Special Features crews of WOR-Mutual, despite the weariness of following an all-night vigil on the vagaries of the European crisis, made remote pick-up at headquarters where Coast Guard operations along the ravaged Long Island coast were being directed. Throughout the day and until early the following morning homeward-bound New Yorkers were advised on delayed train schedules, rerouting of traffic and flooded highways which made it impossible in many cases to reach suburban communities.

In one instance, radio filled-in legs on an extensive communications circuit 60 times longer than usual. Montreal, Canada, reported that it could make contact with Halifax, 600 miles away, only by sending messages to Vancouver, British Columbia, on the West coast, thence by cable to Australia, and by various relays from there to Halifax, a round-trip distance of 30,000 miles!

TELEVISION

THE long-awaited R.M.A. Television Standards at last were submitted to the F.C.C. last month. Keep your fingers crossed!

Reynolds (London news agency) last month reported completion of arrangements for a "Television Dinner". Individual television receivers placed before groups of guests of the Royal Photographic Society in London were scheduled to show the ceremonies of a toast being given at Alexandra Palace to the Society and its honored guests, over whom the Duke of Kent was to preside.

In an effort to meet the growing cost of television, a stringent economy wave by the B.B.C. has resulted in turning a cold shoulder to anything that looks like expense. Morning programs will depend mainly upon the use of phono recordings, and provincial stations will be expected to supply a large part of each day's program material previously originated by the big National and Regional transmitters.

First "candid television" transmission in the U. S. was made last month of William O'Donnell, a bank-supplies salesman living in Manhattan, over RCA/N.B.C.'s station W2XBS. Pick-up was by means of the company's new mobile television station, which made possible sight-and-sound sidewalk "television interviews" of passersby in



THE PRACTICE OF RADIO SERVICE WORK

Brand NEW and it's a KNOCKOUT!



Here's the DATA

READY FOR ACTION

New as tomorrow's radio sets is this latest Ghirardi service-man's Handbook—a Handbook! Data?—say, it's packed jam full of just the kind of practical, time-saving servicing dope you really want in your shop—loads of indispensable, factory-checked servicing data boiled down to the real essentials—tabulated and organized for split-second reference. And right up to the minute—even for the 1938 model!

Get Aid for Set Troubles

Here, right at your finger tips are the answers to all the "tough ones." A matter of seconds to save hours of fiddling and fusing on hard service jobs. You've just got to see this new book! And you won't have to take a single chance because with our MONEY-BACK GUARANTEE you can return it within 10 days and get your money refunded. Don't fall behind. Don't let it slide. ORDER YOUR COPY TODAY!

- **Case Histories**
Trouble symptoms and remedies for over 2,000 sets, compiled from actual service records.
- **F. Peaks**
Over 12,000 listings for alignment of all superhets, old and new, including 1938 models and "orphans."
- **Auto-Radio**
Interference Elimination for over 80 car models; Installation and Cigarette System Data; Chart: Electrical Wiring Diagrams; Gear Ratios and Dial Directions of Tuning Controls.
- **Other Data**
Trouble-Shooting Charts; Servicing Recorders, Intercommunication Systems, P.A. Systems; Trade Directories; and over 30 other charts and tables on Tubes, Wire, Grid-Bias Resistors, RMA Color Codes, etc. Standard Manual Size (8 1/2 x 11).

IT'S NEW! RADIO Trouble-Shooter's HANDBOOK

OVER 500 pages

Radio & Technical Publ. Co.,
45 Astor Pl., New York, Dept. RC-128

Here is \$3 (\$3.50 foreign) for my copy of RADIO TROUBLE-SHOOTER'S HANDBOOK.

Here is \$5.50 (\$7 foreign), the "Special Combination Price" for the above book together with MODERN RADIO SERVICING (see opposite ad).

MAIL NOW!

NAME.....
ADDRESS.....
CITY.....
STATE.....

Please send free literature describing detailed contents of RADIO TROUBLE-SHOOTER'S HANDBOOK. \$3



JOIN AT THE HELM - in time of need

Rockefeller Plaza. The experimental transmissions hence used natural lighting, and were pronounced as satisfactory in every way.

Another step forward was taken, last month, when images were transmitted successfully from points on Long Island and in Westchester County by radio relay, operating on a 177-megacycle channel. This television relay employed the usual 441-line transmission, 30 complete images per second.

Inter-office television is here! At least, Uncle Sam last month granted a patent to Alexander McLean Nicolson of New York for a system purported to enable a person to be seen as well as heard, while conversing over an inter-office telephone. "Mr. Nicolson is not interested in any further publicity on his invention at this time," Radio-Craft was advised, when inquiries were made at headquarters in New York as to the method of operation employed. Meanwhile, Radio-Craft readers may wish to read up on the specifications contained in Nicolson patent No. 2,125,006.

Reasons why Englanders are hesitating about buying television receivers, are reasons which every American company contemplating the merchandising of television equipment should analyze. These reasons, as given by *Wireless Retailer & Broadcaster* (London), last month, are as follows:

- (1) People prefer to go out for entertainment;
- (2) programs are not good enough;
- (3) transmission times are too short;
- (4) people think sets would soon be obsolete;
- (5) they are afraid of costly replacements; and,
- (6) prices are too high.

Reported Reynolds (London news agency), last month:—the British Broadcasting Corp., forced to economize because of the enormous cost of television, wants to withdraw grants by which the Center Council for Broadcasting runs school broadcasts, and hand financial responsibility for their upkeep over to local education authorities. (Started by the B.B.C. as an experiment, radio school lessons have become a large and costly part of the broadcasting service. Last year, the number of schools using this program service upped nearly 40% over the preceding year.) Faced with empty coffers, B.B.C. says it has no alternative.

That's Government subsidy for you. Maybe the American system of broadcasting, in which Mr. John Q. Public pays the freight as usual, but via the advertisers instead of the government, would more readily adjust itself to such a condition. Anyway, it's handwriting on the wall; let's hope our suspenders aren't snipped.

Financial Reporter, the "security dealers' weekly" (to quote the masthead), last month carried on pg. 1 an article, entitled "Realization of the Television Dream Believed to Be But a Few Months Away", by William H. Priess, Int'l Telev. Radio Corp. proxy, which includes the following remark:

"The one lock still to be opened to release this tremendous, potentially stored up flood of business, is for some organization to break away from the cathode-ray principle and offer the public the sets it wants. . . ."

These sets, said Mr. Priess—an engineer whose inventiveness won recognition prior (Continued on following page)



WILLIAM SELLECK, Veteran Dispatcher

With **SUPREME** Instruments

Eight major airlines make 100 scheduled takeoffs and landings each day at the "Busiest Airport in the World." The Dispatcher in the Control Tower at the Chicago Municipal Airport must have constant communications on thirteen radio frequencies. All the equipment is the finest, so it is no wonder that years ago SUPREME instruments were selected for the difficult job of keeping those 13 receivers "perking" every hour of every day and night week after week, month after month! SUPREME was selected for the same reasons that more radios are tested each day with SUPREME instruments than with any other kind! It is the supreme tribute to Quality!

The instruments shown ready for instant use are the Model 582A Push-Button Signal Generator, the 546 Oscilloscope, and the lightning-fast 592 Push-Button Speed Set-Tester.

Your Parts Jobber sells SUPREME instruments on the lowest terms in radio history!

**MAIL
COUPON
TODAY**

SUPREME

SUPREME INSTRUMENTS CORP. GREENWOOD MISS., U.S.A.

EXPORT DEPT. ASSOCIATED EXPORTERS CO. 145 W. 45th STREET, NEW YORK, N. Y. CABLE ADDRESS: LOPPER, N. Y.

Supreme Instruments Corp.
Dept. RC-12, Greenwood, Mississippi
Please RUSH me information on:
Signal Generators
Oscilloscopes
SPEED Instruments

Name

Address

City State

GET A BEAUTIFUL DESK LAMP ABSOLUTELY FREE!

Complete details as to how it is possible to get a beautiful Desk Lamp FREE, appears on Page 374 of this issue. **TURN TO IT NOW!**

BRUSH HIGH LEVELER SERIES MICROPHONES

Range in price from \$22.50 to \$32.50. New Brush headphones.

Write for your Brush catalog today.

THE BRUSH DEVELOPMENT COMPANY
3312 PERKINS AVENUE CLEVELAND, OHIO

SOLAR MINICAP

Newest development
in Electrolytic Capacitors
Catalog upon request

SOLAR MFG. CORP. 599-601 Broadway, New York

THE RADIO MONTH IN REVIEW

(Continued from preceding page)

**HERE'S THE
'Inside Dope'**



Servicemen still prefer the wall type resistor element that hugs the inner circumference of the bakelite housing of the CENTRALAB

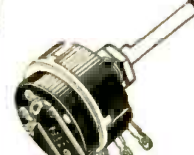

STANDARD REPLACEMENT UNIT.

- Maximum resistor length for case diameter.
- Close uniformity between resistors.
- Accurate tapers.
- Uniform current distribution.
- Lower specific resistance and attendant low noise level.
- Better power dissipation.
- Longer life.

The new 1938-39 Volume Control Guide (available at your jobber) now lists thousands of recommended replacements for all current and older receivers.

Centralab
MILWAUKEE WISCONSIN



"UNIFORM QUALITY"

FINE raw materials and precision manufacture both contribute to the uniform quality of Sylvania radio tubes. But even more important, we believe, is the fact that each Sylvania tube must pass scores of rigid tests before it is Okayed for Shipment.

Hygrade Sylvania Corp.,
Emporium, Pa.

SYLVANIA
Set-Tested Radio Tubes

to, and during, the World War—can be made now, and can be built to retail for about \$200, yet offer an image measuring 2 x 2 ft. A "small fry" company, he intimates, will be the one to point the way to an inexpensive, efficient television system more effective than any now provided-for by existing "standards" of television.

Since only 10% of present-day broadcasting station expense can be charged to equipment, an additional 10% expenditure would revamp these stations for television sight and sound, and at a net cost of only 2½¢ per person reached in covering 1/3 of the population of the U.S. Coaxial cable, he feels, is an untimely and unnecessary expense; duplicate reels of talkie film sent from a central agency would solve this problem and the other one of expensive talent for 1-time "stands", at least for a time. Admitting that there are limitations to television, he yet feels that it has possibilities not yet dreamed of, and concludes:

"Television is a power. An immeasurable power for human good. Can any possible force prevent it from bursting into a universal service? I think not, and I believe that its blossoming is a matter of but a few months. A mere few months between its promise and its realization."

MISCELLANEOUS

Possible monopolistic practices in chain and network broadcasting are now under investigation by the Federal Communications Commission, as item No. 12 on a schedule of 13 major points in a check-up started last month under "Order No. 37"! A "speak your piece" date of Oct. 24 was set for a general hearing of complaints.

On a guess, how many "regional" networks would you say have been licensed by the F.C.C.? Oh, yeah? well, see how far off you were—here's the list (exclusive of the "nationals", or N.B.C., C.B.S. and M.B.S.): Arrowhead, Duluth; Calif. Radio System, Sacramento; Colonial, Boston; Don Lee B.S., Los Angeles; Hearst Radio, Inc., N.Y.C.; Inter-City B.S., N.Y.C.; King Trendle Broadcasting Corp., Detroit; North Central B.S., St. Paul, Minn.; New York B.S., Inc., N.Y.C.; Oklahoma, Oklahoma City; Pennsylvania Broadcasters, Harrisburg; Pennsylvania, Phila.; Quaker, Phila.; Texas State, Fort Worth; Virginia B.S., Richmond; WLW Line Group, Cincinnati; Wisconsin Radio Network, Fond-du-lac; Yankee, Boston.

According to Morris E. Siegel, director of evening and continuation schools, there has been a gain of 20% over last year, in enrollment in the New York City vocational high schools, with a "tendency toward 'romantic-sounding' courses, such as radio, television and electrical engineering," to quote the *New York Times* last month. Can it be that the students feel that these "romantic-sounding" fields offer better prospects of advancement than some of the less romantic-sounding, but long over-worked fields?

As a means of helping reduce casualties in the Alps, it has been suggested that *transceivers* (combination transmitters-receivers) be installed at various points, all working on a common, "emergency" wavelength, stated *Practical and Amateur Wireless* (London) last month.

Radio-equipped balloons helped detect huge, fishhook-shaped streaks of air, each one often 1/3 the breadth of the United States and as many as 20 or 30 of them being detected in one day, just under the stratosphere, according to Dr. C. G. A. Rossby, of Mass. Inst. of Tech. Last month he described these new "controls" of weather to the 4th Int'l. Congress for Applied Mechanics, convened at Cambridge, Mass.

According to a *United Press* report from Marshfield, Ore., last month, radio will soon be used to help the sardine fishermen. A fish scout flying far out over the Pacific Ocean will radio information to the following fleet concerning any schools of fish he spots.

Last month, Bell Labs. announced a direction indicator for airplane dispatchers. The various directions from which up to 10 airplanes are sending radio signals are indicated on the end of a cathode-ray tube!

"Some guy ran away with my wife and took my radio," reported a man to Desk Sergeant Harold Reams at the San Diego, Calif., Police Headquarters, last month.

"Any idea where they went?" queried the police official.

"I don't care where they went," was the astounding reply. "but I want my radio back. It cost me \$65." (He apparently prizes the ability to turn the loudspeaker off when he wants to!—*Editor*)

Newest in the bag of tricks of Dr. Ross, magician, was Philco's Mystery Control—that Aladdin's lamp-like box which, when given a mystical, circular rub, causes radio programs to flit through a remote radio set and out of its loudspeaker. Last month, Dr. Ross added the Control to his prestidigitatorial repertoire as part of a publicity stunt for Wanamaker's, N. Y., dept. store.

Static-free and interference-free ultra-highfrequencies which have been set aside by the Federal Communications Commission for the exclusive use of education, enable as many as 1,500 stations, each with a range of 3 to 15 miles, to be operated on a single wavelength, reported Harry A. Jagers, representing the U. S. Office of Education, in addressing the XI Institute for Education by Radio, held at the Ohio State University in Columbus. Only Cleveland (Ohio) has so far applied for one of these ultra-highfrequencies, but a "Radio Workshop" was scheduled to be a feature of the National Music Camp at Interlochen, Mich., with Wm. D. Boutwell, director of the Educational Radio Project of the U. S. Office of Education, in charge; purpose of the 'Shop: to offer practical training in radio programming and studio engineering, and to instruct educators how to apply for, establish and operate an ultra-highfrequency station for educational use!

Radio-Craft pauses to ask: Why is it necessary to "train" people in such work, when expert radio men are being put on relief rolls for lack of work?

Chancellor Hitler met reverses on the air, last month, when he broadcast from Nuremberg. A "screaming, whistling, throbbing interference," which began soon after Hitler started his speech, ruined reception of the program everywhere. Broadcasts from London, Paris and other capitals also felt the effect of the interference. Reports from Vienna and Warsaw laid the blame at the door of a Russian station.

On 15 minutes' notice, B.B.C. is now prepared to go on a war basis—that is, nothing but news at 15-minute intervals, reported the *N. Y. Times*, last month.

ACA News, houseorgan of the communications wing of the C.I.O., the American Communications Assoc., last month presented to Chief Engineer Jett of the F.C.C. a list of suggested changes, in the proposed new rules and regulations governing commercial radio operators licenses. "in the best interest of the public, the licensed commercial radio operators and the industry." ACA's clause No. 4 suggests: "A 21-year age limit for applicants for commercial radio operator licenses."

The program coincident with burial of the Westinghouse "Time Capsule"—800-lb. envelope being "mailed" to people living 5,000 years from now—Friday, Sept. 23, was broadcast over the networks. Books describing the Capsule, and its content of items representing the civilization of today, and giving directions for its discovery are being left in libraries all over the world.

An ankle cue-buzzer is worn by Jean Miller, a Canadian girl on B.B.C.'s regular television program. Vibrating at 50 times per second, "it tickles," said Jean last month, but being neither seen nor heard, is better than the flashing light previously used, and which distracted viewers.

In Germany, telly engineers are said to be working with 771-line pix, 6 ft. high. Also said to be far ahead of Britain.

In England, television courses (given by Pye, Ltd. London) are booming.

2,500 dealers are expected to attend the RMA Television Convention at the annual show, "Radiolympia," on the Tight Little Isle.

WIRE-TAPPING

PICTURE a Brooklyn magistrate with earphones clapped tightly to his ears and his courtroom audience listening intently to the blaring of exciting voices from a loud-speaker—wire-tapped evidence on a wax disc—damning, irrefutable. Does evidence obtained by wire-tapping violate the peoples' rights against unreasonable search or seizure?

New York Governor Lehman says wire-tapping "is a vicious weapon that dictatorship invokes against the individual rights of its citizens". Any proposal to eliminate police-obtained wire-tapped evidence from court, says New York District Attorney Dewey, "will have the single effect of protecting murderers, gangsters and kid-nappers". So there you are! Wire-tapping is permitted in New York State, forbidden by the Federal Government.

Meanwhile, District Attorney Dewey's office, which used tapped telephone conversations as evidence (and accepted as such by Supreme Court Justice Peckora) in the celebrated Hines trial, last month obtained the indictment and arrest of 3 men—including C. Arnold Austin, head of Speak-O-Phone which manufactured the wire-tapping equipment Dewey used—on charges of illegal wire-tapping!

Laugh of the month was the OK by the New York State Constitutional Convention, at Albany, of a constitutional amendment which says, in effect, "naughty, naughty, mustn't wire-tap,—mamma spank," but which provides no means for applying the spanking!; and, once the evidence is obtained, provides no means for stopping use of the evidence thus "illegally" obtained!

Everything in Radio

SEND FOR ALLIED'S **AT LOWEST PRICES!**
180 Page 1939 CATALOG

SETS! 62 NEW 1939 *Knights* AT AMAZINGLY LOW PRICES!

DEALERS!—see the new sensational Knight Radios in ALLIED'S 1939 Catalog. 62 models for every purse and purpose—new advanced features, new beauty, finer tone, better performance—at new low prices. Sets from 4 to 16 tubes—many with Push-Button Tuning; new "Tiny Knights," 1½ Volt battery sets; new AC, AC-DC, 6 Volt, 32 Volt and auto models. Also, see the most extensive line of phono-radio combinations, phonographs, and record players in radio—all priced to bring you greater savings and bigger profits! Send coupon for your Free ALLIED Catalog!



BACKED BY ALLIED'S IRONCLAD GUARANTEE
All Knight Radios are covered by ALLIED'S Ironclad guarantee—it gives you fullest protection!

PARTS! KITS!

SERVICEMEN!—All standard lines of test equipment—Rider's Ch analyzer, Rural Meter, etc.—and over 14,000 exact duplicate and replacement parts.

RADIO BUILDERS!—We can supply Free Parts Lists covering any kit described in this or any other magazine. Write!

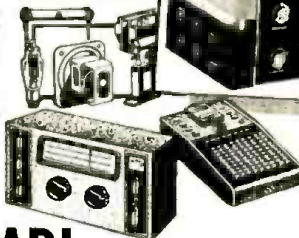

P.A. THAT SET NEW VALUE STANDARDS

SOUND MEN! See the revolutionary new Knight Sound Systems. 8 to 65 watts—standard and deluxe jobs—for portable or permanent installations. New 30 Watt Mobile Systems. Electric Guitar Amplifier—and the most complete line of recording equipment in any catalog!

TESTERS!

New Push-Button Equipment—makes your servicing easier and quicker.

Fastest service, lowest prices, highest quality—these are the watchwords which have made ALLIED Radio's Leading Supply House!

HAM GEAR!

AMATEURS!—A complete Ham section, packed with high-grade, low-cost Short Wave gear. See the new National N-14 and 510, Hallicrafters "Diversity" and "5-10," Howard 450, 440 and 430, and Sargent "30 Streamliner" receivers; and the National 600 Watt, Hallicrafters "11T," and "Pee-Wee" transmitters. Write to us about our painless Time Payment Plan—the most convenient in Radio!

Send for your Free copy of the 1939 ALLIED Catalog today! You'll save and profit with our low prices and speedy service. It includes Everything in Radio—thousands of money-saving, profit-making items for every radio man. It's copiously illustrated so that you can see what you buy; skillfully indexed so that every item is at your fingertips. Send the coupon for Radio's Buying Guide!



FREE CATALOG

ALLIED Radio

ALLIED RADIO CORP.
Dept. 2-M-9
833 W. Jackson Blvd., Chicago, Ill.
Send me your Free 1939 Catalog.

Name
Address
City State

OVER THIRTY-FIVE BIG OFFERS!

The Classified Section which appears on Pages 380 and 381 contains many interesting offers and services. **TURN TO IT NOW . . . READ IT FROM START TO FINISH!**

LEOTONE Specialists for 17 Years in CONES and FIELD COILS and HARD-TO-GET PARTS

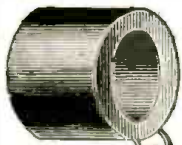

Field coils on bakelite bobbins for all dynamic speakers.



Curvilinear and parabolic cones for ANY cone-type speaker.

FREE: Send for No. 33, one of the most interesting 36-page Catalogues ever compiled for Dealers and Servicemen. Contains everything on cones and field coils—the balance on hard-to-get parts. A real encyclopedia of replacement parts seldom seen in print elsewhere.



Stromberg-Carlson replacement part—Mounting Collar Hub.

LEOTONE RADIO CO.
63 Dey Street, New York, N. Y.

YOUR FUTURE IN RADIO TELEVISION

These growing industries need trained men for sales, service, operation. Your chance for employment and advancement depends on thorough training. National Schools offer you time-tested training. Complete, modern facilities and equipment in the largest trade school in the West.

Send for free booklet that shows how you can prepare for these opportunities.

FREE BOOK

NATIONAL SCHOOLS
4000 S. Figueroa Street, Los Angeles

NATIONAL SCHOOLS, Dept. RC12, Los Angeles
Please send free Radio and Television Booklet.

NAME AGE
ADDRESS
CITY STATE

Please Say That You Saw It in RADIO-CRAFT

SERVICING QUESTIONS & ANSWERS

(Continued from page 339)

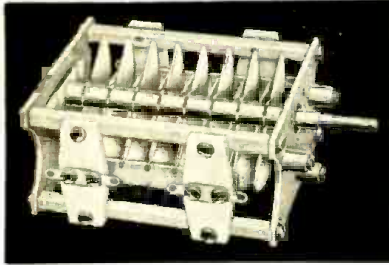

NEW "TC" TRANSMITTING CONDENSER

Hammarlund's new "TC" transmitting condensers include many outstanding and exclusive features. They are available in a wide range of capacities and voltage ratings with both single and dual stators. Wide plate spacing permits their use in transmitters up to 1 kw. input. Special full floating bearing construction eliminates binding and twisting. Heavy polished aluminum plates with rounded edges increase efficiency. Write for bulletin describing special rotor and contact construction and other details.

HAMMARLUND MFG. CO., INC.
424 W. 33rd St., N.Y.C.

RC-12

() Please send "TC" bulletin

Name

Address

City State

Canadian Office: 41 West Ave. No.,
Hamilton, Ont.

HAMMARLUND

Size of box: 12½"x8½"

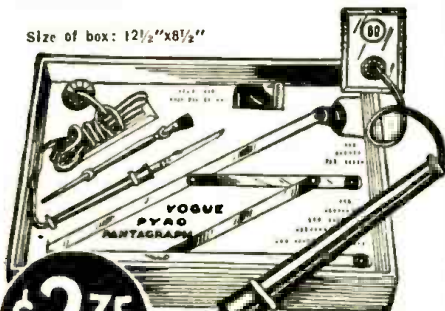

Shipping Wt. 3 lbs.

\$2.75

VOGUE

**Pyro
Pantagraph**

With this PYRO PANTAGRAPH turn leisure time into profitable hours. Make money a novel, easy way—"Burn Your Way to Extra Dollars with Pyro Pantagraph." This electrical outfit is especially designed for burning designs permanently on Leather, Wood, Cork, Gourd, Bakelite, etc. Simply plug the Pyro-electric pencil in any 110-volt AC or DC outlet and it is ready to be used. Plug and cord furnished as part of equipment.

By the use of a special Pantagraph included in the outfit, any design may be reproduced either in original, reduced or enlarged form. Outfit consists of: one Pyro-electric Pencil; one Pantagraph; three hardwood plaques; one bottle of Varnish; one Brush; one tracing tip and four-page instruction sheet.

Outfit will be forwarded by Express Collect if not sufficient postage included with your order.

WELLWORTH TRADING COMPANY
558 W. WASHINGTON BLVD., Dept. RC-12, Chicago, Ill.

the other, to succeeding stages. What would be your explanation?

(A.1) The method of placing a finger lightly on the control-grid of a tube to determine an oscillatory condition is one test universally employed, although not always effective.

Since grid current flows in the control-grid circuit of an oscillating tube, the insertion of a milliammeter or microammeter of suitable range into the control-grid circuit will indicate the condition. However, the capacitive effect of the meter leads or the inductive effect of the meter will often tend to overcome weak oscillation and defeat the purposes of the test. A vacuum-tube voltmeter of low input capacity, such as those with meter tube extended, is generally employed to detect oscillation in a tuned stage by measuring the A.C. voltage drop across the tuned circuit, with no signal applied. In the case of a screen-grid tube, oscillation may be noted readily by fluctuating screen-grid current.

The additional capacity which is reflected into the control-grid circuit of an R.F. tube when an antenna is connected to a receiver, will often produce an oscillatory condition, since this added capacity increases the ability of the tuned circuit to build up sufficient energy to set up oscillations. This is true of many receivers where an R.F. stage, whether by design or accident, is operating at the "threshold" of oscillation to improve sensitivity.

Improper operating potentials may also cause this state. Due to interaction between stages, oscillation in one stage often affects another stage to produce the same oscillatory condition. Floating shields, open-circuited bypass condensers or bypass condensers with insufficient capacity are the major causes.

(Q.2) What is the cause of oscilloscope patterns such as these (Fig. Q.95-2.) occurring during alignment of I.F. amplifiers?

A Supreme 981 frequency-modulated signal generator and Clough-Brenzle oscilloscope were used in the test, the time base voltage from the generator being fed to the horizontal plates of the oscilloscope through the phone jack on the side of the instrument so as to make use of the amplifier. Connections from the signal generator were made to the 1st-detector grid and chassis, and from the oscilloscope across the 2nd-detector diode load resistor.

The 2 images could not be made to coincide by adjusting the I.F. trimmers, but would elongate or contract vertically without changing their relative positions. That is, they could not be made to move toward each other so as to overlap. There was, however, a definite maximum signal strength to which the trimmers could be adjusted. I have not had this trouble on other receivers, and so I am not laying the difficulty to the testing equipment.

(A.2) In aligning the I.F. stages of a receiver with oscilloscope and frequency-modulated generator, patterns such as described may be the result of the generator frequency being adjusted incorrectly for the I.F. stages in question. We would suggest that I.F. transformers be peaked first, without frequency modulation, in the usual manner. Then, with frequency modulation, adjust the generator frequency slowly until the forward and reverse traces appear on the screen with highest points of the 2 waves coinciding as much as possible. Of course, the precaution of over-comeing A.V.C. action on I.F. stages is important. Another suggestion is that of making adjustments with signal generator connected to grid of last I.F. stage and then working back to 1st-detector.

INTERMITTENT DISTORTION

(96) Everett C. Reid, Windsor, Ont., Canada.

(Q.) I have a job on a Stromberg-Carlson 42B (25-cycle) receiver using 3-35's, 1-21K, 1-57, 2-56's, 2-2A3's, and a 5Z3. The set originally had a case of intermittent distortion which could be cleared up by rapping the volume-control knob. While working on it distortion became sustaining at resonance.

Here are a few symptoms and odd things I noticed: All voltages and tubes check OK; coils and transformer windings were checked for continuity and seem OK, no leads were grounding; distortion is decreased 50% when 0.04-mf. condenser from grid-return of mixer tube to ground is cut out of circuit; set will operate without distortion when using a small aerial (3 ft.) and

a good ground; volume control was checked but not substituted-for; distortion is removed when a 10 mmf. condenser is run from plate of oscillator to ground, and dial retuned to resonance, but sensitivity of set is reduced in this condition.

(A.) The symptoms described in connection with a Stromberg-Carlson receiver are decidedly due to insufficient A.V.C. action. The fact that distortion may be cleared by removing the grid filter condenser in the 1st-detector control-grid circuit, or by the use of a very short aerial points definitely to this conclusion.

We suggest replacement of all grid filter condensers in the R.F., I.F. and 1st-detector control-grid circuits. Excessive leakage in these units nullifies the action of the A.V.C.

R.F. AND A.F. OSCILLATION AND WEAK RECEPTION

(97) W. G. Fenn, Mission City, B. C., Canada.

(Q.) The set in question is an RCA Victor Model R22A. It came to the shop in an oscillating condition with weak, distorted signals and motor-boating. Upon analysis, plate voltages, etc., appeared normal, except for plate currents on A.V.C.-controlled tubes. Plate current on these tubes was practically nil. Removal of the A.V.C. restored plate currents to above normal. Suspecting trouble in the A.V.C. section this part was analyzed thoroughly. Failure to find trouble there, led to all resistors and condensers in the set being tested. No defects could be found anywhere, including tubes.

About 2 months before this trouble appeared, the choke (reactor) in the plate circuit of the 2nd-detector had been replaced with an RCA exact-replacement part. The set had not shown any ill effects from this replacement.

As a last resort I tried bypassing various circuits and discovered that a 0.12-mf. condenser from the cathode of the 2nd-detector to ground eliminated the condition and allowed the A.V.C. to function normally. There are several points bypassed to ground that would allow the set to work: the high-voltage lead supplying the I.F. transformers is another.

Since repairing the set the last time the customer tells me that ever since the reactor had been replaced the machine seemed to be subject to a little roughness. The only conclusion I can come to, is that some sort of oscillatory condition arose in the replacement part. The condition came on quite suddenly. The I.F. for A.V.C. had a cathode bias resistor of 850 ohms, which I replaced with a 1,500-ohm resistor. This improved the performance of the set.

Have you ever encountered a trouble of this kind in this model of machine?

I will await with interest your conclusion of the troubles encountered here.

(A.) The RCA Victor model 22A is not included in our files. From your description of the receiver, however, it would seem that the model in question is similar to the RCA Victor model 78 or 78A.

The fact that the plate currents of the A.V.C.-controlled tubes were very low would signify A.V.C. trouble wherein excessive bias voltage was generated. This undoubtedly was due to faulty resistors in the A.V.C. diode circuit of the 56 or 55 (78A) tube. Suggest that these components be checked for correct resistance value.

When the bias resistor for the I.F.-A.V.C. amplifier tube was changed to a higher value, the I.F.-A.V.C. was rendered less sensitive, thus, in turn, producing lower A.V.C. voltages, which brought the plate currents of the A.V.C.-controlled tubes to, or near, normal. Replace the grid filter condensers in the R.F. mixer and I.F. circuits. Check screen-grid and plate voltages carefully, and replace all resistors in the voltage divider circuit which deviate more than 10% from stated values. This should clear up your difficulty.

EXCESSIVE HUM

(98) J. Sidney Stewart, Sydney Mines, N. S., Canada.

(Q.) Have an Atwater Kent radio receiver model 82 for repair: the trouble with the set is excessive hum. When I remove the last output tube, a type 47, the hum is still there. Filter condensers in power pack are OK. The speaker field tests around 2,000 ohms. Please help me

clear up this hum as it has me puzzled. This set uses the following tubes: 1st-det., 35; I.F., 35; 2nd-det., 24; osc., 27; cont., 24; A.F., 47; rect., 80. Power supply is 110 V., 60 cycle.

(A.) When hum is heard with the type 47 output tube removed from your Atwater Kent model 82 receiver, it is very possible that the power transformer is at fault. Try tightening the entire assembly so that the frame and laminations cannot vibrate. Check the first filter condenser case (negative) for a grounded condition. With speaker plug in position, a reading of approximately 2,000 ohms should be obtained.

Should hum still be heard with all tubes removed, we suggest that you replace the power transformer.

WEAK, CRACKLING RECEPTION

(99) Howard H. Arnold, Keota, Iowa.

(Q.) I have in my shop 2 sets which are, to me, real "sticklers." One is a Motorola 5-1. Reception is very weak and a severe crackling accompanies reception. Shorting antenna-ground wires does not eliminate crackling. Shorting grid of 6D6 to ground eliminates crackling. Voltages about normal. Condensers seem OK, and a 1,400 V. "shot" did not burn any of them out.

The other set is a Silvertone (Sears, Roebuck) either No. 1652 or No. 1654. The complaint is low volume, tubes OK. Voltages approximately as they should be, but, as I have no diagram of this set, I cannot be sure about the voltages. Any information or circuit diagrams you can supply would be appreciated, and, as both sets came in as "rush jobs," promptness would be doubly appreciated.

(A.) The crackling noise experienced with your Motorola receiver suggests a defective 1st I.F. transformer primary winding. By checking the D.C. resistance of this coil, you will probably find an abnormal increase.

To determine definitely whether this coil is producing the noise condition, connect a voltmeter (1,000 ohms volt) across the primary winding, the negative lead of the meter to the plate terminal of the coil. Employ a high range of the meter at first to ascertain the voltage drop, and then use the range higher than this reading. Any fluctuation in the meter reading, coinciding with the crackling, denotes a "bad" primary.

The nominal charge for the service rendered by this department is 25c per question. For further assistance with your Silvertone receiver, kindly forward fee and re-state complaint.

OPERATING NOTES

(Continued from page 339)

denser, 735 mmf. condenser, and complete oscillator coil assembly, as suggested on manufacturer's service sheet on this model when it would fail to oscillate on or over certain parts of the dial, and still NO results.

So I disconnected the 2 leads and 0.002-mf. condenser that are fastened to the 2 lugs for the 4,200-ohm section on the candohm resistor (condenser and resistor in cathode circuit of the 36 Osc.-Det. tube) and tried various values of resistances. Oscillator would oscillate and set restored to normal operation when I would use a resistor in value from about 1,500 to 2,500 ohms. I resoldered leads and condenser back on candohm and shunted a 3,000-ohm, 1-watt resistor across the 4,200-ohm section of the candohm unit, which gave an effective value of 1,750 ohms. Set would play fine and with 36-type tubes that tested good, but would not oscillate before lowering the value of the cathode resistor. Shunting the resistor this way makes it a lot quicker and easier.

One of these same models came in for service about a month ago with the same complaint and I was unable to locate the trouble by doing all the above with the exception of changing the value of the resistor. I returned the set to its owner and he sent it to United Motors Service at Cincinnati, coming back pronounced OK, but it was still in the same condition. I got the set back myself and shunted the resistor as above and it worked perfectly, just as the others did.

This is the 7th one of these models that I have had in for service in the past 4 months with the same complaint.

FRED E. BERRY,
Berry's Radio Service

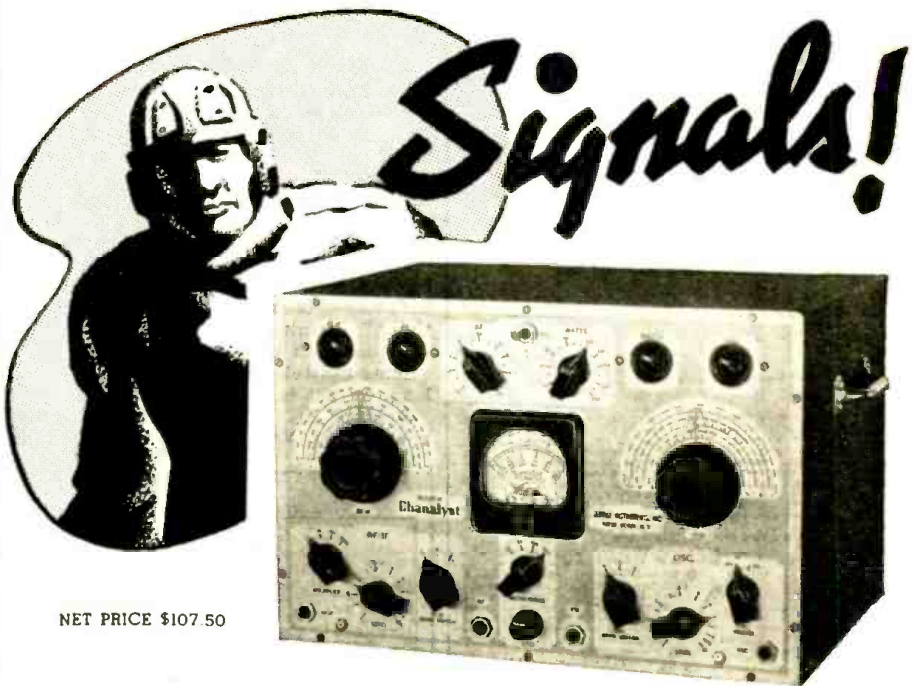

NET PRICE \$107.50

The Rider Chanalyst Follows Them Right to the Source of Trouble

In radio trouble shooting as in football the signal is fundamental. It is the thing which must be studied and followed before "scoring territory" is reached.

The Rider Chanalyst provides you with the most logical system of trouble shooting because it follows the signal right through the set. It enables you to study the condition of that signal at any point without interfering with the normal operation of the set. It leads you directly to the section — to the very part—which is causing the trouble—and this it does with a SPEED heretofore impossible.

For, the Rider Chanalyst operates without adaptors or plugs. Thus, you can follow the signal through the set as easily and as fast as you can move a probe from one point to another.

The multitude of tests made possible by this instrument (which involves no unknown principles of radio) are contained in a 16-page Free booklet we have prepared for you. Write for this now, and arrange today with your jobber for a Free demonstration of the time saving instrument which is the sensation of the servicing field!

Free
16 PAGE
BOOKLET
SENT ON REQUEST



JOHN F. RIDER

in whose Successful Servicing Laboratories this revolutionary instrument was developed.

SERVICE INSTRUMENTS, Inc. 404 FOURTH AVE., NEW YORK CITY

The **RIDER**
Chanalyst

CASH IN ON YOUR SPARE TIME!
300 WAYS TO MAKE MONEY

SOLD ON A MONEY-BACK GUARANTEE!

68 PAGES

MAIL ORDER PLANS
TESTED MONEY MAKERS
BUSINESS SECRETS
SUCCESS SCHEMES

25c
PER COPY

Remember — your money back if not satisfied!

IN "CASH IN" you will find over 300 ways to make money—dozens of profitable tested mail order plans, confidential business secrets, dozens of practical tested formulas, sources of supplies, successful, and honest tested schemes—many actual experiences of men who have started on the proverbial shoestring—with less than \$10 capital.

Buyers of This Book Tell Us—

"Your book is as good if not better than others selling at \$1.00." George Brunet, Montreal, Canada.

"CASH IN is the best value I have yet to see in the mail order field." Lawrence Fox, Brooklyn, N. Y.

"CASH IN" contains 68 pages of tested ideas covering every type of full- or spare-time enterprise—it is really a "masterpiece" in business ventures—over 40,000 WORDS IN THE TEXT.

Sent POSTPAID anywhere upon receipt of twenty-five cents in U. S. stamps or coin.

NATIONAL PLANS INSTITUTE 246-R FIFTH AVENUE NEW YORK, N. Y.

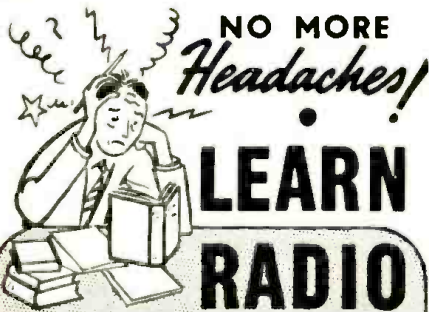

LEARN RADIO

this Easy Way

Radio is a "cinch"—when you use Ghirdard! He'll give you a complete radio education in just 1 handy volume. A miracle of condensation—for it gives you a sound and thorough training in RADIO, electricity, sound, television, cathode-ray tubes, etc. Everything you want right here. Yet it's the quickest, simplest, easiest home-study course you could pick. No "mush" to puzzle you. No preliminary knowledge necessary. Just spend a few minutes a day with the book. Before you know it, you'll find yourself qualified to hold down a good-paying radio job.

\$4

HERE'S WHAT YOU GET:

- Sound—Electrical Theory and Principles—Electrical Currents
 - Electro-magnetism—Transformers—Inductance—Condensers—Measuring Instruments—Radioactivity—Broadcasting—Receiving—Vacuum Tubes—Amplification—Superior—Coils—Speakers—Receivers of all types
 - Short-Wave—Auto-Radio—Aircraft Radio—Public Address—Photoelectric Cells—Cathode-Ray Tubes—Television—Testing and Servicing—Sound Motion Pictures—Reference Tables.
- Radio schools and students use this more than any other radio book in the world. Will it work for YOU? YES!—send for it and try it right now—with the coupon help. You don't risk a cent. Got set to go!

RADIO PHYSICS COURSE

MAIL NOW

RADIO & TECHNICAL PUBLISHING CO.
45 Astor Place, New York, Dept. RC-128
I will send me one copy of
Radio Physics Course, with 10-day money-back guarantee.

NAME _____ STATE _____
ADDRESS _____
CITY _____

972 Pages, 508 Illus.
556 Review Questions.

Please send free descriptive literature.

Elgin 700 Tube Tester

Uses approved emission circuit—Tests all tubes to date—Jewelled D'Arsonval meter—Inter-element short and leakage test.

The greatest buy ever offered in a tester of this type. Built into an attractive reinforced steel cabinet. Available in portable or counter model. Portable model includes cover, \$55 extra.

Serviceman's Cost **\$10.40**



801A AC-DC Uni-Tester

Offers 13 accurate tests with a jewelled 0-1,000 ohm per volt foundation meter. Built for accuracy—and not for price. Readings available 0/5/50/500/1000 volts A.C. or D.C. 0/5/50/500 D.C. milliamps, and 0/500/500,000 ohms. Its compactness, plus its ability to determine measurements accurately, puts this instrument at the head of its class.

Serviceman's Cost **\$7.95**

Send for 1939 Test Equipment Bargain Bulletin
TRY-MO RADIO CO., INC.
85 CORTLANDT ST. NEW YORK CITY

NOVEL IDEAS IN RADIO SETS

(Continued from page 345-346)

from directly in front (as illustrated). Feature No. 2 is the pushbutton design. Pushing a button causes an arm to slide along a curved surface; this forces the main tuning condenser to turn, as shown in Fig. 4, and eliminates need for more than 1 set of trimmers. Each of the 4 buttons may be set from the front of the radio.

Feature No. 3 is the use of "a certain amount of fixed regeneration" in the 6D6 R.F. stage "to improve selectivity and sensitivity." Circuit oscillation (only if a too-small antenna is used) is controlled by the volume control; antenna supplied is 25 ft. long. Output is 1 watt.

Feature No. 4 is the dual side control-knob design. Volume and off-on operations

are controlled by a knob on the left side of the cabinet; and manual tuning, across the entire range of 540 to 1,720 kc., is controlled by the right-side knob.

TOM THUMB SUPER.

THE superheterodyne illustrated in Fig. E has the distinction of being one of the very first receivers to utilize the new small-space "Bantam" tubes (described in May Radio-Craft) in a commercially-available receiver. The schematic circuit is shown in Fig. 5. Complete receiver measures only 4½x5½x7½ ins. long, yet the output is 2.5 watts! This No. 950, 4-tube set is manufactured by Automatic Radio Mfg. Co.

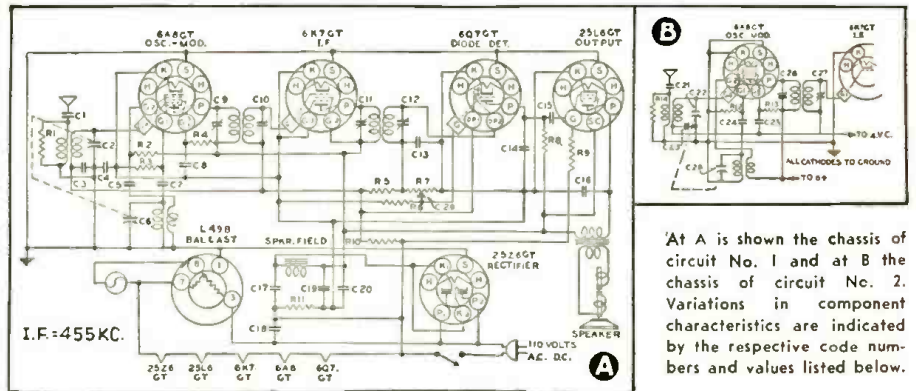

- CONDENSERS:**
C15—0.01-mf.
C29—0.01-mf.
C21—0.01-mf.
C23—0.05-mf.
C20—0.05-mf.
C25—0.05-mf.
C16—0.02-mf.

Fig. 1. Schematic diagram of Majestic Set.

- C18—0.02-mf.
C24—50 mmf.
C13—250 mmf.
C14—100 mmf.
C17—40 mf.
C19—16 mf.
C26—TRIMMER
C27—TRIMMER
- C11—TRIMMER
C12—TRIMMER
- RESISTORS:**
R11—100 ohms
R12—50,000 ohms
R13—15,000 ohms
R8—0.5-meg.

- R9—0.4-meg.
R5—2 megs.
R10—5 megs.
R6—15 megs.
R14—10,000 ohms
R7—0.5-meg.

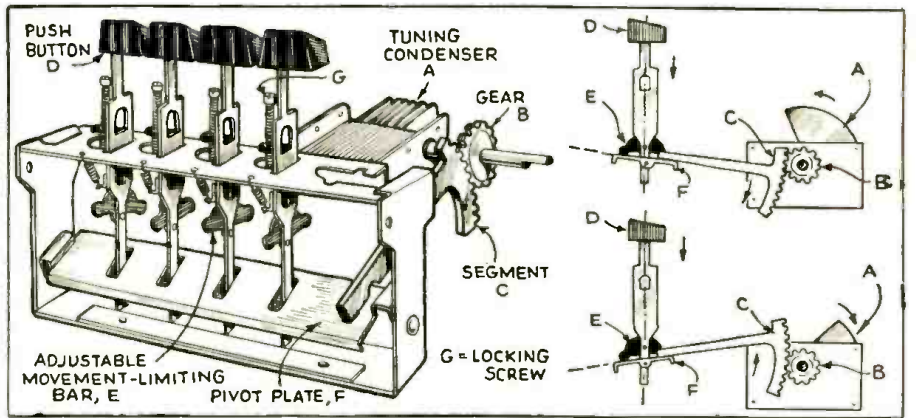

Fig. 4. Details of Crosley's inexpensive and simple mechanical pushbutton tuning system.

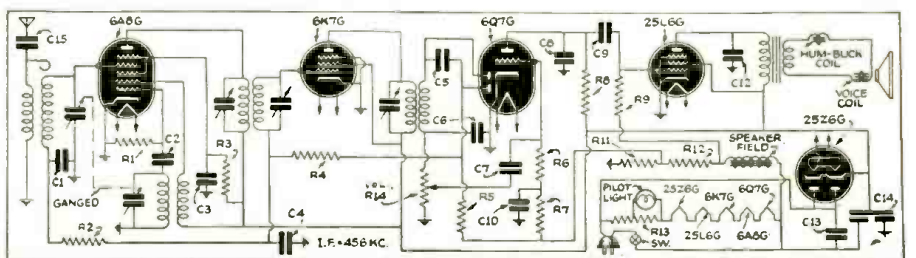

Fig. 5. Schematic diagram of the TOM THUMB broadcast receiver.

- CONDENSERS:**
C1—0.05-mf.
C2—0.0001-mf.
C3—0.05-mf.
C4—0.05-mf.
C5—0.0001-mf.
C6—0.0002-mf.

- C7—0.01-mf.
C8—0.0002-mf.
C9—0.01-mf.
C10—0.1-mf.
C12—0.01-mf.
C13—0.05-mf.
C14—20-20 mf.

- C15—0.006-mf.
- RESISTORS:**
R1—50,000 ohms
R2—100,000 ohms
R3—25,000 ohms
R4—500,000 ohms
R5—500,000 ohms

- R6—150,000 ohms
R7—1 meg.
R8—250,000 ohms
R9—500,000 ohms
R11—30 ohms
R12—100 ohms
R13—line cord
R14—Vol. cont.

(Concluded on opposite page)

Please Say That You Saw It in RADIO-CRAFT

ACCURACY TEST INSTRUMENT SAVINGS

You get both with RCP TUBE TESTERS

Seldom is the serviceman offered these two wanted features in one instrument. RCP does it with every test instrument in its line! Accuracy you can rely on to stay, prices surprisingly low. Together, they say: now you can afford the best in tube testing instruments. Write today for latest folder describing entire RCP line.

DEPENDABLE MULTITESTER • UNIVERSAL MODEL 409A

A real professional job employing exclusive system of A.C. measurements assuring accuracy at all frequencies. Ohmmeter, low range scale reads only 2 ohms at center. Shunts and multipliers calibrated 2% accurate. 4 range D.C. voltmeter reading to 1000 volts at 2000 ohms per volt A.C. voltmeter, 4 range, to 1000 v. D.C. microamps. 0-500. 3 range D.C. ma. meter to 500 ma. D.C. ammeter to 5 amps. 4 range ohmmeter to 7.5 megs. 4 range db. meter - 12 to + 54 db. Output meter same as A.C. vm. Can be used on either D.C. or A.C. frequency. Economically priced complete as illustrated.

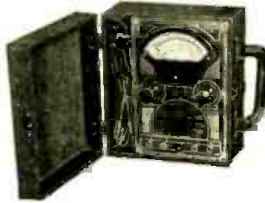

409P as illustrated \$19.45
Model 409C open faced (without cover) \$17.95

SIGNAL GENERATOR • MODEL 701

NOW AT NEW REDUCED PRICES

Direct reading, full vision A.C. all wave generator. 400 cycle sine wave modulation. Provides for unmodulated and externally modulated signal. Special lead coated steel shielding. Coil, attenuator and R.F. circuits individually triply shielded. Continuously variable from 25 kc. to 90 mc. Exceptionally fine attenuation, calibrated in approximate microvolts.



LOWEST PRICED HIGH QUALITY GENERATOR AVAILABLE.
MODEL 701 FORMERLY \$29.95 NOW \$25.95

Other instruments in the complete RCP line available from \$5.95 to \$59.25. Carried by all leading distributors. If not stocked by your local jobber, write direct. Clip convenient coupon for your copy of the new RCP catalog. Absolutely free.

RADIO CITY Products Co. Inc.
88 PARK PLACE NEW YORK CITY

FREE

RADIO CITY PRODUCTS CO., INC. [RC1238]
88 PARK PLACE, NEW YORK CITY

Rush me free new descriptive catalog on Dependable Instruments.—ENCLOSED FIND M.O.—CHECK—SEND C.O.D.—MODEL—

Name
Address
City State

PASTE COUPON ON PENNY POSTCARD

NOVEL IDEAS IN RADIO SETS

(Continued from opposite page)

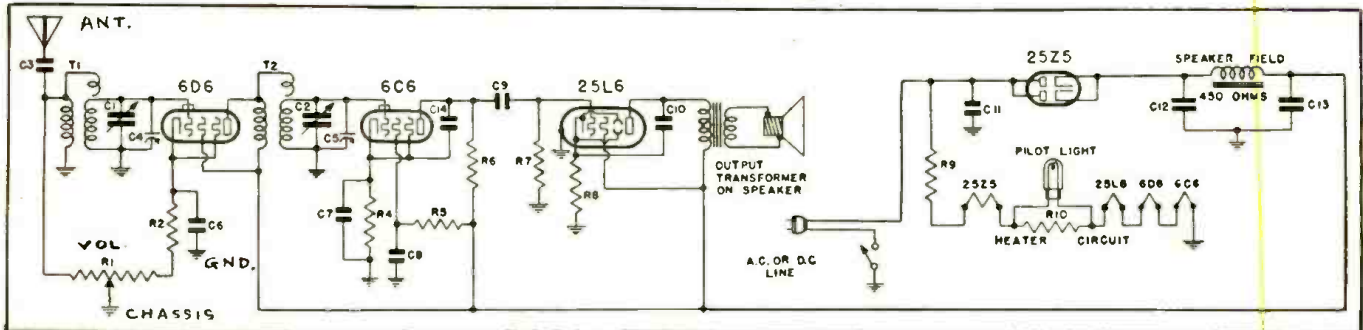

CONDENSERS:
C3—0.001-mf.
C4—TRIMMER
C5—TRIMMER

C6—0.1-mf.
C7—0.25-mf.
C8—0.1-mf.
C9—0.02-mf.

Fig. 2. Schematic diagram of Emerson Set.
C10—0.03-mf.
C11—0.1-mf.
C12—16 mf.
C13—16 mf.
C14—100 mmf.

RESISTORS:
R1—75,000 ohms

R2—310 ohms
R4—0.25-meg.
R5—2 megs.
R6—0.5-meg.

R7—0.5-meg.
R8—110 ohms
R9—185 ohms
R10—40 ohms

U. S. ARMY P.A. SYSTEM HAS 1-MILE RANGE!

(Continued from page 340)

for 5 hours to explain to a huge audience the maneuvers performed on the battlefield by regular army troops.

Two collapsible steel tripods 20 feet high are used to support the six 100-watt speakers in groups of 3. The tripods can be arranged and the loudspeakers can be adjusted to provide ample coverage of any area. All equipment is carried within the truck, including a sectional steel ladder for mounting the tripods.

The 2 high-fidelity speakers mounted in the truck are used for covering crowds of 5,000 or fewer persons; and in instances where extremely high-fidelity reproduction is a primary consideration and sound area

coverage secondary.

The unit is styled by Signal Corps engineers as being one of the largest and best-equipped mobile systems in the United States. It is equipped with a powerful RCA Victor radio receiver, which is capable of amplifying broadcasts over the loudspeakers; it has phonograph turntables for playing records through the speakers, and a recording device has been included to permit recording and instantaneous playback.

The view at A of the mobile Public Address system shows it packed in the truck for traveling. Four of the six 100-watt loudspeakers, which are mounted on collapsible steel tripods when the system is set up,

are shown, as is the gasoline motor-driven generator (center) which supplies power for the system when an outside source is not available. In the background can be seen the 2 high-fidelity speakers which are mounted permanently in the truck and operate through large grilles on the sides. Against the roof can be seen a sectional steel ladder which is used to mount the speakers. At the front of the truck (not shown) are the radio receiver, and sound recording and playback system.

At B the system is shown as it was set up for President Roosevelt's speech at Gettysburg. Three 100-watt power speakers are shown on each tripod.

Please Say That You Saw It in RADIO-CRAFT



"A MILLION DOLLAR BABY!"

THAT DOES A MAN-SIZED JOB

That's the way servicemen are referring to the new Sprague ATOMS! For ATOMS (midjet dry electrolytics) have all the quality of a real "million dollar baby." They're backed with all the engineering resources of the world's largest manufacturer of quality condensers. They're built better, more scientifically than larger old-style units they're designed to replace. And they're selling like hot cakes among those who know them best—wherever the demand is for really good condensers at rock-bottom prices.

SAVE TIME • MONEY • SPACE

Made by an exclusive Sprague etched-foil process, ATOMS are available in all standard capacities including DUAL COMBINATIONS. You save real money. If you haven't tried them yet—TRY THEM NOW!

SPRAGUE PRODUCTS CO.
North Adams, Mass.



SPRAGUE ATOMS
"Mightiest Midjets of All!.."

World's Lowest - Priced Quality Test Units

14 Ranges \$7.90
A.C. and D.C.

THE Bernard Econometer is the outstanding miniature instrument. Using a full-sized 2" meter, 0.1 ma., it is unsurpassed for smallness and actually fits in your pocket. Only two controls. D.C. at 1,000 ohms per volt; 3-volt battery (renewal cost 10¢) self-contained. The scale is unusually extended and easy to read.

Ranges:
0-5-10-100-500 volts d.c. at 1,000 ohms per volt
0-5-10-100-500 volts a.c., using self-contained copper-oxide rectifier.
0-1-10-100-1000 ma. (one amp.) d.c.
0-400 ohms and 0-250,000 ohms.

Bernard Econometer, Model 383, shipping weight 3 lbs.

A Complete Line

We manufacture a choice line of up-to-the-minute test equipment, including a push-button tube checker, a signal generator, a giant multimeter with 8 1/2-inch meter for wall, shelf or bench use; a pocket sized 5,000-ohms per volt and other apparatus, all at the world's lowest prices for such quality equipment. Get amazing details by sending for Catalogue "G".

Lowest-Priced but Priceless

BERNARD

H. J. Bernard, 319-G Third Ave., Brooklyn, N. Y.
SEND FOR CATALOGUE "G"

TRAFFIC LIGHTS IN YOUR CAR BY RADIO!

(Continued from page 329)

visual signals for control of trains under poor conditions of visibility when light cannot easily be seen.

The system may also find application in preventing rear-end collisions by installing the transmitting units at the rear of all trains for control of following traffic when within a given danger zone.

Future application to highways will be dependent on the extent to which automobile manufacturers and police or highway departments will cooperate in installing the required receiving and transmitting equipment. As in the development of television and facsimile services the problem is complicated by economic rather than technical factors.

The MARCH OF TIME episode in which the functioning of the Halstead invention is portrayed discusses, in addition, other highway engineering achievements and theories designed to make tomorrow's highway safe for motorist and pedestrian alike. The film, released to 8,200 U. S. theatres, it is estimated will in the next 4 months be seen by 23,000,000 people.

Halstead has been developing his systems for a number of years and is at the present time perfecting equipment for ultimate use as portrayed in the motion picture episode mentioned above.

To conclude, we quote as follows from the Oct. 10, 1938, issue of *Automobile Topics*:

Once radio safety becomes an accomplished fact in the form of an accepted attachment, it doubtless will spread rapidly. Mass production in answer to mass demand should bring it within the purchasing power of every car

owner (\$5 per set, is one estimate). It would create a new industry that should bring a safer America than most motorists have known.

The Wavelength Ranges of Apparatus, Radiations, and Transmission Effects

Wave length			Generators and Detectors
Meters	Microns	Angstroms	
10	10 ⁶	10 ¹¹	Vacuum tube Local energy Regenerative oscillators Backwave oscillators Magnetron oscillators Spark oscillators Homocircuits of spark oscillators Special photo cells Fog piercing wave length Near vision Visible light Far ultraviolet Gamma rays and x-rays
1	10 ⁵	10 ¹⁰	
1	10 ⁴	10 ⁹	
0.1	10 ³	10 ⁸	
0.01	1,000	100,000,000	
0.001	100	10,000,000	
0.0001	10	1,000,000	
0.00001	1	100,000	
0.000001	0.1	10,000	
0.0000001	0.01	1,000	

The above table is reproduced from "Below 10 Meters," by James Millen, by special permission of the author and of National Company. The equivalent frequencies in microns and angstrom units for wavelengths from 10 meters to 0.0000001-meter are given in optional figures of 10 to the respective exponent and in round numbers. Although the fog-piercing wavelengths immediately below 1 meter are shown as being particularly suitable for operation of the radio traffic lights it is pointed out that the operation of the radio traffic lights is not restricted to this microwave region.

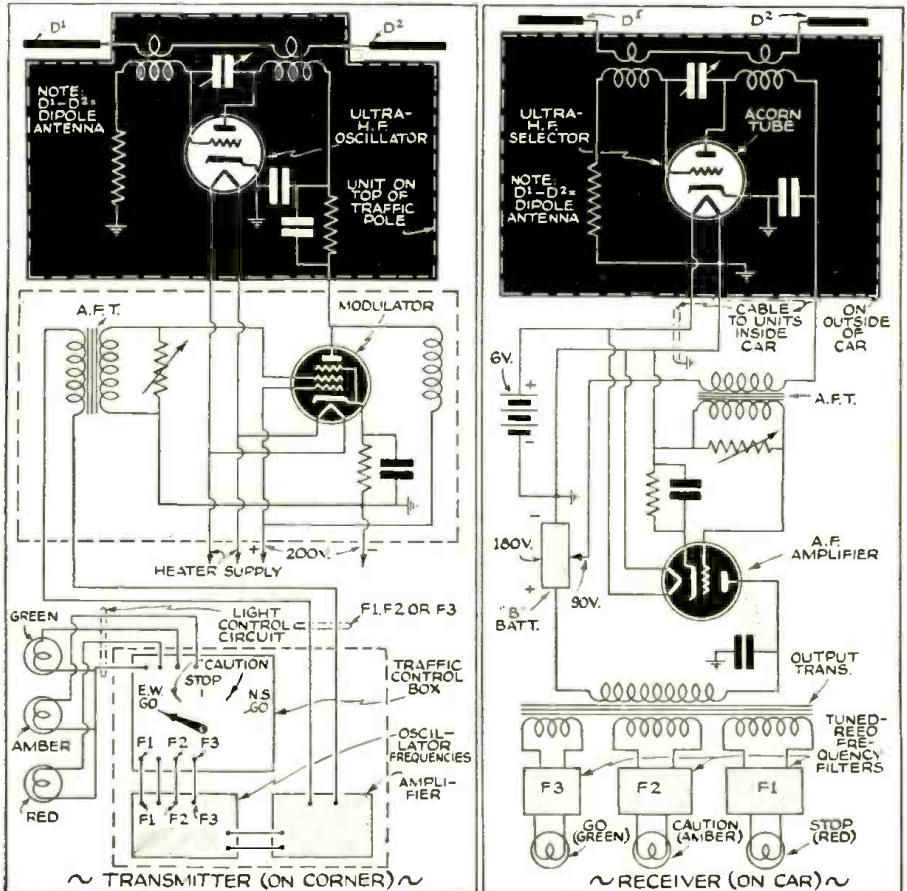

Above are illustrated experimental circuit variations as delineated in the original patent specifications and further modified to include wiring for the amber (caution) lamp, etc. One circuit represents the U.-H.F. transmitter unit which perches atop the traffic-signal stanchion. The other represents the receiving set-up (in principle) outside and within the car. All available information is given above.

CORRECTION NOTICE

The editors of *Radio-Craft* pulled a "boner" last month when they erroneously associated Mr. John F. Rider with "Superior Instruments, Inc.," whereas actually he has no connection whatever with that organization. The error occurred on page 265-266 in the article titled "Radio Servicing" which we reprint below in corrected form.

A further error, typographical this time, occurred twice on page 293 in the article "Signal Test System of Trouble Shooting" in that the word "Chanalyst" appeared as "Chanalyzer". There is no such instrument as a chanalyzer; "Chanalyst" is the correct word.—Sorry it happened.

RADIO SERVICING



JOHN F. RIDER

Publisher of Radio Service Books; President, Service Instruments, Inc., New York, N. Y.

THERE are numerous ways of cashing-in on radio education, but one thing is certain: it is extremely difficult to accomplish anything in the technical branch of the radio field unless a radio education is the background. The man with the proper technical education is the individual with the best opportunity.

Our association with the radio industry has been in connection with the service branch. We have witnessed various changes in this field and the conclusions drawn during the past 5 years are being daily confirmed. The Serviceman with the technical background will be the one to survive the present weeding process.

We have seen the service branch pass through prosperous days and days of depression, yet in every part of the nation could be found Servicemen—men who had sufficient confidence to acquire a technical education—who made money during both periods.

A technical education does more than just fortify the Serviceman with the ability to do a job. . . . It also gives him the confidence he so badly needs to charge for the work he does. Therein lies the basis of success. . . . Every publication now being published in the interests of the radio industry contains material which proves that radio receivers have passed out of the simple class into the category of complicated apparatus. What with television in the offing, there is no doubt about the fact that the men who work upon these instruments will require a technical background and further that the man with a radio education will have ample opportunity to cash-in on the money and time he spent acquiring the knowledge.

**Bakelite
V. C.
Form
1 1/2
Inches**

**Power
Handling
15 Watts**

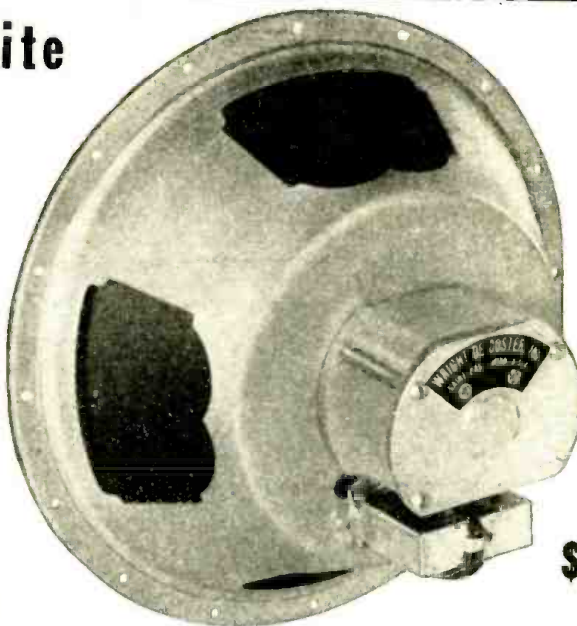

**Weight
of
Magnet
40
OZ.
List
Price
\$12.00**

**N12XL Special 12" Nokoil
Line Trans. 500, 1000, 1500 Ohms
Also N10XL-10" \$11.00 — N8XL-8" \$10.00**

Those Who Know Quality
Demand Wright-DeCoster
Write for New RED Catalog

WRIGHT - DE COSTER, Inc.

2251 University Ave.
ST. PAUL, MINN.

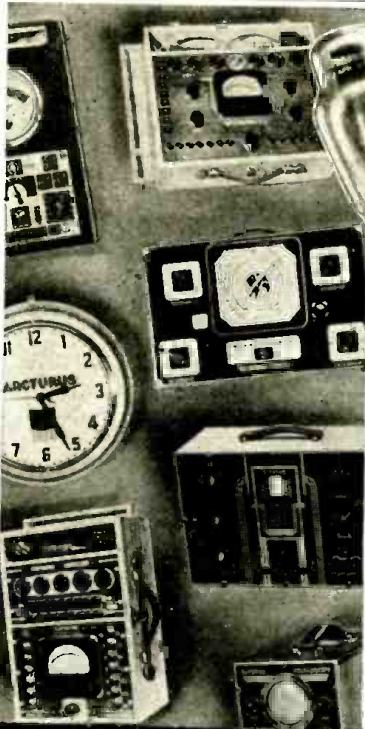

**LATEST MODELS
NOW INCLUDED!**

*... In the Arcturus
Equipment Deal*

Chances are you've been "casting a fond eye" over the handsome new jobs the famous makers of test equipment now offer. Perhaps you've even decided upon the units you want for your shop. Now you're asking yourself, "Can I afford it?"

You can! The easy ARCTURUS EQUIPMENT DEAL brings you the newest, most efficient store and ship equipment on the market . . . at almost NO COST!

You have your choice of a wide variety of high quality equipment, like that illustrated here . . . and your regular purchases of ARCTURUS TUBES pay for it!

MODERN EQUIPMENT almost FREE

Lower Tube Requirements—Lower Down Payments—Tubes at Standard Prices—Immediate Delivery of the units you select . . . these features make the ARCTURUS PLAN the easiest, fairest and most profitable Deal ever offered to dealers and servicemen.

Arcturus Tube quality assures you of customer satisfaction on every sale. New Arcturus Dealer Helps bring new customers into your store again and again. The Arcturus Equipment Deal gives you worthwhile EXTRA PROFITS in the form of valuable equipment! It's a combination hard to beat—take advantage of it!

Mail the coupon for full details—today!

"Go ARCTURUS" FOR Extra PROFITS

ARCTURUS RADIO TUBE CO., Newark, N. J. C-12
Without cost or obligation on my part, send details of your Equipment Deal and the new Dealer Helps Folder.

Name _____
Street _____
City _____ State _____
 I am a dealer I am a serviceman
My Jobber is _____
For convenience, paste coupon on penny postcard.

**MAIL
TODAY**

HANDY A. C. & D. C. VOLT- OHM-MILLIAMMETER



Pocket Size

MODEL 736
Only \$12.00

Sturdy, molded case with rounded corners; accessories included.

Readings: A.C. and D.C. Volts 0-15-150-750; D.C. at 1000 ohms per volt and A.C. at 400 ohms per volt; D.C. Milliamperes, 0-1 1/2-15-150; Low Ohms, 1/2 to 1000; High Ohms, 0-100,000 at 1 1/2 volts. External batteries may be used for higher resistance measurements. Jacks are arranged to facilitate ease of operation.

Model 737 for D.C. only\$9.30
Model 735—ranges same as for 737 but operation is simplified by handy selector switch\$10.80

READRITE METER WORKS
1216 College Ave., Bluffton, Ohio

Please send me more information on—
 Model 736 Model 737 Model 735

Name

Address

City State

6-VOLT UNIVERSAL POWER PACK

LISTS \$15.00
At Less Than Price 6-Prong Synchronous Vibrator Alone!

operates 2 volt set from 6 volt storage battery; also operates 6 volt house sets, auto sets, S.W. transmitters and receivers. Output, 180 Volts at 50 M.A. On 4 Volt cell supplies 120 Volts at 30 M.A. Housed in case 3"x4"x1 1/2". Shipping weight, 6 lbs.

Only \$3.29 NET

25% Deposit required with Order, Balance C. O. D.
ARROW SALES CO. 27 S. JEFFERSON ST. CHICAGO, ILL.

RADIO ENGINEERING

RCA Institutes offer an intensive course of high standard embracing all phases of Radio and Television. Practical training with modern equipment at New York and Chicago schools. Also specialized courses and Home Study Courses under "No obligation" plan. Catalog sent, RT-38.

RCA INSTITUTES, Inc.
A Radio Corporation of America Service
75 Varick St., New York 1154 Merchandise Mart, Chicago

Print Your Own

Carus, Stationery, Advertising, labels, paper, circulars, tags, etc. Save money and time. Sold direct from factory only. Junior outfit \$8.25, Senior outfits \$17 and up. Do popular raised printing like engraving with any of our presses. Print for Others, Big Profits Pays for itself in a short time. Easy rules sent. Write for free catalog of outfits and all details. Kelsey Presses N-97, Meriden, Conn.

EXCELSIOR

EVERYTHING IN RADIO!

A COMPLETE SOURCE FOR YOUR RADIO NEEDS
Our immense stock of radio sets, parts and supplies enables you to purchase your entire needs on one order. You will find all your Nationally Known Favorites in this big book which is FREE for the asking. Practically every order is shipped the same day it is received.

WHITE FOR BIG NEW CATALOG

BURSTEIN-APPLEBEE CO.
1012-14 McGee St. • Kansas City, Mo

RADIO TRADE DIGEST

DUN & BRADSTREET SURVEY RADIO BIZ

(Continued from page 353)

to report operations maintained at a somewhat higher rate than the average, but even in these lines production was down 10 to 25%.

Dealer response to initial showings of 1939 models led many producers to revise upward working schedules planned for the Summer and Fall. On the basis of the improved trend in inquiries and orders, the trade estimated that approximately 4,000,000 sets would be produced between July 1 and the year-end.

Though advertising revenue evidenced a downtrend from month to month, cumulative broadcast billings from January through July still showed a substantial gain over the 1937 period. Network sales for the seven months, compiled by Publishers' Information Bureau, totalled \$42,440,323, 4% more than in the previous year.

Retail Drop Narrowed

In the first six months of 1938, retail sales of radios ranged from 25 to 45% below the corresponding period of 1937. Introduction of new models in July helped to raise sales totals in most districts during July and August. Results for these months were generally the best so far this year. Some centers in the West and South reported volume substantially ahead of the 1937 comparative, but the average for the country as a whole remained 15 to 25% under a year ago, according to Dun & Bradstreet.

Price cuts and consumer emphasis on medium- and low-priced merchandise were responsible for sharp contraction in dollar volume in the first half of the year against the 1937 showing. Most dealers found unit sales up to (or no more than 10% below) the previous year. Demand centered on table models ranging in price from \$20 to \$35.

"FACSY" A FLOP?

(Continued from page 353)

Expressing their opinion of facsy's importance, the vote was:—

Great	33.4%
Doubtful	14.8
Minor	22.2
Unimportant	29.6
Thus, 76.6% do not believe that facsy will be much of a factor in the industry.	

In gauging the price at which facsy should be sold to the public, a wide divergence of opinion was found. There was a low peak at the \$25-50 price range and a higher one at \$150 and upward. The tabulation:—

Under \$25	3.5%
\$25-50 (inc.)	26.0
\$51-100 (inc.)	14.7
\$101-150 (inc.)	3.7
Over \$150	40.6
Unsuited to consumer sales, but good for commercial applications	11.5

The cost of the paper used in the reproducer was next considered. The opinions were about what might be expected, with the largest vote being for price to compete with newspapers. The following tabulation indicates this very clearly.

Less than newspaper or free	33.4%
About same as newspaper	55.6
Not over 25c daily	11.0
Out of fairness, however, it should be	

with low-priced combination radio and phonograph models next in popularity.

Refinements in remote control and automatic tuning were the chief sales attractions of the 1939 models. Time and energy savers in the form of program pre-selectors and remote control boxes were stressed in various lines. Further perfection of button-tuning models promised scientific accuracy in tuning.

Prices Lowered

Price reductions accompanied the improvements in styling and mechanization on the 1939 models. The average price of all models dropped to \$57.60 for 1938-1939, compared with \$67.50 in the season preceding, and \$65 two years ago, according to *Radio Today*. A separate compilation for consoles, showing an average price of \$100.50 against \$116 on 1938 lines, indicated that the larger volume of small table models was not alone responsible for the lower average price.

Stability in the price structure was counted upon through new fair trade contracts submitted to dealers by manufacturers. These established the maximum amount that might be deducted from the list price for trade-ins or any other reason. Following the price demoralization of the first part of the year, the new regulations were regarded by producers and dealers alike as a significant step forward.

More careful supervision of credits and an improvement in consumer income contributed to a quickening of retail collections during July and August. Repossessions fell off sharply. Manufacturers and wholesalers classed payments as fair to satisfactory, despite a continued sluggishness in some retail accounts.

noted that the responses to questions relative to facsimile were far fewer than those relating to television, radio and other more familiar subjects. Only about 1/3 of the questionnaires received answered the questions about facsimile.

(NEXT MONTH: Profitable sidelines for dealers and manufacturers, as revealed by the RTD Questionnaire, will be disclosed in this section. There may be a money-making idea for you. Don't miss it!)

SCANNING THE TELLY FIELD

(Continued from page 354)

to have license arrangements with RCA & Hazeltine.

RMA STANDARDS TO FCC

The RMA television committee has sent its proposed standards to the FCC, which is expected to approve them almost in their entirety.

Suggestions include 6 mc. band width for video; sound 4.5 mc. higher and at least 1/4 mc. below upper limit of band; all to become effective when ssb xmission is used. Width-height ratio to be 4:3; images, 30 per sec. at 441 lines.

PUBLIC'S QUERIES—& TRADE'S

Reuben Public is asking questions mentioned in 2d paragraph, but better informed trade still wonders where adequate program financing will come from. While mfrs. can afford to put out sets, Reuben can't afford to buy unless they're priced right—& can

RADIO TRADE DIGEST

it be done? There seems little use in erecting stations save in most densely populated areas. Meanwhile, vicious circle continues:—Masses won't buy sets unless assured of good, consistent programs; advertisers won't sponsor g., e. pros. unless assured of mass audience.

Or will they, in effort to gain publicity from pioneering?

WORD FROM ABROAD

According to *Motion Picture Herald*, Germany is way ahead of U. S. in television, one feature being a large-screen projection 15 times as bright as normal screen. Also shown is natural color television. (But Bell Labs., in U. S., demonstrated that 10 years ago.) RTD wonders whether U. S. is not far ahead of world in telly, but holding info back until market is ready.

In Britain, telly has been hurting receiver sales. Dealers there have gotten telly mfrs. to agree not to demonstrate sets outside of telly service area. This keeps prospects in non-serviced areas from withholding purchases in hope that video programs will be available soon.

MOVIES IN TELEVISION

Now 3 major film cos. have telly tie-ups. These are RKO-Radio Pictures with RCA Television. Warner Bros. with Trans-American Broadcasting & Television Corp., & Paramount Pictures with Allen B. Du Mont Labs., Inc.

Paramount now owns half of Du Mont & supplies finances for furtherance of Du Mont patents & developments—a logical way of getting adequate cash.

Du Mont equipment has been in the works for years. A set said to be capable of retailing at little over \$100 was demonstrated successfully in recent months.

FARNSWORTH DEMONSTRATES ON COAST

Farnsworth xmtr & receiver were successfully demonstrated in Los Angeles on "live" & film pick-ups. Pix were black & white, 9 x 12 in., 441 line, reported by *Broadcasting* as comparable to movies.

FCC OKAYS EQUIP'T FOR BCST STATIONS

(Continued from page 356)

xmtr; Doolittle & Falknor, Inc.; 1306 W. 74th St., Chicago, Ill., (6) AFC, ATC. xmtr; Gates American Corp., Quincy, Ill., (2) xmtr; Hygrade Sylvania Corp., Clifton, N. J., (8) xmtr; International Broadcasting Equip't Co., 312 W. 51st St., Chicago, Ill., (4) AFC. xmtr; Kluge Radio Co., 1041 N. Bonnie Brae, Los Angeles, Calif., (3) xmtr; Piezoelectric Labs., 612 Rockland Ave., New Dorp, N. Y., (4) ATC. ose., amp.; Precision Piezo Service, 427 Asia St., Baton Rouge, La., (1) ATC; Premier Crystal Labs., Inc., 53-63 Park Row, N. Y. C., AFC; RCA-Victor, Inc., Camden, N. J., (47) AFC, xmtr, exctr. amp., mod.; Radio Eng. Labs., Inc., 100 Wilbur Ave., L. I. City, N. Y., (2) AFC, xmtr; D. V. Tostenson, Moorhead, Minn., (5) AFC, ATC. xmtr; Western Electric Co., 195 Broadway, N. Y. C., (49) AFC, xmtr, amp.; Western Radio Eng. Co., Inc., 5th & St. Peter Sts., St. Paul, Minn., (1) AFC.

In the foregoing, AFC indicates Automatic Frequency Control Unit; ATC, Automatic Temperature Control Unit; amp., amplifier unit; mod., modulator unit; xmtr, transmitter; exctr, exciter unit.

New RCA 3" Oscillograph Brings You Many New Features at a Popular Price

This oscillograph, the newest addition to the No. 150 Series of RCA Test Equipment, includes many new features. All the controls, including the spot centering controls are on the front panel. Smaller size and lighter weight greatly increase the portability of this instrument. And its new styling and finer performance make it unusually attractive. You'll agree it's a bargain!



SPECIFICATIONS

Radiotrons 1 RCA 906 (improved type), 2-6C6, 2-80, 1-884—Total 6.
Sensitivity without amplifier—20 volts (RMS) per inch deflection. With amplifier—0.5 volt (RMS) per inch deflection.
Amplifier Response Flat, 20-90,000 cycles—Gain 40.
Timing Axis 15-22,000 cycles.
Controls Front panel for all operations, including centering.
Power Supply 110 volts, 50-60 cycles.
Input Power 50 watts.
Dimensions H 15", W 8", D 14".
Finish Blue-gray baked wrinkle lacquer—streamlined handle.

\$63.95 Net Stock No. 155

Over 325 million RCA radio tubes have been purchased by radio users . . . In tubes, as in parts and test equipment, it pays to go RCA All the Way.

RCA presents the Magic Key every Sunday, 2 to 3 P. M., E. S. T., on the NBC Blue Network.



Parts

FOR PROFIT

RCA Manufacturing Co., Inc., Camden, N. J.
A Service of Radio Corporation of America

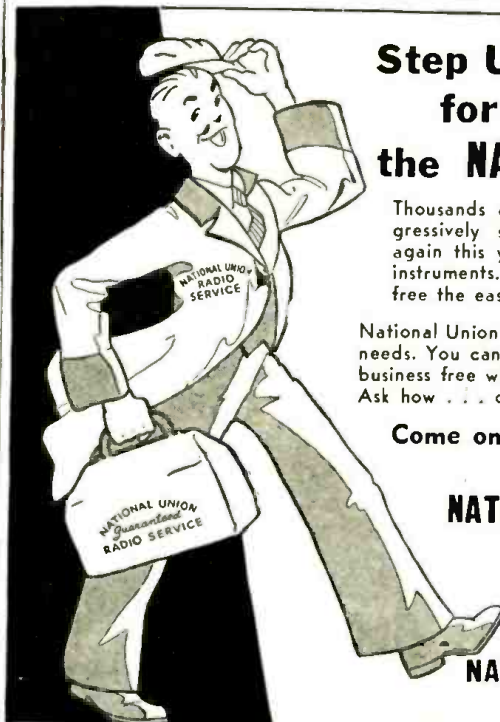

Step Up! Equip Yourself for More Business the NATIONAL UNION way

Thousands of Radio Service Engineers are aggressively stepping ahead for more business again this year, equipped to get it with latest instruments. They're getting these instruments free the easy N. U. way. Why don't you?

National Union provides equipment to fit every dealer's needs. You can have the things you need to get more business free with purchases of N. U. quality products. Ask how . . . do it now!

Come on! Build Customer Confidence

with
NATIONAL UNION QUALITY Tubes—Condensers

WRITE FOR DETAILS and NAME OF NEAREST DISTRIBUTOR

NATIONAL UNION RADIO CORP.
NEWARK, N. J.

PATENTS—TRADE MARKS

All cases submitted given personal attention by members of the firm.

Form "Evidence of Conception" with instructions for use and "Schedule of Government and Attorney Fees"—Free

LANCASTER, ALLWINE & ROMMEL

PATENT LAW OFFICES

436 Bowen Bldg. Washington, D. C.

GOOD MEN IN RADIO JOBS HAVE GOOD

You need something more than just "good intentions" to get ahead in Radio. Today's opportunities go to the men with **TECHNICAL TRAINING**. Our "Tested Plan" tells how YOU can improve your position. Write for your **FREE COPY** right now—**CAPITOL RADIO ENGINEERING INSTITUTE** Dept. RC-12 3224-16th St., N.W. Wash., D. C.

Westinghouse Power Generator

Manufactured for U. S. Signal Corps
200 Watt. 110 V. AC

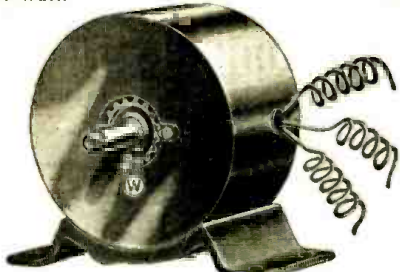

A. C. ELECTRICAL POWER

from a Windmill, from available Waterpower, from your Automobile, from your Motorcycle, from your Bicycle, Foot-pedals or Handcrank (for transportable Radio Transmitters, Strong Floodlights, Advertising Signs); do you want to operate AC Radio sets from 32 V. DC farm light systems; operate two generators in series to get 200 V. AC; obtain two phase and three phase AC, etc., etc.

There Are Over 25 Applications

Some of which are:

A.C. Dynamo lighting from eight to ten 20 Watt 110 Volt lamps. Short Wave Transmitter supplying 110 Volts AC for operating "Ham" transmitter. Operating 110 V. AC 60 Cycle Radio Receiver in DC districts. Motor Generator. Puhle Address Systems. Electric Sirens on motor boats, yachts, etc. Camp Lighting. Short Wave artificial lights, etc. Television. Pelton Waterwheel for lighting or other purposes. Airplane: for lighting strong search lights or electric signs. Laboratory work, etc., etc.

1/4 to 1/2 H.P. needed to run generator.
BLUE-PRINT 22 x 28 in. and Four-Page
8 1/2 x 12 in. INSTRUCTION SHEETS
FREE with Generator.

Generator, as described, including four replacement carbon brushes. Blue-print and instructions **\$7.90**

Send \$2.00 deposit balance C.O.D. Shipping weight 18 lbs.

(Replacement carbon brushes bought separate \$1.50 per set of four. Set of instructions bought separate \$1.00.)
MONEY-BACK GUARANTEE

WELLWORTH TRADING COMPANY
560 West Washington Blvd., Dept. RC-12-38, Chicago, Ill.

COMPLETE DYNAMIC TESTING

Direct, quick, practical instruction for complete 14-point check of all receivers with cathode ray, easily mastered by anyone who can read a circuit diagram. Without it, you're behind the times! Get your copy TODAY!

50c
FREE WITH ANY C-B INSTRUMENT
Clough-Brangle Co., Chicago, Ill. U.S.A.

WE HAVE THE RADIO YOU WANT

Our 1939 catalog is chock full of new Standard Brand Radios for Home-Farm-Auto. Over 400 models. Also hundreds of Electric Appliances for the home. Celebrating our 50th Anniversary with Big Bargains. Write for your copy today. It's FREE.

Correspondence Courses in RADIO and ELECTRICAL ENGINEERING

ELECTRICAL ENGINEERING Get good GRASP of wide electrical field. Prepare yourself, at Low Cost, for secure future. Modern, simplified, you can understand quickly.

RADIO ENGINEERING Extra fine course in radio. Public address, photo-electric work. Trains you to be super-service man, real vacuum tube technician. Expts. kits furnished. Diploma on completion. Tuition, \$25 either course. Deferred payment plan. Get copies of school catalogs, student magazines, complete details. SEND NOW!

LINCOLN ENGINEERING SCHOOL, Box 931-C12, LINCOLN, NEBR.

FREE TUBES!

one free for every 25 tubes ordered.

2A7	\$1.15	6B7	\$1.25	6A8G	\$1.30
55	.15	41	.25	6C5G	.30
71A	.20	1V	.25	6J5G	.30
6A7	.25	42	.25	57	.30

All guaranteed. Send this ad with your order.
NEW YORK RADIO SUPPLY CO.
152 West 42 St., N. Y. C.

WHEN YOU THINK OF AMPLIFIERS

REMEMBER TO SEND FOR OUR FREE 1938 P. M. CATALOG of Amplifiers. Designed by A. C. Sherry

AMPLIFIER CO. OF AMERICA
37-47 West 20th St., New York, N. Y.

RADIO TRADE DIGEST

\$'s & No.'s

(Continued from page 354)

on the first page of this section. The record of failures is not so shiny; there were as many bankruptcies in the first 7 months of '38 as in some complete previous years. Read on, and be enlightened.

Complete insolvency record for the radio industry from 1930 to July, 1938, inclusive, as compiled by DUN & BRADSTREET, INC., shows:

Year	Manufacturers Number	Liabilities
1930	40	\$3,522,400
1931	35	4,088,445
1932	39	2,039,000
1933	31	3,705,592
1934	12	1,244,000
1935	7	156,000
1936	6	274,000
1937	5	109,000
1938*	6	385,000

Year	Wholesalers and Retailers Number	Liabilities
1930	217	\$2,071,392
1931	160	4,979,359
1932	164	1,969,000
1933	109	1,813,980
1934	48	2,296,000
1935	48	450,000
1936	48	547,000
1937	46	517,000
1938*	39	271,000

(* January to July, inclusive.)

These statistics of failures in the radio industry are exclusive of applications under Section 77-B. From June 7, 1934, when Section 77-B of the New Bankruptcy Act became effective, to July 31, 1938 applications were filed by 13 manufacturers and by 5 wholesalers and retailers.

JAPANESE FANS:—In Nippon, listeners' licenses upped 122,836 to 3,741,291, an average of 259 sets per 1000 families.

SALES CLIMBING:—Although Aug. excise tax collections on radio were 47.5% below 8/37, they were above preceding mo.; were 2nd largest in '38.

JOBS INCREASE:—June radio factory employment was 6.9% above May, but 49.4% below 6/37. Payrolls, though up 7.2%, were 51.9% below 6/37. Average weekly wage was \$22.07; up .4% from May, but down 4.8% from 6/37. Hours, 36.9 weekly average, up 2% from May, down 3.6% from 6/37.

EXPORTS SLIDING:—38% below 1937, for July, The breakdown:—

	July, 1938	July, 1937
Sets	31,001	45,768
	\$675,285	\$1,171,681
Tubes	557,446	796,624
	\$233,366	\$339,193
Parts	\$510,488	\$788,542
Xmtrs	\$122,486	\$230,341
Speakers	42,097	53,640
	\$79,045	\$94,812
TOTAL VALUE	\$1,620,670	\$2,624,569

UP & DOWN:—NBC's gross billings were up 9.3% & MBS's up 64.7% for July as compared with preceding year. But CBS's were down 31.2%. However, all were up for 1st 7 mo.—NBC 5.9%, CBS 0.9%, MBS 19.1%.

RCA HIT:—No cause for rejoicing in the latest RCA report, with 2nd 1/4 of '38 hit-
(Continued on opposite page)

BOOK REVIEWS

NATIONAL UNION QUICK REFERENCE RADIO TUBE MANUAL. (1938) Published by National Union Radio Corp. Size, 5 x 8 ins., stiff paper cover. 169 pages, illustrated. Price \$1.00.

The newest in radio tube manuals has several features which will interest technicians. Tubes are grouped by function rather than by numerical or alphabetical sequence. This method of grouping greatly facilitates comparison of tubes of a single class without the necessity of searching throughout an entire volume.

At the beginning of each functional section is presented a generalized discussion pertaining to use of tubes in that particular section. Thus, application material for all tubes of a given class is available in one place.

Within the sections, they are listed in numerical-alphabetical sequence. In using the book, you will not encounter the situation of looking up one type only to find that you are referred to another tube.

And, in the section entitled "Design Considerations", are embodied a number of new ideas for the beginner, experimenter and advanced technician.

The book has been sturdily bound for hard usage and provides the convenience of spiral binding which permits the page to lay flat while being studied.

thoroughly", says the publisher, which about sums the story. It is unfortunate that the author permitted himself to fall into the rut followed by many writers of failing to supply the specific component values in the schematic circuits.

Part I of 156 pages covers development and physical properties; Part II of 123 pages covers technical uses of photoelements.

Chapter headings are given below; subdivisions of chapter VIII are included:

Part I: Historical Development of the Photoconductor Photoeffect; Physical Properties of Semiconductor Photocells. Part II: Construction and Performance of the Photoelements; Photoelectric Illumination Meters; Exposure Meters for Photographic Purposes; Special Photometric Apparatus; Long-Distance Transmission of Quantities; Amplifying Equipment; Photoelectric Switching and Signal Devices; Use in Various Fields of Activity—Chemistry, Physics, Astronomy, Bioclimatology and Meteorology, Oceanography and Hydrography, Medicine, Electrical Engineering, Photoelements as Sources of Energy.

ZERO TO EIGHTY. by E. F. Northrup (1937). Published by Scientific Publishing Company. Size, 6 x 9 ins., cloth cover, 29 illustrations. Price \$3.00.

"Zero to Eighty" is Book I of a set of scientific satires. It is the imaginative autobiography of a scientist living from 1920 to 2000 A.D. and telling the story of the first humans to encircle the moon. Radio experimenters will be intrigued with the technical details, including purportedly authentic illustrations of apparatus yet to be invented, as conceived by the eminent Dr. Northrup under the pseudonym of Dr. Pseudoman.

PHOTOELEMENTS AND THEIR APPLICATION. by Dr. Bruno Lange (1938); translated by Ansel St. John. Published by Reinhold Publishing Corp. Size, 6 x 9 ins., cloth covers, 167 illustrations, 297 pages. Price \$5.50.

"We feel that this is a particularly fine and timely book and perhaps the only text so far published in this country which covers this field

Please Say That You Saw It in RADIO-CRAFT

RADIO TRADE DIGEST

(Continued from opposite page)

ting slide worse than 1st 6 mo. The figs.:—1st 6 mo., Net profit, \$2,524,756.50 ('37 was \$4,647,385.64). Common stock earnings, \$0.066 ('37 was \$0.219); 2nd 1/4. Net profit, \$1,086,955.54 ('37 was \$2,404,328.84), Common stock earnings, \$0.02 ('37 was \$0.115).

NBC EXPECTING:—So far best since '26, NBC expects '38 to hit all-time high. 27 new sponsored shows have been booked; more are in work. July biz was just under 3 million—9.3% over preceding yr.; 1st 7 mos. averaged \$3,235,000—about 200 Gs over '37.

MAC TOPS LIST:—Semi-annual Hooper report, as quoted in *Radio Daily*, gives Charlie McCarthy leading NBC shows with 35.4% of interviewed homes listening; Benny 2nd, with 30.4%; Lux & Crosby shows neck-&-neck at about 25%. Ad value is shown as 96.4% know Ford sponsors Ford show & makes cars; 95.9% that Lux sponsors Lux & sells soap.

SNOOPS & SCOOPS

(Continued from page 355)

bought a plane to conduct ground-to-plane test, despite fact that major airline is also testing fancy equip't.

Aerovox's new Pyrohm Jr. wire-wound resistors have a fused vitreous enamel coating . . . FCC okayed WEVD's grab of WFAB's time, giving the "labor" station 36 more hrs. per wk. . . . Get a load of Stewart-Warner's new dope on handling claims for damaged products; it's vewwy, vewwy good . . . Ads stressing operating economy of farm Philcos will appear in some 2 doz. rural rags . . . **NuTone Chimes, Inc.**, of Cincy, just took an FTC licking on Tune-A-Tube & will drop "wild" claims.

R. W. Barrell of **G-E** has rigged up a p-e cell at his father's bed, to sound a gong when pop goes sleepwalking. Have you a somnambulist or icebox raider in your family? . . . **KSD** took out a fancy license. . . . **WFO** of Des Moines will have an FCC hearing on application for 1/2-million watter. & **Moody Bible Inst.** gets one for a new sta. . . . **Emerson** has embarked upon the biggest adv. campaign in its history, using color ads in natl. mags, broadsides, papers, etc. *But are they neglecting radio bests?*

Survey of 124 ordinary people in Philly showed 111 (that's 92%) satisfied with radio's progress; 3 had no sets . . . **G-E** announces a new fuse plug that can't be tampered with . . . And a 4-battery Tungar charger, too. . . . Congrats to **McMurdo Silver's Masterpiece**, which won the Grand Prix in the radio & television section of the 1937 Paris Int'nat'l Exposition; **Capehart** copped it in the phono section. **RCA** is running a course on merchandising, selling & advertising its records; 55 dealers & salesmen attended first session. . . . **Philco** broke all parts sales records in July, beating previous yr. by 25% . . . Help! Help! Does anybody know where to find the **American Radio Audience Co.**, formerly of 11 W. 42 St., N. Y. C.? They've vanished! . . . FCC has given tentative approval to various wireless remote controls, but may clamp down if there are complaints—or if a war makes their use as xmtrs likely.

G-E announces new police radio equip't, including 25-w. xmtr, 16-w. mobile xmtr, & 2 superhet. receivers, for use on 20 to 42 mc. band . . . **FCC** will now let you file single application or modification to cover fixed, mobile & portable equip't used in a single coordinated communication system . . . According to *Amer. Communications Assn's* publication, "**FCC Sabotages the 8-Hour Day**" . . . **J. F. Gilligan, Philco** exec., says the further south & west you go, the better biz is; slumps in Va. & N. C.; but he adds biz in latter jumped 225% in 2 mos. Some slump, hey, keed? . . . "**Thermion**," British "expert" implies that "press-button tuning" is not a sales success. Tsks! . . .

That rumor about the **Loew (MGM)** movie theaters being ready to blossom out with 3-dimension sound & sight (Polaroid?) is becoming pretty general . . . **Radio City Products** has a tiny 40c flashlight to clip onto a test prod . . . **Ampro Corp.** of Chi. has brought out a new 16 mm. arc projector—and has dropped prices way down to there . . . Why are so many cities letting their CP applications for police xmtrs lapse? . . .

Ken-Rad played host to 28 members of the Radio Guild of Ind. . . . **RCA-Victor** district sales mgrs. from all over U. S. attended a 3-day promotion fest in Camden . . . **FTC**, at it again, issues complaint against **International Radio Corp.**, Ann Arbor, Mich., **Wieboldt Stoves, Inc.**, Chi., & **Davega-City Radio, Inc.**, charging that they're advertising ballast tubes as "actively functioning" tubes. It's the first kick we've seen charging that cos. have "acted together & cooperated with each other in . . . false advertising practices" . . . More than 500 **Sparks-Withington** employees now have hospitalization included in their \$700,000 worth of accident & health group policies.

Solar Minicap dry electrolytics are now being made in the dual type . . . **Alfred Killian** of Chi., copped the 1st prize (completely equipped test bench) in the **Weston Francis Troiani**, Jamaica, N. Y.; third, 50th Anniversary Contest; Runner-up was **Harl O. Piety**, Lampasas, Tex.

It's an old story by now, but you'll have Television in the Spring.

PERSONALS

(Continued from page 356)

McComb Supply Co., Harlan, Ky. (E. Central); **Jones Philco Co.**, Saginaw, Mich. (Central); **Lofgren's**, Moline, Ill. (N. W.); **Southwest Radio Equip't Co.**, Okla. City, Okla. (S. W.); **Pensacola Hardware Co.**, Pensacola, Fla. (Charlotte); **Listenwalter & Gough**, Long Beach, Calif. (Pacific Coast).

CLARENCE OLMSTEAD is again talent buyer for Young & Rubicam adv. agy. in N. Y. **THURSE LEWIS** is his assistant. **JOSEPH R. STAUFFER** is Hollywood talent buyer for the agy.

J. E. BROWN, Chicago, **E. W. ENGSTROM**, Camden, & **I. J. KAAR**, Bridgeport, were made chairmen of the RMA committees on Television interference, xmtrs & receivers, respectively.

PAUL S. ELLISON is new chairman of RMA's N. Y. Sales Managers Club; **Ed S. RIEDEL**, of the Chicago Club.

(Continued on following page)

P.A. means PROFIT AHEAD!

Here's a typical example of Lafayette P.A. value—one of a complete line of advanced sound systems for 1939. Portable Model 810-T (choice of microphone) has many de luxe model features, including two 10" concert type speakers. **Lafayette is the world-popular P.A. line that means more profit for you.** And this year, Lafayette has everything—brilliant performance, streamlined compactness, extraordinary price-appeal. And a unit for every P.A. requirement. Send for List Price catalog especially prepared for servicemen.

LAFAYETTE
15 to 18 WATTS

THE MOST COMPLETE LINE IN THE WORLD

COMPLETE READY TO OPERATE
\$50.95

DUAL SPEAKER MODEL SYSTEM 810T



FREE LIST PRICE CATALOG FOR SERVICE MEN

Here's the book that describes in full detail the most complete line of sound systems in the world—at LIST PRICES. Complete listings of all parts needed to complete any installation no matter how small. Use it to show to your customers. It will help you sell them. Write for your FREE copy today.

WHOLESALE RADIO SERVICE CO. INC.
NEW YORK, N. Y. • CHICAGO, ILL. • ATLANTA, GA.
100 SIXTH AVENUE, NEW YORK, N. Y.

WHOLESALE RADIO SERVICE CO., INC.
100 SIXTH AVENUE, NEW YORK, N. Y.
Rush FREE List Price P.A. Catalog No. 74-3M8

Name.....

Address.....

City..... State.....

PASTE COUPON ON PENNY POST CARD

FREE TRIAL OFFER

NEW REMINGTON NOISELESS PORTABLE!
AS LITTLE AS



10¢ A DAY

Famous Remington Noiseless Portable that speaks in a whisper. Pay as little as 10¢ a day. Guaranteed by the factory. Standard keyboard. Automatic ribbon reverse. Variable line spacer and all the conveniences of the finest portable ever built. PLUS the NOISELESS feature. Act now. Send coupon TODAY for details.

You don't RISK a Penny

We send you Remington Noiseless Portable for 10 days' free trial. If not satisfied, send it back. We pay all shipping charges.

Typing Course and Carrying Case

You will receive FREE a complete simplified home course in Touch Typing, a handsome sturdy carrying case is included. No obligation. Mail coupon for full details—NOW.

Remington Rand, Inc., Dept. 189-12,
465 Washington St., Buffalo, N.Y.

Tell me, without obligation, how to get a Free Trial of a new Remington Noiseless Portable, including Carrying Case and Free Typing Course for as little as 10¢ a day. Send Catalogue.

Name
Address
City State

CHRISTMAS SEALS



Help to Protect Your Home from Tuberculosis

PHONOGRAPH RECORDS

12-OCCA, BLUEBIRD or VOCALION records-\$1.00
8-VICTOR, COLUMBIA or BRUNSWICK records-\$1.00
Each record is the standard 10" and plays both sides. Hot dance numbers, vocal instrumental, waltzes, old timers, cowboy, hill billy, etc. All popular artists. Hurry while they last. No C.O.D.'s. Send for our new, 1939 Fall Money-Saving Radio Catalog!

UNITED RADIO COMPANY
Dept. R-1000, Newark, N. J.

WE WANT USED TEST EQUIPMENT and METERS!

Have large order for European Shipment. Need used Radio Test Equipment and Meters. Will allow trade-in toward purchase of any instrument in our new Teeco line. Write immediately indicating make of instrument or meter. (Must be in working condition—appearance or age unimportant.)

TEST EQUIPMENT CO. OF AMERICA
139 Cedar St., Dept. XT, New York, N. Y.

RADIO TRADE DIGEST

PERSONALS

(Continued from preceding page)

Chairman S. T. THOMPSON of the RMA Export Committee has appointed DEMPSTER MCINTOSH, W. A. COOGAN, MAX ABRAMS & A. PROSDOCIMI (of N. Y.), J. E. BURKE & C. H. GREENE (of Chi.), H. A. MCCLUMPHE (Jackson, Mich.) & J. A. STREIBERT (Schenectady, N. Y.) to his committee.

EDWARD F. MCGRADY, V-P of RCA, has been elected to the board of directors of the NBC, filling the vacancy left by the death of JAMES R. SHEFFIELD.

EDWIN H. (Regeneration & Supers.) ARMSTRONG has applied for a license for his new hi-freq. relay station north of Alpine, N. J.

CHARLIE (C.W.) HORN, NBC director of research & development, spent a month in Europe this summer, visiting stas. in England, France, Italy, etc.

PHIL J. HENNESSEY, JR., NBC staff att'y in Washington, quit to take up private radio-legal practice. JOHN HURLEY, WRC-WMAL announcer, has been transferred to the legal staff; he's a Georgetown U. legal graduate, & passed his bar exams last year.

V. RUNYON, B. GINRICH, C. C. DE BORD, G. W. KISTLER, T. MANLEY, J. C. GRUNDY, C. C. JACKSON, R. CRATTY, T. F. MORRISON, C. G. GRIMM, E. W. THURN, & E. P. JONES all won air trips to the Bendix plant for being the 1st in their divisions to sell 10 home laundries.

W. E. MACFARLANE, chairman of board, A. J. MCCOSKER, pres., T. C. STREIBERT, 1st v-p, & E. M. ANTRIM, sec'y & treas., were reelected officers of MBS. Additional directors reelected were J. I. STRAUS, E. W. WOOD & F. WEBER. Net's commercial show take for 1st ½ of '38 was 19% over '37.

C. I. ROBBINS, foreign sales rep. for Arc-turus Radio Tube Co., is expected back from Europe some time in Dec.

Nominees for the IRE presidency, to be voted in Nov., are C. B. JOLLIFFE, of Camden, N. J., former C.E. of the FCC, & A. A. HEISING, N.Y.C. research eng. Nominees for directorships are VIRGIL M. GRAHAM, Emporium, Penna., chairman of RMA Standards Committee, & A. F. MURRAY, Phila., v-chairman of RMA Television Eng. Committee.

All the following is from the RADIO SERVICEMEN OF AMERICA. Ed Donnelly, treas. of the Binghamton Chapter married; members gave him & the Mrs. a silver coffee urn. J. Cummins addressed the Buffalo Chapter on Hi-Fi Set Alignment; Fred Lyson won the raffle. A Mr. LaPenna, of Staten Island, got lost in the wilds of Jersey when seeking the outing of the Newark Chapter; 50 men attended the shindig. The Pittsburgh Chapter mourns the death of Mrs. William Irlam, wife of its Secretary; J. Guzik is Chairman of this new chapter. A. F. L. de Quant, Sec'y of the Netherlands R. A., heads the chapter in Holland. A. C. W. Saunders, Director of District 20, is preparing a quiz for use by all Chapters. Walter Jones, of Hygrade Sylvania, addressed the Detroit Chapter. Watermelon brings the boys to the meetings of the Houston Chapter. John F. Rider addressed the Westchester Chapter, & will appear before others to demonstrate his analyzer.

WITTIQUIZ NOTICE

Sorry we have to omit the Wittiquiz Dec't this month again—we're deluged with important articles and news material which must take preference. Perhaps next month.

Please Say That You Saw It in RADIO-CRAFT

Attractive
MODERN DESK LAMP
Absolutely FREE
READ THE DETAILS

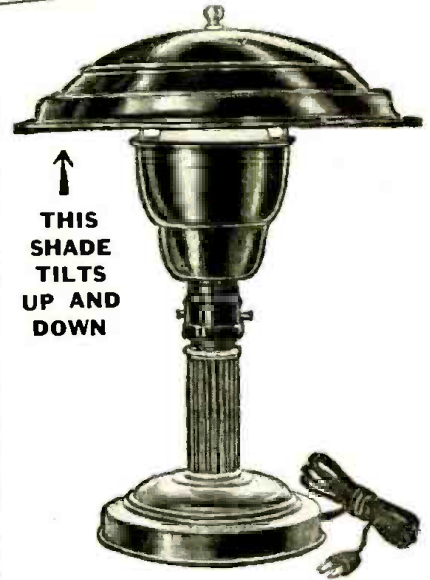

↑
THIS SHADE TILTS UP AND DOWN

JUST THINK OF IT—you can get absolutely FREE, the beautiful desk lamp shown at the left. This attractive desk lamp is suitable for home, desk, den, office, laboratory, studio or workshop. It is sent to you by the publishers with their compliments for a one-year subscription to RADIO-CRAFT. Look at the many fine features which this handsome desk lamp has. Read the list below.

HERE ARE THE LAMP FEATURES!

- ⊕ Constructed of metal with attractive bronze finish.
- ⊕ Scientifically constructed to give glareless, diffused light.
- ⊕ Helmet-type shade can be tilted to any convenient angle.
- ⊕ Stands 13" high and has 10" metal shade.
- ⊕ 5-foot rubber insulated cord and plug.
- ⊕ Constructed to last for many years.

Clip Coupon Today—and Mail!

Send your subscription today to RADIO-CRAFT for One Year (12 issues) and receive absolutely FREE one of these truly remarkable desk lamps. New subscribers are accepted or you may extend your present subscription another twelve months under this offer. Mail your remittance of \$2.50 (Plus 25¢ for shipping charges on lamp) to the publishers of RADIO-CRAFT. (Canada and foreign \$3.25) You will promptly receive your FREE DESK LAMP by return mail. Use the coupon below to order your subscription.

RADIO-CRAFT

99 Hudson Street NEW YORK, N. Y.

RADIO-CRAFT
99 HUDSON STREET, NEW YORK, N. Y.

Gentlemen: Enclosed you will find my remittance of \$2.50 for which enter my subscription to RADIO-CRAFT for One Year (12 issues). Send me promptly my FREE DESK LAMP. (Canada and foreign \$3.25.) In U. S. add 25¢ additional to cover shipping charges on lamp.

- () NEW SUBSCRIBER
() EXTEND PRESENT SUBSCRIPTION

Name

Address

City State

(Send remittance by check, money order or un-stamped U. S. postage stamps. Register letter if you send cash or stamps.)

RC.1238

RADIO TRADE DIGEST

NEW PUBLICATIONS

(Continued from page 356)

Cleveland, O. Technical data on mfr's. vibrators. Illus. with graphs, circuits & pictures.

AEROVOX CONDENSED CAT. Aerovox Corp., 70 Washington St., Brooklyn, N. Y. Lists all standard condensers of mfr's. line, plus most popular carbon & wire-wound resistors. Devotes 2 pp. to exact-duplicate motor-starting capacitors; 3 pp. to exact-duplicate replacement condensers. Free from mfr. or local jobbers.

RELAY BULLETIN 500. Kurman Electric Co., Inc., 241 Lafayette St., N. Y. C. Describes new medium duty, low price relay.

SONOCHORDE SPEAKERS. 4 pp. Sono-chorde Sales Co., 200 Boston Ave., Medford, Mass. Technical descriptions, diagrams & specifications of new model 5- & 6-in. speakers.

QUALITY TEST EQUIPMENT. Folder. Philco Radio & Television Corp., Phila., Penna. Data & net prices on 6 test instruments, portable amplifier, speaker & bench. (Note to Philco:—You really ought to print your name & address on your circulars.)

THERMO-GRIPS. Folder. Ideal Commu-tator Dresser Co., 1231 Park Ave., Sycamore, O. Descriptions of "electric pliers" which hold & heat work to be soldered. Two other folders describe engraving tools & power transmissions.

RADIO BROADCASTING STATIONS. Sept. 15, 1938. Folder. National Broadcast-ing Co., Radio City, N. Y. C. Map of U. S. & Canada, showing NBC networks in U. S. & Canada; lists of all stations in U. S. & Canada; freq. allocations; etc.



THE RIDER CHANALYST. 16 pp. Service Instruments, Inc., 404 Fourth Ave., N. Y. C. Two-color booklet giving features of the Rider Chanalyst, explaining the theory behind it, telling what it will do, listing several dozen applications, and explaining the instrument's operation and advantages. Copy upon request.

BOOK REVIEWS

THE 1938 RADIO ANNUAL. compiled by the staff of *Radio Daily*. Jack Alicante, Editor. Published by Radio Daily Corp. Size 6 x 9 ins., deluxe cloth covers, 960 pages. Free with a 1-year subscription to *Radio Daily*.

Here's a working manual for anyone, from the student career-man in broadcasting to the professional, interested in any phase of broadcasting. To say that the editorial index is 20 columns long will give some idea of the monumental scope of "The 1938 Edition of Radio Annual." Analyses by experts on detailed phases of the field afford a valuable cross-section breakdown of the topical subject. Of special value to broad-casting interests is a 19-page buying guide. Many other valuable listings included.

1938 "RADIO" HANDBOOK. by Frank C. Jones and the Technical Staff of "Radio". Published by

K. D. SMALL ELECTRIC MOTORS. 13 pp. Kendrick & Davis Co., Lebanon, N. H. Specifications & prices of several small motors, plus a watch demagnetizer.

DUNCO RELAYS. 32 pp. Struthers Dunn, Inc., 139 N. Juniper St., Phila., Pa. Specifi-cations on numerous relays, thermostats, counters, etc.

BULLETINS J-11 & J-13. Clarostat Mfg. Co., 285-7 N. 6th St., Brooklyn, N. Y. Data on p-a controls, including faders, gain, T-, L-, & Delta-T pads, attenuators, etc.

PERIODICALS

SOUND APPARATUS BULLETIN. Vol. IV, No. 2. 2 pp. Sound Apparatus Co., 150 W. 46th St., N. Y. C. Describes new record cutting mechanism.

A. R. T. BULLETIN. Vol. III, No. 2. 8 pp. Associated Radio Technicians of B. C., 918 Rogers Bldg., Vancouver, B. C. Organization notes, etc.

SYLVANIA NEWS. Vol. VII, No. 11. 4 pp. Hygrade Sylvania Corp., Emporium, Penna. News & data.

WHAT'S NEW. Aug.-Sept. 8 pp. Western Adv. Agency, 35 E. Wacker Dr., Chicago, Ill. Promotion for Jensen speakers, Vari-volt transformers, Triplett instrument (announces contest), Web-ster sound equip't, National Union tubes, etc.

BROADCAST MERCHANDISING. Vol. 6, No. 5, 6 pp. National Broadcasting Co., Radio City, N. Y. C. Promotion for best advtg.

COLD FACTS. Sept. 4 pp. Calif. Refrigerator Co., 1077 Mission St., Los Angeles, Calif. Gives data on refriger. sales & marvelous disclosure on "fur-bearing fish." (Pat. Pend.)

THE RADIO SERVICEMAN. Vol. 1, No. 7. 4 pp. Radio Servicemen of Amer., Inc., 304 S. Dearborn St., Chicago, Ill. Organization news, plus RCA-Victor shop notes sheet on Model 87K1.

RADIOGRAM. Vol. III, No. 12. 4 pp. Scott Wholesale Radio Co., 344 E. 4th St., Long Beach, Calif. Data on new apparatus handled. Monthly. sent on request.

JOURNAL. Vol. XV, No. 9. 32 pp. American Electronic Research Assn., 529 State Life Bldg., Indianapolis, Ind. Data on physiological applica-tions of electricity.

CATALOG. Scientific Diathermy Corp., 200 W. 34th St., N. Y. C. Describes new machine & boosts its use for home treatment. Sent free on request to mfr.

CATALOG No. 9. Atlas Resistor Co., 423 Broome St., N. Y. C., gives detailed information on mfr's line, from 5 to 200 watts. Sent free on request to mfr.

Radio, Ltd. Size, 6 x 9 ins., stiff paper covers, 512 pages, profusely illustrated. Price \$1.50.

The theory, design and construction of amateur radio equipment are discussed in great detail and with technical accuracy in this newest edition of a topnotch handbook. Contains hundreds of diagrams and photographs.

Chapter contents: Fundamental Electrical Principles and Radio Theory; Vacuum Tube Theory and Practice; Decibels and Logarithms; Learning the Code; Antennas, Feed Systems, and Coupling Methods; Radio Receiver Theory; Radio Receiver Construction; Receiving Tubes; Transmitting Tubes; Transmitter Theory; Exciter Construction; C.W. Transmitter Construction; Radio-telephony Theory; Radiotelephony Construction; U.-H.F. Communication and Equipment; Power Supplies; Test Equipment; Radio Therapy; Radio Laws and Regulations; Appendix.

Please Say That You Saw It in RADIO-CRAFT

Up to the minute
with new added
features at no
added cost.



MASTER TUBE TESTER

★ Tests all Receiving Tubes and has Ballast Tube Continuity Test.
★ Separate Plate Tests on Diodes and Rectifiers.

★ Uses Approved Emission Circuit Constructed to RMA Load Requirements.
★ Neon Short Test.

The Triplett Tube Tester in the Master Case has always been one of the most popular tube testers ever placed on the market. Now comes Model 1212 with new added features bringing this famous tester right up to the minute but at

NO ADDED COST!

This model is installed in a metal case 7" x 6" x 4" — the last word in compact size and lightness for a high grade, thoroughly professional, thoroughly dependable tube tester. Ideal for field work. Tester has three-color GOOD-BAD scale, line voltage adjustment and is set by selector switches from tube charts. Up-to-date charts are provided to all registered owners as new tubes appear. Dealer Net Price \$22.00

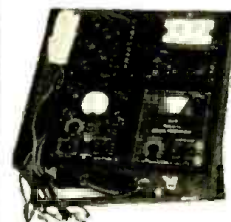

Be sure to enter Triplett's \$500.00 Radio Service Puzzle Contest... Get entry blank from your local Jobber.

TRIPLET MASTER TESTERS

A series of co-related single unit testers; made in standard case size; the most economical method yet devised for completely equipping the all-around service shop with high quality instruments. Start your master test set with this popular tube tester.

THE TRIPLET ELECTRICAL INSTRUMENT CO.
1612 Harmon Dr., Bluffton, Ohio

Please send me more information on—
 Model 1212 Radio Service Puzzle Contest

Name

Address

City State

DO IT NOW!

DUES WILL BE INCREASED JANUARY 1, 1939
\$1.00 of 1938 dues will be credited on
1939 dues if you join before
January 1, 1939.

MAIL THIS COUPON

RADIO SERVICEMEN OF AMERICA, INC.
304 South Dearborn St., Chicago, Ill.

Gentlemen:
I hereby make application for membership in the Radio Servicemen of America.

Name _____

Home Address _____

State _____

City _____

Firm Name _____

_____ I am enclosing \$2.00 National Yearly Dues. (Plus Nominal Local Chapter Dues).
_____ Bill me \$2.00 National Yearly Dues.

RC-12

The best
\$2.00
you ever
invested

10 x 12 FOOT, 441-LINE SCAN-DISC TELEVISION!

(Continued from page 341)

is so valuable it looks as though Hollywood has something here—if it isn't too proud to play second fiddle.

Another idea for Hollywood's more wide-awake moving spirits is a "lens screen"; even the problem of a balcony audience probably will not work any great hardship on technicians in applying the scheme. Briefly, it's a glorified version of the use of spangles on milady's dress. Except that instead of innumerable concave, polished metal washers, 2,000,000 mirrored lenses are used to project forward and downward, in a widespread beam, the light that would ordinarily be wasted by absorption, and by reflection toward the ceiling, and so on. An improvement in illumination of 30 times is thus obtained: in television use this means that images as bright or brighter than ordinary theatre movies are easy to obtain. *Radio-Craft* has visualized this "lens screen" in use in one view; an unretouched photo of a motion picture scene as it appeared when projected onto the 10 x 12 ft. screen by a high-intensity cathode-ray television tube in an intermediate-film machine is shown at A. (The photo was taken with an f. 3.5 aperture and 1/10-sec. exposure.)

The stunt of utilizing 4 points on the periphery of the Nipkow disc for 4-way scanning (views D and E) sounds to us a bit on the Scotch side; anyway, it's more for your money. The disc itself spins in a vacuum—which makes it possible to get up to 10,000 r.p.m. for 441-line fidelity (25 frames, interlaced).

Servicemen must keep
abreast of the times. Membership in

RSA helps servicemen to be better business men.

It provides advance technical information, it lets you know what other servicemen are doing, it provides an organization composed only of qualified servicemen, its membership reaches every state in the union, it has the sponsorship and backing of the entire industry. We want you as a member if you are a good serviceman.

RADIO SERVICEMEN of AMERICA, Inc.

Joe Marty, Jr., Executive Sec'y, 304 S. Dearborn St., Chicago

SEEKING RICHES FROM THE EARTH BY RADIO

STEADILY the technique is developing for the location of precious ore bodies and other mineral deposits in the earth by using radio. A very comprehensive article has been prepared, revealing circuits and methods, all based on verified experiments, giving full insight into this fascinating and promising field. By using methods now fully disclosed, gold coins, buried by prearrangement, were recovered, to the consternation of amazed onlookers.

All the world over, the eager search for the riches reposing in the recesses of the earth goes on. Success attends those efforts that scientifically determine the non-homogeneous character of the earth. Interpretation of these findings determines the straight path to precious deposits.

Acquaint yourself with the full facts about the earth as a treasure chest, and the exploration by radio devices by those seeking riches. Be among those fully conversant with the requirements for successful apparatus. Join in the treasure-seeking yourself. The full details are revealed in the article that treats of this historic development of methods of wresting the secrets from the earth, from the first divining rod to the latest high-powered heat oscillator. Remit with order.

25¢
POSTPAID

RELIABLE RADIO COMPANY
143 West 45th Street, New York, N. Y.

MAKING A SERVICEMAN'S TEST UNIT THE "SUPER-GENO-SCOPE"

(Continued from page 343)

units is J4, and the filament and ground returns are made through the common ground and the shield of the conducting leads.

The positive potential for the plate circuit of the external amplifier stage is obtained from the unit under test.

The balanced rectifier is designed to replace suspected defective modulators also for a low-voltage input and a low-current output rectifier. Also the rectified output voltage can be connected directly to a push-pull circuit without a push-pull coupling device (push-pull trans.) or a phase inverter circuit.

Let us observe the various controls on the front panel of the oscilloscope section (Fig. A) from left to right and top to bottom in the following order.

(1) The Vertical Control (R15) is the vertical beam centering adjustment. This permits the placement of the spot or image anywhere along the vertical line or axis (up or down) by varying the electrostatic field between D3, D4.

(2) Focus Control (R26) is the sharpness adjustment of the spot or image upon the screen. Focusing of the fluorescent spot produced by the beam is controlled by adjustment of the ratio of anode No. 2 voltage to anode No. 1 voltage. Ordinarily, the ratio is varied by adjustment of anode No. 1 voltage.

(3) Intensity Control (R28) is the brilliancy control of the spot or image. The control electrode (grid) of the cathode-ray tube is the controlling element which governs the speed of electrons. Varying the grid bias will in turn vary the current of

anode No. 2 which in relation to the bias will increase or decrease the spot or image intensity.

The Focus and Intensity controls are adjusted so that the spot or image viewed is sharp and brilliant enough to be examined with ease. Nothing is gained when the intensity is at its peak. As a matter of fact a stationary image or spot of excessive brilliancy is apt to damage the screen of the cathode-ray tube permanently.

(4) The Horizontal Spot Control (R16) is the same as the vertical spot control only it differs in that the displacement of the spot or image is along the horizontal axis (left to right). The electrostatic field is varied between D3, D4.

(5) The Synchronizing Selector (Sw.3) is the selector switch which permits the selection of the type of synchronizing voltage or pulse, or the interlocking timing to the time axis oscillator. The synchronizing voltage sources are internal, 60-cycle, and external.

(6 & 8) The Cut-in Switcher (Sw.1, Sw.2) will cut in or out either the vertical or the horizontal amplifiers or both, from the input circuits to D3, D1.

(7) Return-trace Eliminator (Sw.5, Sw.6) provides the return-trace elimination of the sweep circuit time axis oscillator or the 60-cycle sweep. Switch Sw.5-6 is a D.P.D.T. unit with a neutral position. Each pole is connected for single-throw operation. Pole 1 and contact 1 form the Sw.5 circuit; and pole 2 and contact 4 is the Sw.6 circuit. The neutral position is employed when the trace eliminator is not used.

(9) The Sweep Circuit Selector or the

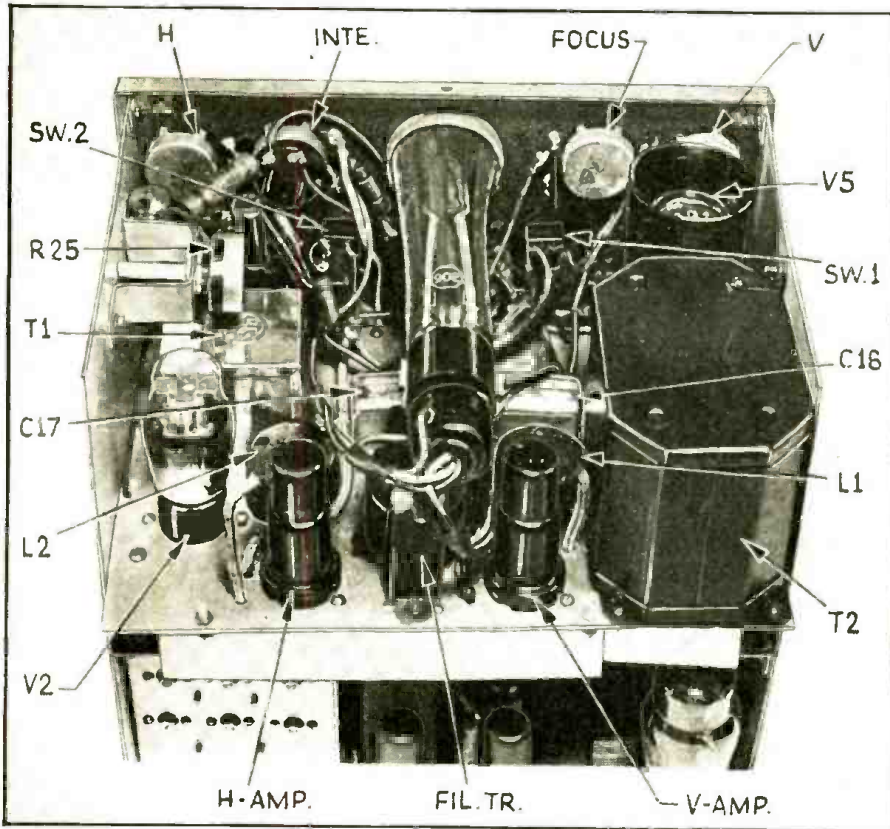

Fig. 8. Rear view, showing nearly all the components of the Scope section of this new test unit.

horizontal time axis input selector (Sw.8), provides the selection of the internal time axis oscillator, sixty cycle or external.

(10) The Vertical Gain Control (R1) controls the amplitude signal input or the height of the plotted image.

(11) The Synchronizing or Locking Control R10 affords quantitative control of the synchronizing voltage to lock the image.

(12 & 13) These units are the Fine and Coarse Frequency Controls of the time axis oscillator, respectively. Unit 12 (R14) is the variable resistor which varies the frequency between any two points of 13 (Sw.4). Item 13, or Sw.4, is an 8-point, 2-gang selector switch which, with the associated condensers, permits a frequency band at any one point.

(14) The Horizontal Gain Control (R7) controls the amplitude of the horizontal time axis voltage (or rather the width of the image or spot).

(15) The Time Axis Oscillator Stabilizer, R25, is mounted inside the case and once adjusted is seldom re-adjusted unless necessary due to circuit or tube changes. This control permits the establishment of the lowest frequency and a striking point to obtain or facilitate the formation of the sawtooth wave.

Tube terminal voltages are given in Table I.

TABLE I—TERMINAL VOLTAGES

Scope—

V1—plate 200 volts, screen-grid 65 volts, cathode 1.5 volts.

V4—plate 200 volts, screen-grid 65 volts, cathode 1.5 volts.

V2—plate, before load R, 325 volts, cathode 8 volts.

V3—anode No. 2 500 volts, anode No. 1 150 max. volts, cathode -45 volts.

V5—plates 450 volts.

Part II will discuss the various signal generators comprising the Super-Geno, followed by Part III (final installment) discussing general operation, applications and calibration of the various units.

LIST OF PARTS

("SCOPE" ONLY)

- CONDENSERS
- Three Solar mica condensers, 50 mmf., C, C36, C37;
- One Sprague condenser, 0.25-mf., 600 V., C1;
- Five Sprague condensers, 0.1-mf., 600 V., C2, C10, C14, C16, C17;
- One Sprague condenser, 0.03-mf., 600 V., C3;
- One Sprague condenser, 0.007-mf., 600 V., C4;

(Continued on following page)

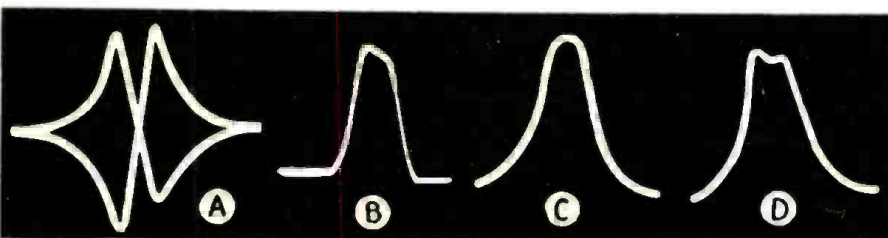
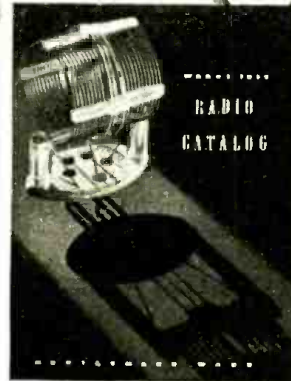

Fig. 2. A.F.C. (A) and I.F. curves (B, C, D) for G.E. and RCA receivers.

HOT OFF THE PRESS!

The Finest
RADIO CATALOG EVER PUBLISHED!

EVERYTHING SOLD ON TIME PAYMENTS



NATIONALLY ADVERTISED STANDARD MERCHANDISE
Amateur Transmitters, Receivers and Parts
Servicemen's Test Instruments and Equipment
Sound Systems of all Types
Inter-Office Communications Systems
AT LOWEST PRICES!

You can't afford to be without this finest of all radio catalogs! Whether it's sound equipment, test instruments or a new "rig" you need, you can make substantial savings at Wards. Every article listed in this catalog must pass Wards "Bureau of Standards" tests, and 65 years of successful business on a "satisfaction or your money back" policy is your guarantee of quality. Order your equipment from Wards, pay for it as you use it with Wards Time Payment Plan and know that you are getting the best at the lowest prices! Mail the coupon today.

MONTGOMERY WARD
9 GREAT MAIL ORDER HOUSES
580 RETAIL STORES

Montgomery Ward & Company
Dept. RZ-21, Chicago, U. S. A.
Please rush me New 1939 Radio Catalog FREE!



Name.....
Address.....
City..... State.....

A REAL CHRISTMAS GIFT—
A Slide Rule Everyone Will Prize



Features: Nickel Silver framed indicator with insulating pocket carrying case for convenience and protection. Scales calibrated directly on well-seasoned wood. Retains accuracy regardless of temperature or humidity changes.

Instructions and illustrations of primary operations clearly related on reverse side of rule for ready reference or teaching. Each rule with a durable pocket carrying case for convenience and protection. We offer an eight inch, white wood, accurate slide rule with A, B, C, D, E and K Scales, a 20-page Book of Instructions, How to Use a Slide Rule, a 30-page Book of 300 Examples and Answers, a two-toned Facsimile of the Declaration of Independence, suitable for framing, and an 8-page catalog illustrating and describing interior finishes and many unusual items, all five pre-ordained anywhere in the United States and Canada for **50c**

BEAUTIFUL CHRISTMAS CARDS at Wholesale Prices

21 Assorted Old English color print and engraved cards with envelopes to match, packed in attractive holiday boxes, parcel post prepaid in U. S. and Canada. Guaranteed to please or money back. (Retail Value \$2.10) Your Cost **75c**

GOLD SHIELD PRODUCTS
Dept. RC, 350 Greenwich Street, New York City

MAKING A SERVICEMAN'S TEST UNIT —THE "SUPER-GENO-SCOPE"

(Continued from preceding page)

EXTRA! BIG MONEY SAVING CATALOG
BARGAIN BULLETIN Just off the press

JUST A FEW OF 500 ITEMS AT NEW LOW PRICES

New 1939 Camden 5 Tube RADIO-PHONE COMBINATION
Superb performance. Police calls and broadcast pickup. Plays up to 12" records. Dynamic Speaker. Walnut finish. Each \$16.95. Lots 3 net each **\$15.95** with tubes

FLEETWOOD ELECTRIC RAZOR
Sensational Value! Quick, clean shaves without brush, blades or lather. No cuts. No irritation. AC. Net each **\$1.59**

AIRMASTER 1939 5 TUBE AC-DC RADIO
Highest "Little Radio" Value. Amazing volume, superb tone. Illuminated airplane dial. Dynamic speaker. Range 540-1750 KC. In rich walnut cabinet. **\$6.95** with tubes

MAIL THIS COUPON FOR FREE CATALOG

RADIO CIRCULAR CO.
915 Broadway, New York, N. Y.
Rush Free Copy of BARGAIN BULLETIN. No obligation.
Name
Address
City State

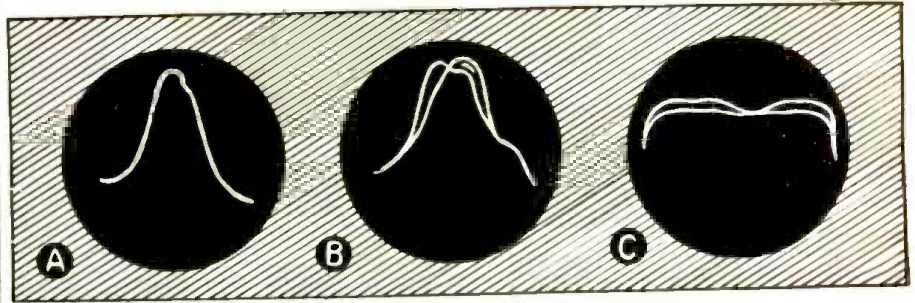

Fig. 3. Stromberg-Carlson Hi-Fi receiver band-spread I.F. oscillograms.

- One Sprague condenser, 0.002-mf., 600 V., C5;
- One Solar mica condenser, 500 mmf., C6;
- One Solar mica condenser, 100 mmf., C7;
- One Solar mica condenser, 0.001-mf., C8;
- One Solar mica condenser, 150 mmf., C9;
- Two Sprague condensers, 0.005-mf., C11, C15;
- Three Aerovox condensers, 0.25-mf., 200 V., C12, C13, C33;
- Two Aerovox condensers, 0.01-mf., 600 V., C18, C19;
- One Aerovox condenser, 0.1-mf., 200 V., C20;

- One Sprague condenser, 0.25-mf., 400 V., C21;
- One Aerovox condenser, 0.25-mf., 400 V., C22;
- One Aerovox condenser, 5 mf., 50 V., C23;
- One Solar mica condenser, 300 mmf., C24;
- One Solar condenser, 10 mf., 35 V., C25;
- Six Aerovox condensers, 0.05-mf., 400 V., C26, C27, C31, C32, C34, C35;
- Two Aerovox condensers, 8 mf., 600 V., V.W., C28, C29;
- One Aerovox condenser, 4 mf., 200 V., C30.

RESISTORS

- Four I.R.C. variable control resistors, 0.5-meg., R1, R7, R15, R16;
- Three resistors, 1,000 ohms, 1/2-W., R2, R8, R34;
- Two I.R.C. resistors, 0.1-meg., 1/2-W., R3, R6;
- Two I.R.C. resistors, 0.15-meg., 1/2-W., R4, R5;
- One I.R.C. resistor, 11,000 ohms, 1/2-W., R9;
- One Yaxley variable resistor, type 1, 4,000 ohms, R10;
- One I.R.C. resistor, 0.25-meg., 1/2-W., R11;
- Two I.R.C. resistors, 2 megs., 1/2-W., R12, R18;
- One I.R.C. resistor, 0.25-meg., 1/2-W., R13;
- One Yaxley variable resistor, type 1, 4 megs., R14;
- Two I.R.C. resistors, 30,000 ohms, 1/2-W., R17, R19;
- Four I.R.C. resistors, 0.5-meg., 1/2-W., R20, R33, R35, R36;
- One I.R.C. resistor, 20,000 ohms, 1 W., R21;
- Two I.R.C. resistors, 0.124-meg., 1/2-W., R22, R32;
- One I.R.C. resistor, 65,000 ohms, 1 W., R23;
- One I.R.C. resistor, 20,000 ohms, 2 W., R24;
- One I.R.C. variable resistor, type A, 3,000 ohms, R25;
- One I.R.C. variable resistor, type A, 50,000 ohms, R26;
- One I.R.C. resistor, 30,000 ohms, 1/2-W., R27;
- One I.R.C. variable resistor, type A, 25,000 ohms, R28;
- One I.R.C. resistor, 25,000 ohms, 1/2-W., R29;
- One I.R.C. resistor, 0.1-meg., 1/2-W., R30;
- One I.R.C. resistor, 300 ohms, 1/2-W., R31;

SWITCHES

- Two Cutler-Hammer D.P.D.T. switches, Sw.1, Sw.2;
- One Yaxley 3P.3T. rotary switch, Sw.3;
- One Yaxley D.P.3T. rotary switch, Sw.4;
- Two Yaxley D.P.D.T. switch, neutral pos., Sw.5, Sw.6;
- One I.R.C. switch plate, single-circuit, Sw.7.

MISCELLANEOUS

- One United Transformer Company synchronous transformer, A transformer, chrome shield type C1 (1 grid lead open—use c-t. and 1 grid lead), T1;

(Continued on page 382)

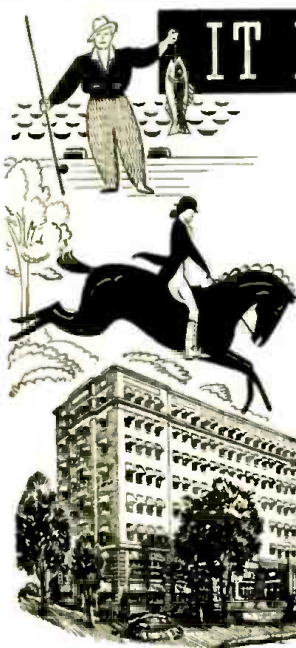

IT PAYS TO PLAY...

HOT SPRINGS NATIONAL PARK · ARKANSAS

Add years to your life by spending some time regularly in healthful exercise and toning up the system. Enjoy the refreshing mountain climate and all forms of sport and recreation. Benefit from bathing in the famous medicinal waters of the 47 U. S. Government supervised Hot Springs.

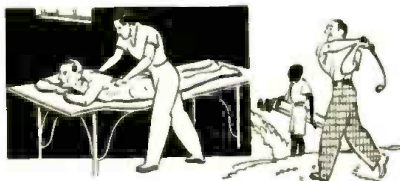

MAJESTIC HOTEL, APARTMENTS & BATHS

Stay at the new, modern Eastman Hotel! Enjoy the quiet of its vast private park - and the convenience of its ideal location! 500 large, comfortable rooms. -from \$2.50.

EASTMAN HOTEL AND BATHS

Write for descriptive literature.

C. EMMETT KARSTON,
Manager

Stop at the Majestic Hotel for fine accommodations - single rooms, with or without bath, and beautifully furnished 2, 3 or 4 room apartments. Government-supervised bath house in connection. Rates moderate, from \$1.50...Two restaurants.

R. E. M'EACHIN Manager



SOUTHWEST HOTELS, Inc. H. GRADY MANNING, Pres.

"CASH REGISTER" TUBE TESTER!

(Continued from page 344)

pletely test your customer's tubes yet do it without recourse to complicated or "tricky" time-wasting switching circuits.

Each vertical row of pushbuttons controls a separate function. The 1st row controls the proper setting of the tester's transformer primary so that it may be accurately matched to line voltage conditions in your community.

The 2nd row controls the proper filament voltage which must be applied to each tube.

The 3rd and 4th rows allow you to apply this voltage to the proper tube terminals as this also varies with different types of tubes.

The 5th row connects the proper test voltage and circuit to the tube. The 6th, 7th and 8th rows control the proper standard setting for a good tube. Each pushbutton on the last row connects to a separate tube element and by pressing each in succession, shorts and leakages between any 2 elements are easily detected on the big neon lamp.

To obtain a quality reading, either one or two buttons are pressed and "presto!", the meter indicates the tube's cathode electron flow (quality). Some tubes have 2 sections just the same as some rectifier tubes which have two plates. A separate check is made in both cases whenever necessary so that you are sure the results you see are right.

Therefore, although the above is an explanation of what happens when you test a tube, this or other technical information is not necessary for you to test any tube. You merely push buttons numbered exactly like a standard adding machine key board and according to the information given on the tube chart.

The pushbutton tube tester uses a radically new application in rotating tube charts. The chart itself is 11 feet long! This permits large figures and letters to be used. Each number refers to the pushbutton row directly beneath! No hunting all over the panel for elusive controls—because everything is right at your finger tips, just like an adding machine.

Note the schematic diagram, Fig. 1. Each vertical row of pushbuttons lettered "Gang A", "Gang B", etc., corresponds to its relative position from left to right on the tester's keyboard. The small encircled numbers correspond to the numbers on the push-buttons themselves.

PROCEDURE

To set up the tube tester so that it will accurately match your line voltage, you (1) place the tester's A.C. plug in a convenient wall socket, (2) while holding down the button marked "L", "Line adj.", on diagram push the bottom brown button in the first vertical row. The meter dial will light up and the needle will indicate at some point less than center scale (the middle of the orange portion of the scale). Now, depress each button in turn above the bottom brown button until the needle rests closest to half-scale. You will note that as you press each button in a row, the previously pressed button will be released. When the needle indicates half-scale, the tester is adjusted to the line and you are ready to test tubes. Release the "L" button which is momentary and it will return by itself. This line adjustment is done only at the first of each day's work. However, from time to time it is advisable to re-press the "L" button so as to recheck and see if your supply is maintaining the same voltage. If the needle doesn't return to about half-scale, depress the pushbutton in the first row immediately above

or below the one you already have depressed so as to bring the needle back to about half-scale.

Let's assume we are going to test a 01A tube. You need only (1) Look at the tube and determine (a) whether it is an octal or non-octal tube, (b) its type number. (2) Rotate the tube chart to the corresponding type number found all the way to the left on the tube list. You will find a series of numbers after the tube type, each number being directly above a row of pushbuttons. Depress the pushbutton in each row which corresponds to the number directly above it on the tube chart.

"Q" QUALITY TEST

After depressing all the buttons called for on the tube type listing, insert the tube in the proper socket (you can't put it in the wrong socket because it will fit only in the correct one). Let the tube warm up for about 5 to 15 seconds. The average warm-up time is 10 seconds on most types but some are faster or slower. Then depress the button marked "Q" and observe the meter reading ("Good", "?", or "Bad"). If the needle continues to climb slowly, the tube is not completely heated. If the needle is stationary, the tube has reached its proper operating temperature and the reading on the scale can be taken as correct. If the needle vibrates violently at about 1/5 full scale, the tube is shorted and should be replaced.

Some tubes require 2 quality tests to check all elements and these tests are marked "Test A" and "Test B" on the chart. For such tubes, check both ways and if either test shows the tube as "bad," it should be replaced.

Tubes which have internal leakages or shorts may test good in quality test but not be satisfactory for radio reception. Therefore, after taking the quality test, release the "Q" button (this is also a momentary-type pushbutton) and, starting with top or "9" button in the last row, depress each button in turn down the line while watching the neon lamp. If the lamp lights on both plates and stays lighted during the time any button in the last row is depressed, the tube has an internal short or leakage and should be replaced even if it passes a quality test.

In order that certain of the tuning indicator tubes such as the 6E5, 6G5, 2E5, 2G5, etc., be tested properly, an additional pushbutton marked "C", should be depressed during the quality test of these tubes. Both are momentary and will return to the normal position when you release them.

"OPEN" TEST

While tubes with open elements (other than filament) are an extreme rarity, it is interesting to know how to test for them on this tester. Remember, you need not take the time to make this test on every tube as you will not find one tube in a thousand with this defect. However, in rare cases, a tube will pass all checks and still may not operate properly in a radio set. Under this condition a check for an open element can be made as follows:

Set up the tester pushbutton for a regular test. Depress the "Q" button and note the reading. While holding down the "Q" button and any button or buttons in the last row which were indicated on the chart for the particular tube type under test, push down the balance of the buttons one by one, meanwhile watching the action of the meter needle. As each button is depressed the meter needle should drop back somewhat.

(Continued on page 381)

QUICK, EASY MEASUREMENTS—
SENSATIONAL HICKOK "JUMBO"
VOLT OHM MILLIAMMETER
with 9" METER

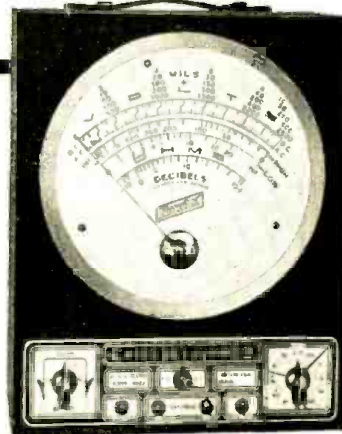

WIDE COVERAGE—AC—DC Volts, DC Microamperes, D.C. Milliamperes, Resistance, Decibels, Output. Highly sensitive movement. Scale over 7" long, easily read from any angle. Rugged. HICKOK built thruout. Exceptionally low price for high quality instrument.

Mail coupon for full information.

HICKOK ELECTRICAL INSTRUMENT CO.,
CLEVELAND, OHIO

HICKOK ELEC. INSTRUMENT CO.,
10401 DUNN AVENUE, CLEVELAND, OHIO

Gentlemen: Send information on "Jumbo"
Volt Ohm Milliammeter.

Name

Address

City & State

TELETRAN

!!!

MOST COMPLETE
LINE OF P.A.
and ACCESSORIES
ON THE MARKET
TODAY.



Write for 20-page Catalog.

*

Licensed by ERPI under patents owned or
controlled by A. T. & T. and Western
Electric

TELETRAN PRODUCTS CO.

2233 University Ave.

St. Paul

Minnesota

STOP, LOOK & BUY!

Rockbottom Prices on Surplus, and Army and Navy Merchandise

When prices are low we buy! They're low now—LOWER THAN THEY EVER WILL BE—hence this sale. Most of the merchandise is new—never used; some of it reconditioned. 100% satisfaction on each transaction or your money refunded.

ORDER FROM THIS PAGE. Use the convenient coupon below. Be sure to include sufficient extra remittance for parcel post charges, else the order will be shipped express, charges collect. Any excess will be refunded. C.O.D. shipments require a 20% deposit. If full remittance accompanies order deduct 2% discount. Send money order—certified check—new U. S. stamps. No C.O.D. to foreign countries.

ORDER TODAY QUANTITIES LIMITED QUICK SHIPMENTS ASSURED

EDISON 1/50TH H.P. UNIVERSAL MOTOR

Made by Edison Electric Co. for Dictaphone machines. Can be used on 110 volt D.C. or A.C. lines (any frequency on A.C.). Double speed 3/16th in. diam. Any speed obtainable with suitable rheostat. Size 9" x 1 1/2" high x 2 1/2" wide overall. Shp. Wt. 8 1/2 lbs.



ITEM NO. 10
Your price \$2.25

NEW FUEL PUMPS

Brown & Sharpe pumps. Brand new; never been used. Can be used for gasoline, oil, kerosene, and other fuels. Not good for water. Takes standard thread 1/2" input and output pipes. Has 1/4" drive shaft. Measures 4 x 3 3/4 x 3 1/4" diam. overall. Shp. wt. 1 1/2 lbs.

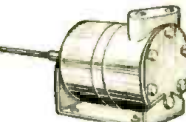

ITEM NO. 24
Your Price \$4.45

WESTERN ELECTRIC BREAST MIKE

A lightweight aircraft-type carbon microphone, with breast plate mounting. Can be adapted for home broadcasting or private communication systems. With cord and plug. Shp. Wt. 4 lbs. (Illustrated at right).



ITEM NO. 14
Your Price \$2.45

Magnavox Anti-Noise Microphone, also used for home broadcasting, etc. With cord and plug. Shp. Wt. 2 lbs.

ITEM NO. 15
Your Price \$1.80

U. S. NAVY BAUSCH & LOMB TELESCOPE

Precision-built for U. S. Navy use as finders on large calibre guns. CAMERA FANS—USE IT FOR CLOSE-UPS OF DISTANT PICTURES. Optical system comprises 7 lenses and erector and eyepiece draw tubes. Object lens 2" variable; eye lens 1 1/2"; exit pupil 0.2" to 0.06"; Angular field 3°30'; power 3 to 10; erect image; cross hairs used. Net wt. 6 lbs. Original cost said to be over \$130. Shp. wt. 10 lbs.



ITEM NO. 25
Your Price \$14.95

GUARANTEED REBUILT VACUUM CLEANERS

ALL NATIONALLY-KNOWN makes—GUARANTEED FOR 6 MONTHS. All parts, no matter how slightly worn, are replaced with NEW ones—we supply new bags, new cords, brushes, handles, belts and other parts. Even the chassis itself is replated and polished. We've been selling these rebuilt machines since 1930; all our customers are satisfied, or money back. THERE'S NO GRIEF WITH THESE MACHINES!

EUREKA NO. 9—Straight suction. Fixed brush. Pistol grip handle. Switch in handle. Polished aluminum housing, 13-inch nozzle. Shp. wt., 20 lbs. List Price, \$32.50

ITEM NO. 26
Your Price \$12.95

HAMILTON BEACH—Motor driven brush. Pistol grip handle. Polished aluminum housing, 12-inch nozzle. Switch in handle. Shp. wt., 20 lbs. List Price, \$30.50

ITEM NO. 27
Your Price \$13.95

HOOVER NO. 105—Motor driven brush. Four control switch. Black enameled steel motor housing, 12-inch nozzle. Shp. wt., 24 lbs. List Price, \$63.50

ITEM NO. 28
Your Price \$13.95



PREMIER DUPLEX—Motor driven brush. Pistol grip handle. Switch in handle. Polished aluminum housing, 13-inch nozzle. Ball bearing motor. Shp. wt., 20 lbs. List Price, \$30.00

ITEM NO. 29
Your Price \$16.95

ELECTROLUX NO. 11—Radical design. Cylinder type motor. Complete with all attachments. Foot control switch. Has 101 uses: cleaning upholstery, walls, draperies, curtains, mattresses, etc. Shp. wt., 18 lbs. List Price, \$69.75

ITEM NO. 30
Your Price \$18.95

HOOVER NO. 700—Agitator type cleaner. Pistol grip handle. Switch in handle. All high polished aluminum finish. Ball bearing motor. Shp. wt., 25 lbs. List Price, \$74.50

ITEM NO. 31
Your Price \$29.50

PORTABLE TELEGRAPH AND BUZZER FIELD SETS

Made for military use by Western Electric. A wonderful buy if only for the data it contains. New—never been used. Good for code practicing, signaling, communications, etc. Contains 2-tone, high-frequency buzzer with platinum contacts, telegraph key, telephone switches, surplus condenser, transformers, chokes, etc. A \$50 value easily. Complete in wooden case with diagrams and instructions. Shp. Wt. 12 lbs.



ITEM NO. 16
Your Price \$5.45

TELEGRAPHIC TAPE RECORDER

A wonderful buy! Apparatus makes a written record of code and similar messages on paper tape. An ideal machine for learning code or teaching code to groups. Radio men can easily adapt it to short-wave receivers for taking permanent records of code messages. Double lens permits simultaneous recording of two messages. Pens are operated by battery and key white tape feeder. Case made of solid brass on heavy iron base. Completely reconditioned. (Tape can be obtained anywhere.) Original cost \$85.00. Shp. Wt. 20 lbs.

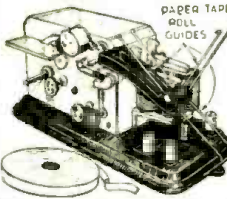

ITEM NO. 20
Your Price \$19.95

SPERRY GYROSCOPE LIQUID COMPASS

Made for U.S. Signal Corps; sensitive and accurate. Quick readings easily made from lens; accurate readings of fractions through focusing magnifying lens on side of instrument. Complete with level sights and magnet carrying case. Excellent for boats, boy scouts, campers, hikers, etc. A few turns of wire around its case makes it usable as a galvanometer. Shp. Wt. 3 lbs.



ITEM NO. 12
Your Price \$1.85

ANTI-CAPACITY SWITCHES

Made by Western Electric. Double throw switch with 12 terminals—equivalent to two double-pole, double-throw switches. All contacts are of platinum plate. Original price \$3.50 each. Shp. Wt. 1 lb.



ITEM NO. 23
Your Price \$1.55

WE HAVE NO CATALOG. ORDER FROM THIS PAGE.
HUDSON SPECIALTIES - 40-R West B'way - N.Y.C.

IT'S EASY TO ORDER—CLIP COUPON—MAIL NOW

HUDSON SPECIALTIES CO., 40-R, West Broadway, New York, N. Y. RC-1238

I have circled below the numbers of the items I'm ordering. My full remittance of \$..... (include shipping charges) is enclosed.
OR my deposit of \$..... is enclosed (20% required), ship order C.O.D. for balance. (New U.S. stamps, check or money order accepted.)

Circle item No. wanted: 10 12 14 15 16 20 23 21 25 26 27 28 29 30 31

Name Address

City State

Send remittance by check, stamps or money order; register letter if you send cash or stamps.

OPPORTUNITY AD-LETS

Advertisements in this section cost five cents a word for each insertion. Name, address and initials must be included at the above rate. Cash should accompany all classified advertisements unless placed by an accredited advertising agency. No advertisement for less than ten words accepted. Ten percent discount for six issues, twenty percent for twelve issues. (Objectionable or misleading advertisements not accepted. Advertisements for January, 1939, issue must reach us not later than November 5th.)

Radio-Craft • 99 Hudson St. • New York, N. Y.

AGENTS WANTED

INDIAN RELICS, BEADWORK, COINS, CURIOS, Minerals, old glass. Catalog 6c. Indian Museum, Northbrook, Kansas.

SALESMEN—SELL CALENDARS, COMPLETE LINE, all sizes, including jumbos; beautiful subjects. Samples free! Fleming Calendar Co., 6539 Cottage Grove, Chicago.

MEN—WOMEN SELL THE NEW BULMER CORN DE- cutter. Makes corn cutting easy. Bulmer Machine Works, Bellukham, Wash.

AVIATION

AIRPLANE MECHANIC'S LICENSE QUESTIONS, with answers, diagrams, \$1.25. Engine Mechanic's \$1.25. Both \$2.00 remittance. Meyer Engineering, Box 8, Hempstead, New York.

BOOKS AND MAGAZINES

WE HAVE A FEW HUNDRED RADIO ENCYCLO- pedias, by S. Gernsback, second edition, originally sold at \$3.98. Book has 352 pages, weight 3 lbs., size 9 x 12 inches. Red maroon—keratin flexible binding. Send \$2.49 in stamps, cash or money order and book will be forwarded express collect. Techifax, 558 W. Washington Blvd., Chicago, Illinois.

ASSURE YOURSELF OF GREATER PROFITS BY doing radio service jobs more quickly. Authentic service guides show you the way to locate and correct troubles in any radio receiver. Gernsback Official Radio Service Manuals show you how to complete more repair jobs in less time—how to earn more money by faster servicing. Turn to page 324 and learn how you can get manuals on a free inspection plan.

USED CORRESPONDENCE COURSES AND INSTRU- ction books bought, sold, rented, exchanged. Catalog free. V. W. Vernon, Henagar, Alabama.

BUSINESS OPPORTUNITIES

RELIABLE PERSON IN EACH TOWN FOR OWN advertising distributing agency. No selling. Good paying business. Dawson's Advertising, Cape Girardeau, Missouri.

YOUR FAVORITE CIGARETTE, 69c A CARTON OF 200 cigarettes. Plan 25c and stamp. J. J. Frank, 325-L Palm, Rockford, Ill.

CAMERAS & SUPPLIES

AMBERTINT 16MM. CAMERA FILM \$1.85 FOR 100 feet including machine, in waxed light Bulbitt loading. Weston & Hollywood Studios, South Gate, Calif.

JOIN THE THOUSANDS OF CANDID CAMERA FANS—a scouting binocular equipped with Wollensak 50 mm. lens, speed shutter and accurate "spy glass" view finder. Fixed focus assures sharp pictures 1 1/2 x 1 1/4 inches. Enlarges with clarity up to 8 x 10 inches. Has special compartment to carry extra film roll and tripod socket for mounting. Uses economical Kodak 127 or Agfa Ad film in color or black and white—takes 16 pictures. Housing built of unbreakable bakelite composition. Camera weighs only 9 ounces; measures 5" long by 3" high by 2" wide. Easy to operate and inexpensive to use. Shipped postpaid anywhere in U.S.A. with guarantee of safe delivery—\$3.98. Hulston Specialties Company, 4810 West Broadway, New York, N. Y.

COINS AND STAMPS

25 NORTH AMERICAN, ETC. FOR 10c. PRICE LISTS, Approvals, Box 191, Gloucester, Mass.

EARN CASH, STAMPS, SELL MY APPROVAL BOOKS—nickel packets. Mort. Ellis, 2841 West 33rd Street, Brooklyn, New York.

A. C. GENERATOR

NEW 110 VOLT A. C. FANBELT GENERATORS FOR portable power, 8 sizes. Write Loday Manufacturing, 151 Loday Bldg., Minneapolis, Minn.

FOR INVENTORS

INVENTIONS QUICKLY COMMERCIALIZED, UNPAT- ented, protection guaranteed. Pacific Inventors Agency, 2236 Post, San Francisco, Calif.

CASH FOR UNPATENTED IDEAS, STAMP FOR PAR- ticulars. Mr. Ball, 9141-J Pleasant, Chicago, Ill.

INSTRUCTION

RADIO ENGINEERING, BROADCASTING, AVIATION and police radio, servicing, marine and Morse telegraphy taught thoroughly. All expenses low. Catalog free. Dodge's Institute, Pine St., Valparaiso, Ind.

LEARN CARTOONING FROM MY ORIGINAL DRAW- ings, first lesson free. Templeton, Lavalette, West Va.

MICROSCOPES, TELESCOPES, LENSES, ETC.

EXPERIMENTERS—ASSORTMENT IN UNMOUNTED lenses, suitable for scientific, microscopes, etc. \$1.00 postpaid. Optical Works, RC12A, Milton, Penna.

"ULTRALENS" SCOPE KIT—MAKES 3" DIAMETER 25-100 power astronomical telescope \$1.00 postpaid. Optical Works, RC12, Milton, Penna.

MISCELLANEOUS

MEXICAN DIVORCES; NO PUBLICITY, AMERICAN attorney, Box 1736, El Paso, Texas.

NAMEPLATES—ENGRAVED BAKELITE; PRICES reasonable. List free. Albert Woody, 189 M West Madison, Chicago.

HANDPAINTED PILLOW TOPS AND RADIO SCARFS on velvet; heavy satin backs \$1.00. Photostat, 857 S 89 St., Wauwatosa, Wis.

PYRO PANTAGRAPH—THIS ELECTRICAL OUTFIT burns designs permanently on leather, wood, cork, gourds, bakelite, etc. Simply plug pyro electric pencil into any 110 v. A.C. or D.C. line and it is ready to use. Reduce or enlarge any design with special pantagraph included. Complete kit and instructions, \$2.75. (Add postage for shipping 3 lbs.) Wellworth Trading Company, 560-R West Washington Street, Chicago, Illinois.

(Continued on next page)

(Continued from preceding page)

MONUMENTS AND TOMBSTONES

GENUINE MARBLE, GRANITE, FREIGHT PAID. Catalog free. \$11 up. United States Marble & Granite Co. A-27, Oneco, Fla.

OFFICE SUPPLIES

ENVELOPES—1000—6 3/4's \$1.75; 1000—10's—\$2.85; 100 sheets carbon paper \$1.50; prepaids. "Everything for the office." Lubahn, 693 Main, Evanston, Illinois.

PHOTOGRAPHY

ROLLS DEVELOPED—25c COIN, TWO 5 X 7 DOUBLE weight professional enlargements, 8 gloss prints. Club Photo Service, LaCrosse, Wisconsin.

ROLLS DEVELOPED—8 LARJAPRINTS (ENLARGEMENTS) 35c or 8 regular prints 25c. Star Photo, New Britain, Connecticut.

PRINTING

100 PRINTED RADIO CALL CARDS \$1.00. 100 double-edge razor blades \$1.00, postpaid. Olsen Press, 1531 Southeast Powell, Portland, Oregon.

699 PRESS \$5.00, BARGAIN LITERATURE FREE. Sorely Shop, Downsville, Louisiana.

RADIO

PLANS 18 DISTANCE CRYSTAL SETS—SW RECORD \$250 miles, with "Radiobuilder"—year, 25c. Laboratories, 7200-B East 14th, Oakland, Calif.

ZENITH RADIOS WHOLESALE, LIST FREE. RADIO-MAN, Box 452, Maryville, Tennessee.

BARGAINS: 5-TUBE NEW RADIO COMPLETE WITH dynamic speaker \$5.95, 7-tube superhet 12 1/2 to 35, 31 to 120, 180-750 meters \$14.95. Values cannot be duplicated. Fully guaranteed. H. G. Young, 127 Liberty Street, New York.

SELL CRYSTAL MICROPHONES, NON-DIRECTIONAL, eight ball model. Brand new latest factory product, \$8.00. White Sound Studio, 151 West 63rd Street, New York, N. Y.

FOR HARD-TO-GET RADIO PARTS, EQUIPMENT, meters, accessories, thermo-couples and repairs. B. D. Heller, 2371 Webster Avenue, New York.

SONG POEM WRITERS

WANTED ORIGINAL POEMS, SONGS, FOR IMMEDIATE consideration. Send poems to Columbian Music Publishers, Ltd., Dept. P-9, Toronto, Can.

SONGWRITERS! MELODY FOR WORDS \$1.00. Little, 215 Mason Theatre, Los Angeles, California.

"CASH REGISTER" TUBE TESTER!

(Continued from page 379)

This backward movement will vary (between buttons pressed) from 1/2-in. to a full backward movement. The main point to remember is that there should be a backward movement for each button pressed unless (1) there is no tube element connected to the button; or, (2) there is an open-circuit condition in the tube. You know that each termination on the socket has been given a number by the R.M.A. and these numbers correspond to the pushbutton numbers in the last row of the tester (No. 9 button corresponds to "T.C." or Top Cap).

In Canada and in some U. S. localities, receivers are still in use with tubes having filament terminations on the top. Special testing instructions are given for these tubes on the tube chart proper.

From time to time, new tubes are issued by the tube manufacturers. Settings for these tubes may always be obtained at intervals from the Zephyr's maker. They make up mimeographed lists of these new tubes until their number warrants a new tube chart, when that will be available also. In between issues of new tube charts, the metal bracket and celluloid cover over the chart can be loosened by removing the six small screws and the new settings put on the chart in pencil, or pen and ink. Spaces are provided throughout the chart for these additions.

Besides the approximate 400 tube test settings printed on the tube chart, there are over 300 additional tube types given on a separate tube test. These tubes are checked the same as some other tube-type on the rolling chart and each "comparative" type is shown on this list.

As you can readily see by referring to Fig. 1, extreme flexibility and proof against early obsolescence are two of this tester's biggest features. Inasmuch as there are eight rows of tube setting buttons with from 9 to 10 buttons on each row, there are approximately 20 million legitimate possible settings. Theoretically, this figure should be raised to about 100 million, but in actual practice, the lower figure is more correct.

Another interesting point to consider is the fool-proof design of the tester. Consider "Gang A" in Fig. 1. Note the series-connected switch. If this were designed only as shown in the heavy portion of the wiring in Fig. 1, the accidental depression of 2 buttons in the same row would result in a heavy drain through the transformer and possible damage to it before the buttons could be released. Series-connected switches as shown in the full diagram protect every transformer circuit and result in complete protection against carelessness.

Figure 4 shows an interior shot of the Zephyr. Note the careful placement of each part and the general neat appearance of the construction.

The circuit is patented under U. S. Patents numbers 1,916,102; 2,002,425; 2,075,415; 2,112,516, and other patents pending.

The stream-lined case of the Zephyr is finished in brown with an ivory trim. The same circuit may be obtained in a convenient portable case. The counter model uses a double-faced meter with 2 English-reading "Good-? Bad!" scales so that you and your customer each have a separate tube scale. The portable model uses a single-faced meter.

This article has been prepared from data supplied by courtesy of Supreme Instruments Corp.

You would not connect a **DOOR BELL** this way

Why a **RADIO?**

Untidy, makeshift connections between aerial and receiver are no longer necessary... give your customers



COR-NEX

DE LUXE CONNECTOR

This long-awaited invention of a veteran service man solves the connector problem! No more frayed, messy wires to spoil otherwise modern homes! In seven easy steps, you install the ultra-modern COR-NEX, you make a sweet profit on the transaction, and any housewife will thank you a million for the idea! Get busy and **MAKE SOME MONEY!**

COMPLETE—with DOUBLE-BLIT lighting arrester, decorative inside plate with leads and polarized plug with cords

\$2.50 list

Distributed through Jobbers

CORNISH WIRE CO., Inc.

30 Church Street New York City

FORMULAS AND RECIPES

For the Practical Man

Here Is the Contents of the Book

1. Adhesives; Glues, Cements, Gums, Mucillages, Lubricants.
2. Cleansing; Stain Removers, Paint Removers, Bleaches, Cleaning Fluids.
3. Metal Craft; Coloring, Oxidizing, Finishing, Repairing, Welding, Polishes, Alloys, Solders, Analogs.
4. Paints; Colors, Stains, Varnishes, Enamels, Laminous Paint, Washable Paint, Paint-Removing, Waterproofing, Fireproofing.
5. Glass-Working; Cutting, Drilling, Boring, Grinding, Blowing, Etching, Engraving, Frosting, Silvering, etc.
6. Wood-craft; Fillers, Fireproofing, Acid-proofing, Waterproofing; Furniture Polishes, Finishes, etc.
7. Inks; Recipes, Eradicators, Ink Stain Removers; Special Inks; Colored, Indelible, Sympathetic, Invisible, Heliograph.
8. Photography; Developers, Emulsions, Fixers, Sensitizing, Toning, Printing, Photographic Paper, Blueprint Paper.
9. Antidotes for Poisons, Remedies for Burns and Scalds, Disinfectants, First-Aid in Accidents, Emergency Remedies, Home Remedies.
10. Preparation, Manipulation, Handling, Mixing, Measuring, Weighing, Filtering, Straining Solutions; List of Technical Substances; Emulsifying; Use of Hydrometer, Use of Thermometer; Tables of Weights and Measures; Decimal Systems, Useful Tables.

PRICE 50c POSTPAID

Send check, cash, money order or stamps.

TECHNIFAX

Division RC-1238

558 W. WASHINGTON BLVD., CHICAGO, ILL.

It's Your Job Today

to prepare for a better radio job tomorrow!

You need something more than just "good intentions" to get ahead in Radio. Today's opportunities go to the men with **TECHNICAL TRAINING**. Our "Tested Plan for a Future in Radio" tells how YOU can improve your position. Write for your **FREE COPY** right now to—

CAPITOL RADIO ENGINEERING INSTITUTE

Dept. RC-12A 3224-16th St., N.W. Wash., D. C.

Announcement of Winners in the **Radio-Craft Tenth Anniversary Prize Contest**

Winners of the **OFFICIAL RADIO SERVICE HANDBOOK**, by J. T. Bernsley are as follows:

S. J. Currie, Box No. 135, Huntingdon, Prov. Quebec, Canada.

A. Bianchino, 205 No. 20 Street, Herrin, Illinois.

Merrill J. Daste, 1665 Humanity Street, New Orleans, La.

Frank Uzella, Jr., 310 Barney Street, Wilkes-Barre, Pa.

John T. Frye, 1810 Spear Street, Logansport, Indiana.

W. C. Harmon, 103 Main Street, Homer City, Penna.

J. Eduson, 190 Cherry Street, Buffalo, N. Y.

Armand Hesse, 7819 Ladeunesse, Montreal, Que., Canada.

George Rogers, 617 Cumberland, Little Rock, Arkansas.

E. B. DeWitt, Route No. 2, Petersburg, Virginia.

W. W. Blitchie, Elkhart, Illinois.

Thomas C. Rimney, 36 Fuller Ave., Toronto, Ont., Canada.

B. F. Mills, 1811 Central Ave. W., Bl. No. 1, Great Falls, Mont.

G. M. Booth, General Delivery, Trenton, Ont., Can.

Clarence J. Taber, Box No. 314, Bluefield, Virginia.

Andy K. Vailo, 807 Oak Terrace, Monaca, Penna.

W. J. Blonkin, 4305 Caribou Street, Vancouver, B. C., Canada.

Isaac S. Blander, Station 19, Waterford, Conn.

R. E. McKerral, 4 West Church St., Marshalltown, Iowa.

Alec Frelk, Kinderhook, New York.

Winners of a One-Year Subscription to **RADIO-CRAFT** are as follows:

Lloyd T. Erlsman, 4801 Lafayette Avenue, Little Rock, Ark.

Lyle C. Ragan, Box No. 36, Metz, Missouri.

Edward A. Turner, P. O. Box No. 757, Hoboken, N. J.

G. H. Jeffries, 326 W. Vermont St., Salem, Ill.

Fred Utz, 225 South Marengo, Alhambra, California.

John Mangrum, 415 South State Street, Big Rapids, Mich.

Frank Sanatore, 312 First N. E., Massillon, Ohio.

Alvin E. Brough, Springwater, New York.

H. B. David, 4150 Railroad Avenue, Brentwood, Md.

Chester L. Wheeler, Jr., 4 Park Street, Milford, N. H.

Garah Richardson, 110 West LaPorte St., Plymouth, Ind.

Ralph C. Welch, Tisdale, Sask., Canada.

Elwin K. Bruce, 4233 Clay St., N. E., Washington, D. C.

Wilmer H. McKen, Box J, Lorile, Sask., Canada.

Victor J. Dunley, 517 Eleventh St., Franklin, Penna.

H. T. Holtan, Jenner, Alberta, Canada.

Lester Mulvey, 13 Mill St., Lynn, Mass.

R. H. Jurgens, 204 Egan Avenue N., Madison, S. Dak.

Alex Atkinson, 3430 Edison, Detroit, Michigan.

Alton H. Bowman, Box No. 33, Chapin, N. Y.

W. Ward, 149 East 89th St., New York, N. Y.

Felix A. Wolovich, Bartonville, Ont., Canada.

Ray W. Winter, 418 W. Erna St., La Habra, Calif.

Norcer Morarty, Marlin, So. Dak.

W. G. Bretz, Shelburne, Ontario, Canada.

William Schmeier, 137 St. Felix St., Brooklyn, N. Y.

Roger H. Herrel, Wahoo, Nebraska.

Guy T. Burkin, Jr., 239 East 2nd St., Pass Christian, Miss.

Leon I. Mond, 891 Southern Blvd., New York, N. Y.

R. D. Hoovers, 315 Van Buren St., Wilmington, Dela.

Please Say That You Saw It in RADIO-CRAFT

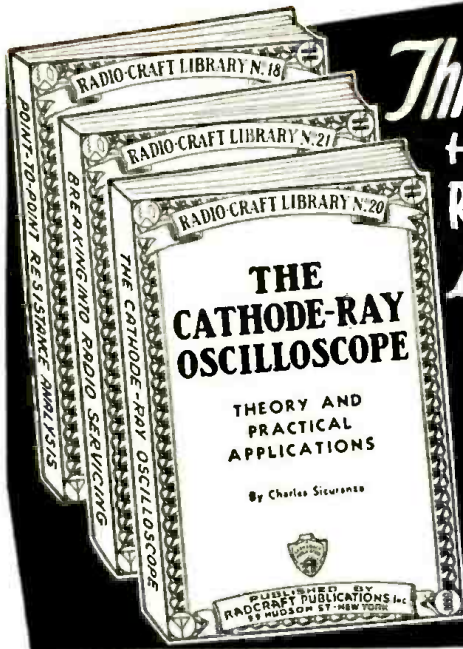

Three NEW Books
HAVE BEEN ADDED TO
RADIO'S MOST COMPLETE
Low-Priced **LIBRARY**
EACH VOLUME **50¢**
The New Titles -
POINT-TO-POINT RESISTANCE ANALYSIS
BREAKING INTO RADIO SERVICING
THE CATHODE-RAY OSCILLOSCOPE

GET into the swing of reading more books on important radio subjects—it's the easiest, quickest and most inexpensive way to add to your radio knowledge. New titles, continually being added to the RADIO-CRAFT LIBRARY SERIES, keep you posted on new developments. Three timely books, titles shown above, are now ready covering radio's latest advances. Read them without delay. Each book is exceptionally low in price—fifty cents a volume, and contains 64 pages, with illustrations varying from 50 to 150. To order any books use the coupon below—clip and mail today. A special saving for you! ALL BOOKS ARE SENT POSTPAID TO YOU.

Here Are the Titles

Book No. 2
MODERN VACUUM TUBES
 And How They Work with Complete Technical Data on All Standard and Many Special Tubes
 By ROBERT HERTZBERG

Book No. 3
THE SUPERHETERODYNE BOOK
 All About Superheterodynes How They Work. How to Build and How to Service Them
 By CLYDE FITCH

Book No. 6
BRINGING ELECTRIC SETS UP-TO-DATE
 With Pentodes, Multi-Mus, Dynamic Speakers—Complete Information on How to Modernize A.C., D.C., and Battery-Operated Receivers
 By CLIFFORD E. DENTON

Book No. 8
RADIO QUESTIONS AND ANSWERS
 A Selection of the Most Important of 5,000 Questions Submitted by Radio Men During the Course of One Year

Book No. 9
AUTOMOBILE RADIO AND SERVICING
 A Complete Treatise on the Subject Covering All Phases from Installing to Servicing and Maintenance
 By LOUIS MARTIN

Book No. 10
HOME RECORDING AND ALL ABOUT IT
 A Complete Treatise on Instantaneous Recordings, Microphones, Recorders, Amplifiers, Commercial Machines, Servicing, etc.
 By GEORGE J. SALIBA

Book No. 12
PUBLIC ADDRESS INSTALLATION AND SERVICE
 Modern Methods of Servicing and Installing Public Address Equipment
 By JOSEPH T. BERNSELY

Book No. 13
ABC OF AIR CONDITIONING
 An Accurate Simplified, Technical Review of the Fundamentals of This Latest Branch of Engineering, Including Servicing Data on Present-day Units
 By PAUL D. HARRIGAN

Book No. 14
POCKET RADIO GUIDE
 Handy Reference Book for Radio Men—Set Construction Articles—Audio Amplifier Circuits—Useful Radio Formulas and Data—Handy Short Cuts—Index to Important Articles Printed in Radio-Craft Magazine
 By N. H. LESSEM

Book No. 15
ABC OF REFRIGERATION
 A Compendium of the Principles of Refrigerating for Service Men with a Detailed Listing of Defects and How to Overcome Them, with Hints on Setting Up a Service Shop
 By TRAFTON MASON

Book No. 16
PRACTICAL RADIO CIRCUITS
 A Comprehensive Guide to All Types of Radio Circuits for the Service Man, Constructor and Experimenter
 By DAVID BELLARE

Book No. 17
SERVICING WITH SET ANALYZERS
 A Study of the Theory and Proper Applications of Modern Set Analyzers and Associated Apparatus
 By H. G. McENTEE

Book No. 18
POINT-TO-POINT RESISTANCE ANALYSIS
 Theory—And Application of This Modern Test Procedure in Every-day Radio Service Problems
 By BERTRAM M. FREED

Book No. 20
THE CATHODE-RAY OSCILLOSCOPE
 Theory and Practical Applications
 By CHARLES SICURANZA

Book No. 21
BREAKING INTO RADIO SERVICING
 Simple Instructions and Procedure for Starting a Profitable Radio Business of Your Own
 By ROBERT EICHBERG

RADCRAFT PUBLICATIONS, INC. • 99 HUDSON ST. • NEW YORK, N. Y.

CLIP COUPON — AND MAIL TODAY!

RADCRAFT PUBLICATIONS, INC., Dept. RC-1238, 99 Hudson St., New York, N. Y.
 I have circled below the numbers of books in the RADIO-CRAFT LIBRARY SERIES, which you are to send me POSTAGE PREPAID. My remittance of \$..... is enclosed at the cost of fifty cents for each book. (Stamps, checks or money orders accepted.)
 Circle numbers wanted: 2 3 6 8 9 10 12 13 14 15 16 17 18 20 21
 Name Address
 City State
 Send remittance by check, stamps or money order; register letter if you send cash or stamps.

Please Say That You Saw It in RADIO-CRAFT

NEW CIRCUITS IN MODERN RADIO RECEIVERS

(Continued from page 352)

or strong-signal stations will be tuned-in automatically, as often as every 15 minutes if desired.

From some of the usual contacts bearing on the tuning condenser selector drum, there are leads which connect to terminals on a contact carriage as in Fig. 2A. This contact carriage is driven over "station timer slides" fitted with 6 slots for 48 contacts each. The contact carriage is driven by a synchronous clock motor so that it covers the time sliders once in 12 hours. It then reverses and covers them again in the next 12 hours. While all contacts are made every 12 hours, there is an A.M.-P.M. switch provided so that the circuit may discriminate between the A.M. and P.M. settings.

To overcome the inherent inaccuracy of the contacting made in this manner, an accurate timing switch is placed in series with the common return. The contactors simply close the tuning motor circuit in the same way that the keyboard buttons do—but automatically and at the appointed time.

(5) A PHASE INVERTER SYSTEM USING CATHODE LOADING

Emerson Models BR-266 and BR-227.
 An unconventional phase inverter system in which the signal circuit includes only one capacity with four tubes in parallel-push-pull for the output is described.

The circuit is very simple with reference to what it accomplishes. Its complete circuit from the 6Q7 triode 1st A.F. output is shown in Fig. 2B. Signals are fed to the first two 6J5's substantially in phase, the output of the first having its load in the cathode side of the complete plate circuit. Both load resistors are 25,000 ohms to achieve a good gain from each tube feeding into the parallel-push-pull amplifier. Furthermore, because of the bias requirements of the 6J5's their cathodes are operated somewhat positive at which potential the grids of the 6AC5G's are intended to operate. An additional tube is, of course, used at reduced input for phase inversion.

The system is fitted with a tone control and a coupling condenser to boost high frequencies to the inverter section.

MAKING A SERVICEMAN'S TEST UNIT—THE "SUPER-GENO-SCOPE"

(Continued from page 378)

- One United Transformer Co. power transformer, 450-0-450 V., 6.3 V., 5 V., type 913, T2;
- One filament transformer, 6.3 V., T3;
- One choke, 30 hys., 450 ohms, L3;
- Two Meissner shielded R.F. chokes, 80 mhys., L1, L2;
- Two RCA type 6J7 metal tubes, V1, V4;
- One RCA type 884, gas-triode, V2;
- One RCA type 902 cathode-ray tube, V3;
- One type 80 rectifier, V5;
- One RCA type 6H6 demodulator metal tube;
- One RCA type 6C5 external amplifier metal tube.
- Four American Radio Hardware automobile antenna connectors, J1, J2, J3, J4;
- Three demodulator-unit antenna connectors (A), J5, J6, J7;
- Five 8-brong sockets (demodulator amplifier), V1, V2, V4;
- One Eby 4-brong socket;
- One Amphenol adapter assembly for V3;
- Six Crowe dials, 0-100, 1 1/4 ins. dia., No. 263.
- Plate for COARSE FREQUENCY ADJUSTMENT (Sw.4) supplied with switch. Plates for SYNC. and SWEEP (made to order);
- Two Crowe knobs without pointers, No. 284;
- Six Crowe knobs with pointers, No. 591;
- One front panel fuse holder;
- Note: Part II will contain the List of Parts for the "Super-Geno" unit.

EXPERIMENTS WITH MULTIVIBRATORS

(Continued from page 349)

under conditions of optimum load. In Fig. 4D, we changed the resistance load to inductive load (headphones) and with the same 60-cycle sine injection obtained the waveform as shown. The 60-cycle voltage appears as a damped wave superimposed on the crest of each cycle.

Many other waveforms were noted but due to their complexity and lack of photographic equipment, could not be reproduced.

A further study of the output voltages was done by means of a peak vacuum-tube voltmeter, the results of which are shown in the graphs, Fig. 5 and Fig. 6. It will be seen in Fig. 5 that the output voltage rises steeply with resistance loads between 0.1-megohm and 0.5-megohm but that any further increase (in load resistance) produces very little increase in voltage.

On the other hand, Fig. 6 shows that the frequency of oscillation changes very little in spite of very wide changes in output load.

The results of these tests show then that the frequency is constant, that the output voltage may be varied from nearly zero to over 200 volts without substantially affecting the frequency and that the output voltage may be controlled by changing or varying the output load resistance. Other tests performed, included the use of a beat-frequency audio oscillator, fed into the multivibrator input at different input levels and at different frequencies.

The waveforms thus obtained were all complex but nevertheless could be synchronized, showing that the multivibrator frequency had fallen into step with the beat frequency.

TELEVISION-TYPE CIRCUITS

There are many other variations of the basic circuit shown and it is suggested that the serious experimenter devote some time to the 3 television-type sweep circuits shown in Figs. 7, 8 and 9.

These circuits are in actual use and are perhaps forerunners of the more complicated circuits of the future. Note that in Fig. 7 a form of direct coupling is used between V1 and V2. In Fig. 8 there are 2 sets of values given for each component. The values marked by an asterisk are for high-frequency use while the unmarked values are for low frequencies.

Also note that in Fig. 9 a power amplifier is used after the multivibrator in order to provide large-magnitude deflecting voltages for the larger cathode-ray tubes.

In conclusion, the writer feels that the time spent in the actual performance of these experiments will amply repay the reader later on, when television "breaks."

LIST OF PARTS

- One power transformer, midget type, P.T.1;
- One filter choke, 20 hy., L1;
- Two Cornell-Dubilier electrolytic condensers, 16 mf., 450V., C5, C6;
- Two octal sockets;
- One 4-prong socket;
- Two 6C5 metal tubes, V1, V2;
- One 80 rectifier, V3;
- One variable potentiometer, 0.1-meg., R1;
- One resistor, 0.1-meg., 1 watt, R2;
- One resistor, 10,000 ohms, 1 watt, R3;
- One resistor, 0.5-meg., 1/2-watt, R4;
- One resistor, 40 ohms, center-tapped, for filament, R5;
- One resistor, 0.5-meg., 1/2-watt, R6;
- Two Cornell-Dubilier condensers, 0.002-mf., 400V., C1, C2;
- One Cornell-Dubilier tubular paper cond., 0.25-mf., 600V., C3;
- One Cornell-Dubilier tubular paper cond., 0.006-mf., 400V., C4.

Most Radio mail order houses can supply these items if properly identified as to title of article, issue (month) of *Radio-Craft* and year.

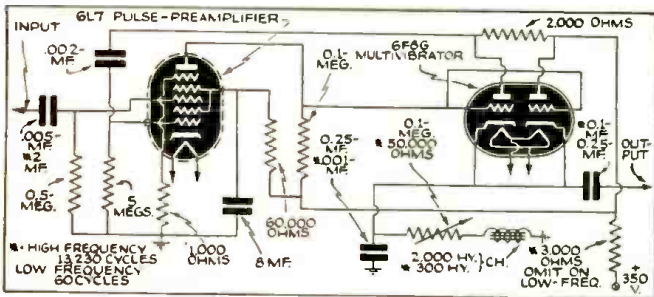

Fig. 8
Television sweep circuit incorporating the multivibrator. This circuit is suitable for the smaller C.-R. tubes.

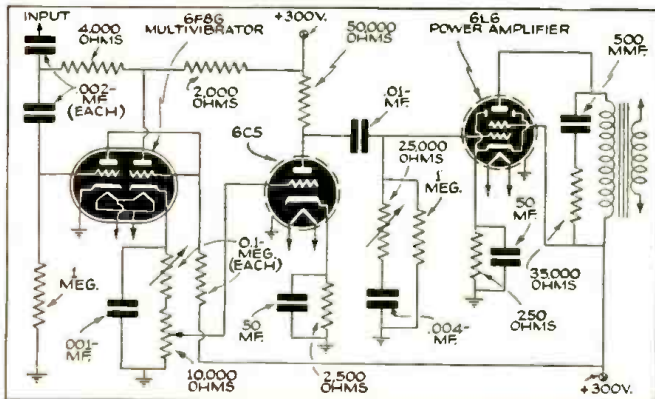

Fig. 9
Television sweep circuit with amplified multivibrator impulse. Recommended for use with the larger C.-R. tubes.

NEXT MONTH—

Infra-Red Ray Burglar Alarm; The Skin Effect Talking Lightbeam; "Farmer's Friend"—Economical Battery Set; Microwave Radio Altimeter (indicates height of plane above land as well as water!); The Phono-Radio-Piano!

Please Say That You Saw It in RADIO-CRAFT

RADOLEK

EVERYTHING IN RADIO

EVERYTHING IN RADIO

Everything in radio in this Big New 1939 RADOLEK PROFIT GUIDE. Radolek has everything under one roof. When you order, you get just what you want, promptly and economically. Over 25,000 Radio Servicemen now depend upon Radolek Service. Send for your copy of this big book. It will give you new ideas in conducting your service business on a more profitable basis.

Test Instruments—The most complete line ever displayed in any catalog. Latest improved models that provide every conceivable test necessary for thorough radio receiver analysis and repair. New push button tube testers that simplify and speed up testing time.

Over 12,000 Repair Parts, Tools, etc. Parts to repair any radio receiver made. All leading brands are represented. Every item guaranteed! And all at prices that SAVE YOU MONEY!

All Tubes Represented—RCA, Sylvania, Raytheon, Philco, etc. Includes Kellogg special Majestic types and transmitting tubes.

Complete Public Address Display. New 1939 model public address amplifiers with outputs from 10 to 90 watts. Complete P. A. Systems for permanent, Mobile and Portable installations. Powerful beam power systems attractively designed and priced for greater profits.

Latest Radio Models. The super values of 1939. New Phono-Radio combinations. Automatic tuning sets with strikingly beautiful cabinets that harmonize with all home furnishings. Also new "Ham" receivers and TRANSMITTERS!

Complete Auto Radio Section. Includes vibrator replacement guide, new auto aerials at new low prices and custom panel control plates for all automobiles. And new Delco Auto Sets that are the easiest to sell with the greatest profits.

Send for FREE catalog

The RADOLEK Co.

601 W. Randolph, Chicago, Dept. C-24

Send the Radolek Radio Profit Guide FREE.

Name

Address

Serviceman? Dealer? Experimenter?



VOLUME IX RIDER MANUAL

ON NOVEMBER 19th

ANOTHER great Rider Manual—Volume IX, covering 1938-39 American-made radio sets. Here is one of the most important volumes of them all. Every serviceman—bar none—will need it. At your finger tips are 1650 pages of the most complete and authentic compilation of service data available in the industry. Rider Manual Vol. IX features an entirely new "How It Works" Section—the most "talked-of" feature of Vol. VIII. It makes clear by practical example the complicated circuits and baffling service problems which you must cope with in repairing modern radio sets. There is also a new 140-page index. Put this great volume to work for you right away, — place your order with your jobber without delay.

- Vol. IX — \$10.00—Covering 1938-39
- Vol. VIII — \$10.00—Covering 1937-38
- Vol. IV — \$7.50—Covering 1933-34
- Vol. VII — 10.00—Covering 1936-37
- Vol. III — 7.50—Covering 1932-33
- Vol. VI — 7.50—Covering 1935-36
- Vol. II — 7.50—Covering 1931-32
- Vol. V — 7.50—Covering 1934-35
- Vol. I — 7.50—Covering 1920-31

OTHER RIDER BOOKS

- AFC SYSTEMS—144 pp. Hard Covers \$1.00
- CATHODE RAY TUBE—366 pp. 450 illus. . . . \$2.50

Other Rider Books: Servicing Superheterodynes, Aligning Philco Receivers—\$1.00 each. "Hour a Day with Rider" books on AVC Control, on Resonance & Alignment, on A-C Distribution in Radio Receivers, on D-C Distribution—60c for each book.

JOHN F. RIDER, Publisher
404 Fourth Ave.,
New York City

DID YOU SAY 9?

YOU NEED ALL 9 Rider MANUALS

YES, I SAID 9!

PLEASE NOTE

The current issue of *Radio-Craft's* contemporary publication, *Radio and Television*, contains many articles of specific interest to several classes of *Radio-Craft* readers. Among the articles of exceptional interest in the current issue are the following:

- Sound Effects in Broadcasting Studios.
- Columbia "Sets the Stage" for Television. —H. W. Secor.
- Television Eye.
- World-Wide Radio Digest.
- Mobile 5-Meter Transmitter.
- The Beginner's "Ham" Receiver—4-Tube Superhet. with Regeneration Feature—Harry D. Hooton, W8KPX.
- How to Build a T.R.F. 441-line Television Receiver—Henry Townsend.

The current December issue of *Radio and Television* is for sale on all newsstands November 10.

STATEMENT OF THE OWNERSHIP, MANAGEMENT, CIRCULATION, ETC., REQUIRED BY THE ACTS OF CONGRESS OF AUGUST 24, 1912, AND MARCH 3, 1933.

Of RADIO-CRAFT, published monthly at Springfield, Mass., for October 1, 1938.
State of New York }
County of New York } ss.

Before me, a Notary Public in and for the State and county aforesaid, personally appeared H. Gernsback, who, having been duly sworn according to law, deposes and says that he is the editor of *Radio-Craft* and that the following is, to the best of his knowledge and belief, a true statement of the ownership, management (and if a daily paper, the circulation), etc., of the aforesaid publication for the date shown in the above caption, required by the Act of August 24, 1912 and as amended by the Act of March 3, 1933, embodied in section 537, Postal Laws and Regulations, printed on the reverse of this form, to wit:

1. That the names and addresses of the publisher, editor, managing editor, and business managers are: Publisher, Radercraft Publications, Inc., 99 Hudson St., New York, N. Y.; Editor, H. Gernsback, 99 Hudson St., New York, N. Y.; Managing Editor, R. D. Washburne, 99 Hudson St., New York, N. Y.; Business Managers, none.
2. That the owner is: (if owned by a corporation, its name and address must be stated and also immediately thereunder the names and addresses of stockholders owning or holding one per cent or more of total amount of stock. If not owned by a corporation, the names and addresses of the individual owners must be given. If owned by a firm, company, or other unincorporated concern, its name and address, as well as those of each individual member, must be given.) Radercraft Publications, Inc., 99 Hudson St., New York, N. Y.; H. Gernsback, 99 Hudson St., New York, N. Y.

3. That the known bondholders, mortgagees, and other security holders owning or holding 1 per cent or more of total amount of bonds, mortgages, or other securities are: (if there are none, so state.) None.

4. That the two paragraphs next above, giving the names of the owners, stockholders, and security holders, if any, contain not only the list of stockholders and security holders as they appear upon the books of the company but also, in cases where the stockholder or security holder appears upon the books of the company as trustee or in any other fiduciary relation, the name of the person or corporation for whom such trustee is acting, is given; also that the said two paragraphs contain statements embracing affiant's full knowledge and belief as to the circumstances and conditions under which stockholders and security holders who do not appear upon the books of the company as trustees, hold stock and securities in a capacity other than that of a bona fide owner; and this affiant has no reason to believe that any other person, association, or corporation has any interest direct or indirect in the said stock, bonds, or other securities than as so stated by him.

5. That the average number of copies of each issue of this publication sold or distributed, through the mails or otherwise, to paid subscribers during the twelve months preceding the date shown above is: (This information is required from daily publications only.)

H. GERNSBACK, Publisher.
Sworn to and subscribed before me this 30th day of Sept., 1938.

MAURICE COYNE, Notary Public.
Notary Public, N. Y. Co. No. 562
(My commission expires March 30, 1940.)

Index to advertisers

A	
Allied Radio Corporation.....	363
The American Red Cross.....	360
Amperite Corporation.....	Inside Front Cover
Amplifier Co. of America.....	372
Arcturus Radio Tube Co.....	369
Arrow Sales Company.....	370
B	
Herman J. Bernard.....	368
The Brush Development Co.....	361
Burstein-Applebee Company.....	370
C	
Capitol Radio Engineering Inst.....	371, 381
Central Radio Labs.....	362
Classified Section.....	380, 381
Clough-Ironside Company.....	372
Cornell-Dubilier Corp.....	352B
Cornish Wire Company.....	381
Coyne Electrical School.....	323
E	
Eastman & Majestic Hotels.....	378
G	
Gold Shield Products Co.....	377
H	
Hammarlund Mfg. Company.....	364
Hickok Elect. Instrument Co.....	379
Hudson Specialties Company.....	380
Hygrade Sylvania Corporation.....	362
K	
Kelsey Company.....	370
L	
Lancaster, Allwine & Rommel.....	371
Leotone Radio Company.....	363
Lincoln Engineering School.....	372
M	
Meissner Mfg. Company.....	Back Cover
Modell's.....	372
N	
National Plans Institute.....	365
National Radio Institute.....	321
National Schools.....	363
National Tuberculosis Assoc.....	374
National Union Radio Corp.....	371
New York Radio Supply Co.....	374
New York YMCA Schools.....	360
R	
Radio Circular Company.....	378
Radio City Products Co.....	367
Radio Servicemen of America, Inc.....	376
Radio & Tech. Publishing Co.....	360, 366
Radolek Company.....	383
RCA Institutes, Inc.....	370
RCA Manufacturing Co.....	371
Readrite Meter Works.....	370
Reliable Radio Company.....	376
Remington Rand, Inc.....	371
John F. Rider.....	384
S	
Service Instruments, Inc.....	365
Solar Mfg. Company.....	361
Sprague Products Company.....	370
Sprayberry Academy of Radio	Inside Back Cover
Supreme Instruments Corp.....	361
T	
Technifax.....	381
Teletran Products Company.....	379
Test Equipment Co. of America.....	374
Triplett Elec. Instrument Co.....	375
Try-Mo Radio Co., Inc.....	366
U	
United Radio Company.....	374
W	
Montgomery Ward & Co.....	377
Wellworth Trading Company.....	364, 372
Weston Elect. Instrument Corp.....	352A
Wholesale Radio Service Co., Inc.....	359, 373
Wright-DeCoster, Inc.....	369

(While every precaution is taken to insure accuracy, we cannot guarantee against the possibility of an occasional change or omission in the preparation of this index.)

New RADIO HOME-STUDY IDEA

UP TO THE MINUTE AS A STREAMLINER..



SPRAYBERRY

Personalized TRAINING in RADIO

HOW TO MAKE MONEY IN RADIO
 SPRAYBERRY ACADEMY OF RADIO

Get my **FREE BOOK** FOR AMAZING DETAILS

WITH THIS SENSATIONAL METHOD
YOU CAN LEARN RADIO—QUICKLY
MAKE GOOD PROFITS—SOON

I ACTUALLY SET YOU UP FOR YOUR OWN BUSINESS

Here's a brand-new, altogether different type of Radio Education that's specially designed to give you intense, practical, quick training . . . for a money-making career in the fast-moving Radio Industry. Moreover, I back you up all the way with close personal attention. This is not an idle promise.

I insist that you write me for special help on any subject or work that is not perfectly clear and understandable to you . . . not only while you are learning—but after you have completed my Course and are actually working in Radio. Now let me show you how I equip you for your own business.



THESE SPRAYBERRY GRADUATES ARE ENJOYING RAPID ADVANCEMENT WITH BIG FUTURE AHEAD

Deluged with Work
 Edwin A. Gammon, Auburn, Me., writes: "Your Course is so thoroughly good and practical that it is hard to pick out one part that is better than any other. Due to the knowledge I have gotten from it, I have been deluged with work for the last month, achieving good results with radios which had been unsatisfactorily tackled by other servicemen. You deserve all the credit."

"Cleared" \$150 in Spare Time
 A. H. Langle, Northridge, Mass., writes: "Since enrolling I have cleared a net profit of more than \$150 in spare time alone . . . and I am not one-half through the course yet. Honestly, I cannot understand how you can give so much 'dope' for so little money."

NO PREVIOUS EXPERIENCE NEEDED
 My training starts right at the beginning of Radio . . . unfolds each subject in a simplified, logical, understandable style. You easily learn all about Television, Electronics, Police Radio, Ship Radio, Commercial Radio Broadcasting . . . Radio Set Repair and Installation Work, etc. Every essential subject of Radio is covered.

QUIT DREAMING! MAKE A FUTURE FOR YOURSELF
 Prepare for a Good Paying Job
 No matter if you desire to BE YOUR OWN BOSS in your own business . . . or hold down a good job in Radio, my Training will give you the useful information and knowledge to win success. It is easy enough to sit idly by and envy those fellows who have good-paying jobs and are building toward splendid incomes and real security in the future. BUT THESE FELLOWS ARE NO SMARTER THAN YOU. The essential difference is that they have taken the initiative to pull themselves up by their own bootstraps. You can do the same thing. Don't just "wish" for more money . . . start training for it—RIGHT NOW.

REMEMBER—THE SPRAYBERRY COURSE IS SOLD UNDER AN IRON-CLAD, MONEY-BACK AGREEMENT



You get real **PROFESSIONAL EQUIPMENT** to handle money-making spare time jobs

I PROVIDE YOU WITH THE FINEST EQUIPMENT OFFERED WITH ANY RADIO COURSE. With this equipment, you will be able to get into the money-making side of Radio by doing actual Radio Service work shortly after you begin your Training. You'll learn how to put these Testing Units and Tools to money-making use through the valuable spare-time **BUSINESS BUILDERS** I supply. **BUSINESS BUILDERS** will show you where the Radio Service jobs are . . . right in your own neighborhood, they show you how to do these jobs. You will be able to make practical application of the theories learned and practical use of the equipment supplied. Moreover, you'll get invaluable practical experience and add to your bank account at the same time.

EXPERIMENTAL OUTFITS GIVEN

These will enable you to carry out interesting, practical experiments that will make the theory of Radio crystal clear to you. Don't forget . . . what you learn by working with your own hands, you always remember—and that's the Sprayberry method.

YOU RECEIVE PERSONAL COACHING SERVICE ALL THE WAY

RUSH THIS COUPON for Big FREE Book

SERVICEMEN!

I offer special Advanced Training for those already in Radio. I'll show you the newest methods . . . newest circuits and short-cuts. I'll show you how to do the jobs other Radio men can't handle . . . how to really cash in on your ability. Complete details of this Advanced Course and Fundamental Course, Features, etc., fully described in my new 48-page **FREE BOOK.**

DON'T DELAY!

SPRAYBERRY ACADEMY OF RADIO Act Now
 F. L. Sprayberry, Pres.
 120-M University Place, N. W.
 Washington, D. C.

Please send me **FREE** copy of "HOW TO MAKE MONEY IN RADIO."

NAME AGE

ADDRESS

CITY STATE

Tear off this coupon, mail in envelope or paste on penny postcard. (Servicemen—Check Here)

Exactly what you need for **QUICK ADVANCEMENT in RADIO**

3 TUBE KIT

**IT'S FUN TO BUILD IT
IN ONE EVENING!**

These new Meissner Kits are remarkable little radio receivers—efficient in operation—and very easy to assemble.

This 3-Tube Model will operate a magnetic or permanent-magnet speaker. Utilizes the very last word in battery set engineering—the 1½-volt series of tubes! Has three controls—tuning, regeneration and volume.

Each Kit comes to you in a package—complete with all parts necessary for the construction of a complete receiver including panel, chassis, sockets, resistors, condensers, wire, hardware and a broadcast band plug-in coil. Does not include tubes, batteries or speaker.

And it is guaranteed to work or **\$3.75**
Meissner will fix it for you!

1-TUBE KIT!

Same as Model described above except no volume control. Operates a headphone. **\$3.00**

2-TUBE KIT!

A practical little 1-Tube receiver that really works. Looks like the illustration except no volume control. Operates a headphone. **\$2.70**

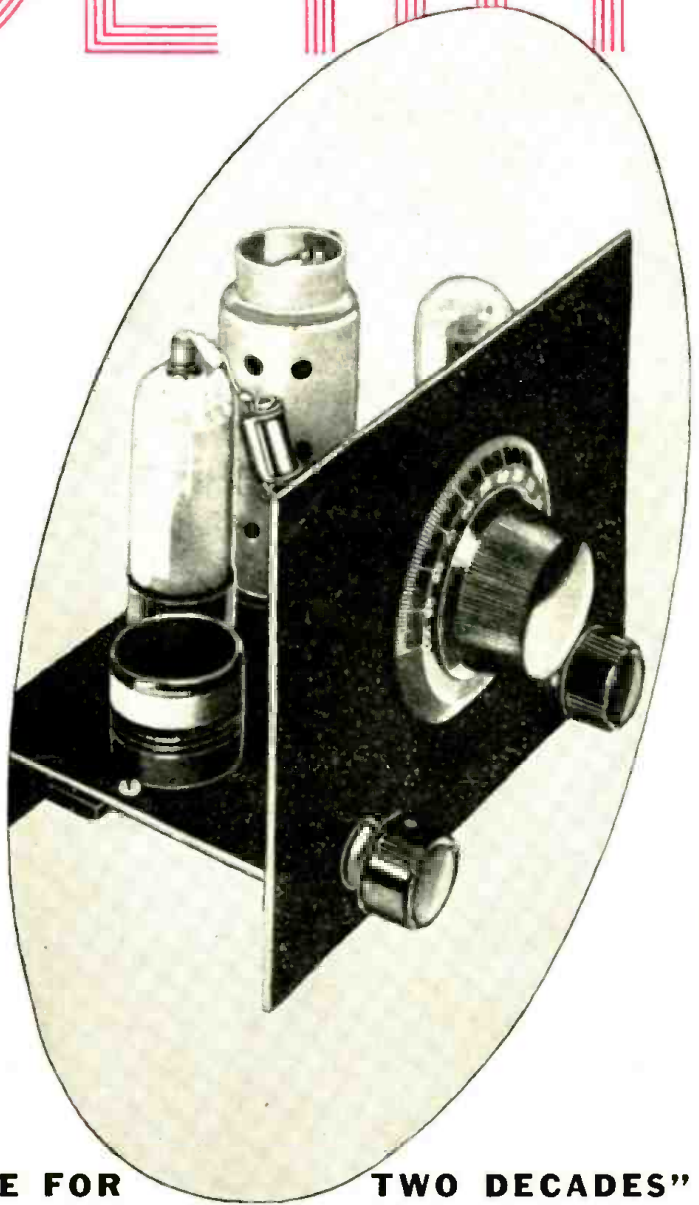

“A FAMOUS NAME FOR TWO DECADES”

MAIL COUPON!

MEISSNER MFG. CO., Dept. RC-12
Mt. Carmel, Illinois

Please rush me information on

3, 2 and 1-Tube Kits
 Larger Kits

Name

Address

City State

ASK YOUR PARTS JOBBER

Meissner

MT. CARMEL, ILL.